

UNDERSTANDING SOUND POWER AND MICROPHONE RESPONSE



A COMPLETE GUIDE TO ACOUSTIC FUNDAMENTALS



TABLE OF CONTENTS

SOUND PRESSURE LEVEL, SOUND INTENSITY, & SOUND POWER	4 - 5
ACOUSTIC PROPERTIES & FORMULAS	6 - 7
SOUND PERCEPTION & WEIGHTING FILTERS	8 - 9
MICROPHONES, PREAMPLIFIERS, CABLES, & POWER SUPPLY	10 - 11
MICROPHONE RESPONSE	12 - 13
MICROPHONE DYNAMICS & FREQUENCY RANGE BY SIZE AND SENSITIVITY	14 - 15

SOUND PRESSURE LEVEL, SOUND INTENSITY, & SOUND POWER

SOUND PRESSURE LEVEL

Sound Pressure Level (SPL) is defined as: $SPL = L_p = 10 \log \left(\frac{P_{rms}^2}{P_{ref}^2} \right)$ $P_{ref} = \begin{cases} 20 \mu Pa \text{ in air} \\ 1 \mu Pa \text{ in water} \end{cases}$

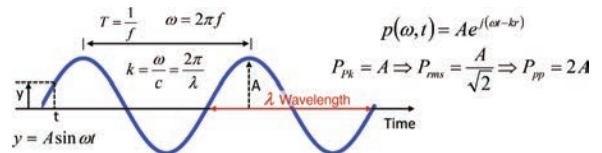
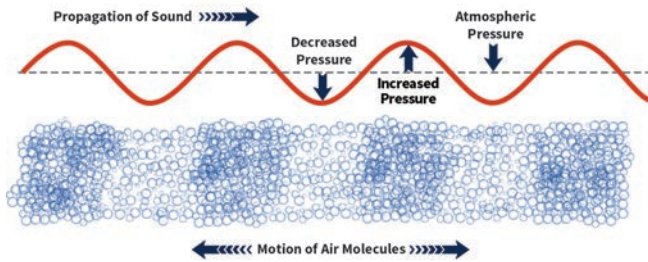

$$\lambda = \frac{c}{f}$$

λ is wavelength (in meters)
 c is the speed of sound (in meters/seconds)
 f is frequency (in hertz)

SOUND INTENSITY

I = Time-averaged intensity; defined by the time-averaged rate of energy transmission through a unit area normal to the direction of propagation.

$$I = \frac{1}{T} \int_0^T P v dt = \frac{1}{2} \text{Re}(P v^*) = \frac{|P|^2}{\rho_0 c} = \frac{\pm P_{rms}^2}{\rho_0 c}$$

Approximation for plane waves and spherical waves in the far field.

- T = The period of one cycle of a monofrequency harmonic sound wave.
- v = Particle velocity.
- The sign (\pm) is based on the direction of propagation.

Sound Intensity Level (SIL or LI) is the intensity level in decibels, where I_0 is the reference intensity.

$$SIL = L_I = 10 \log \frac{I}{I_0}$$

I_0 = The reference intensity that represents the auditory threshold of human hearing.

$$I_0 = \frac{p_0^2}{\rho_0 c} = \frac{(20 \times 10^{-6} Pa)^2}{\approx 400 \frac{N \cdot s}{m}} = 10^{-12} \frac{W}{m^2}$$

SOUND POWER

Sound power (W) is the rate of energy transmission per unit time. It represents all of the energy radiated from an acoustic source within a specified time interval.

$$W = \int I dA = \sum_n I_n dA$$



INVERSE SQUARE LAW

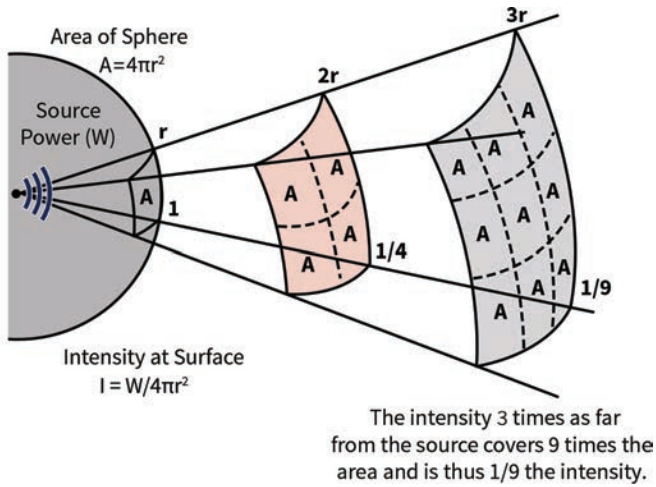

W = Acoustic power; defined as the time-averaged rate of sound energy transmission from the source.

I = Acoustic intensity; defined as the time-averaged rate of sound energy transmission through a unit area, normal to the direction of propagation.

PRESSURE AND PARTICLE VELOCITY PHASE

Phase Shift 0°

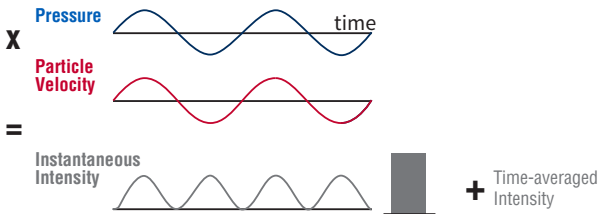

- Average sound intensity is positive
- Wave propagates in positive direction
- Active sound power field

Phase Shift 180°

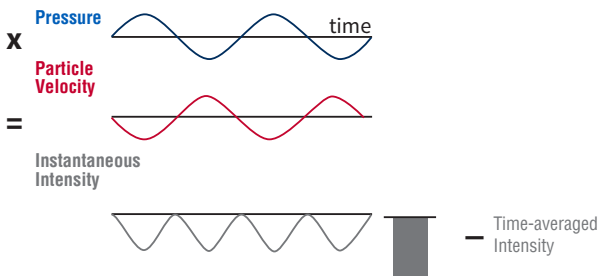

- Average sound intensity is negative
- Wave propagates in a negative direction
- Active sound power field

Phase Shift 90°

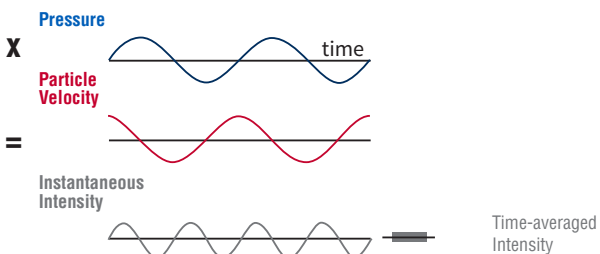

- Average sound intensity is zero
- Wave does not propagate (standing wave)
- Active sound power field

ACOUSTIC PROPERTIES & FORMULAS

PROPERTIES & LAWS

P = Acoustic pressure; defined as the force per unit area resulting from the propagation of sound. The International System of Units (SI) unit for pressure is Pascals (Pa). A Pascal is equal to one Newton per square meter (N/m^2), where the Newton is the SI unit for force.

I = Acoustic intensity; defined as the time-averaged rate of sound energy transmission through a unit area, normal to the direction of propagation. Intensity may be expressed in SI units as Watts (W) per square meter, where the Watt is the SI unit for power.

v = Particle velocity; defined as the magnitude and direction of a change in particle position per unit time. A particle is an infinitesimal volume of the medium through which sound propagates. The SI unit for velocity is meters per second.

z = Specific acoustic impedance; defined as the ratio of pressure to particle velocity. It is a characteristic of the medium and of the type of wave being propagated. Specific acoustic impedance may be expressed in SI units as Newton seconds per cubic meter.

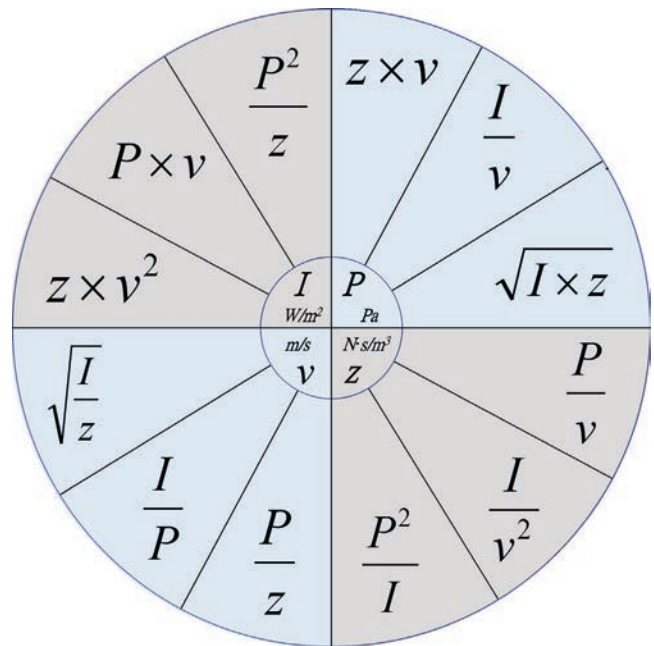

Acoustic Properties of Fluids					
Liquid	Density	Ratio of Specific Heats	Modulus	Sound Speed	Characteristic Impedance
	kg/m ³		Bulk		
	ρ_0	γ	Pa x 10 ⁹	m/s	Pa·s/m x 10 ⁶
Fresh Water at 20°C	998	1.004	2.18	1481	1.48
Salt Water at 13°C	1026	1.010	2.28	1500	1.54
Turpentine at 20°C	870	1.27	1.07	1250	1.11
Mercury at 20°C	13600	1.13	25.3	1450	19.7
Gas	Density	Ratio of Specific Heats	Specific Heat	Sound Speed	Characteristic Impedance
	kg/m ³		J/kg·K		
	ρ_0	γ	C_p	m/s	Pa·s/m x 10 ⁶
Air at 20°C	1.21	1.40	1.01	343	415
Air at 0°C	1.29	1.40	---	332	429
Steam at 100°C	0.6	1.32	---	405	242
O ₂ at 0°C	1.43	1.40	0.91	317	453
CO ₂ at 0°C	1.98	1.30	0.84	258	512
H ₂ at 0°C	0.090	1.41	14.2	1270	114
Xenon at 20°C	5.76	1.65	0.16	178	1025

- ρ_0 = density
- Gases: γ = ratio of specific heats, P_0 = total pressure
- Liquids: γ = ratio of specific heats, B_T = isothermal bulk modulus

$$c_{Liquid} = \sqrt{\frac{\gamma B_T}{\rho_0}} = \text{Speed of Sound in Liquid}$$

$$c_{Gas} = \sqrt{\frac{\gamma P_0}{\rho_0}} = \text{Speed of Sound in Gas}$$

DECIBEL ADDITION - COHERENT INCOHERENT

Coherent signals have the same frequency and constant relative phase. The dotted black line on the graph to the right is used to estimate the sound pressure level of multiple coherent sound sources when the relative phase between them is zero degrees.

Incoherent signals have different frequencies or random differences in relative phase. The blue solid line on the graph to the right is used to estimate the sound pressure level of multiple incoherent sound sources.

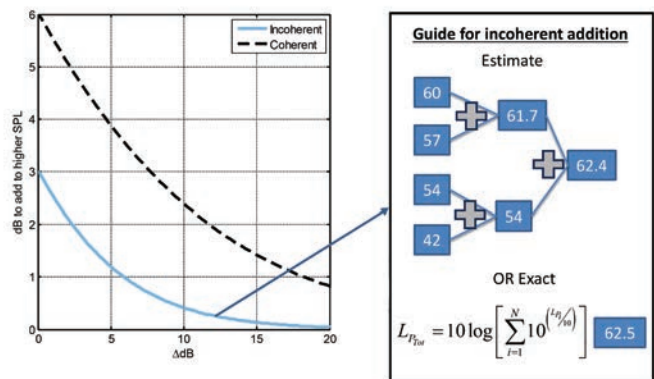

SOUND PERCEPTION & WEIGHTING FILTERS

FREQUENCY RANGE SPECTRUM

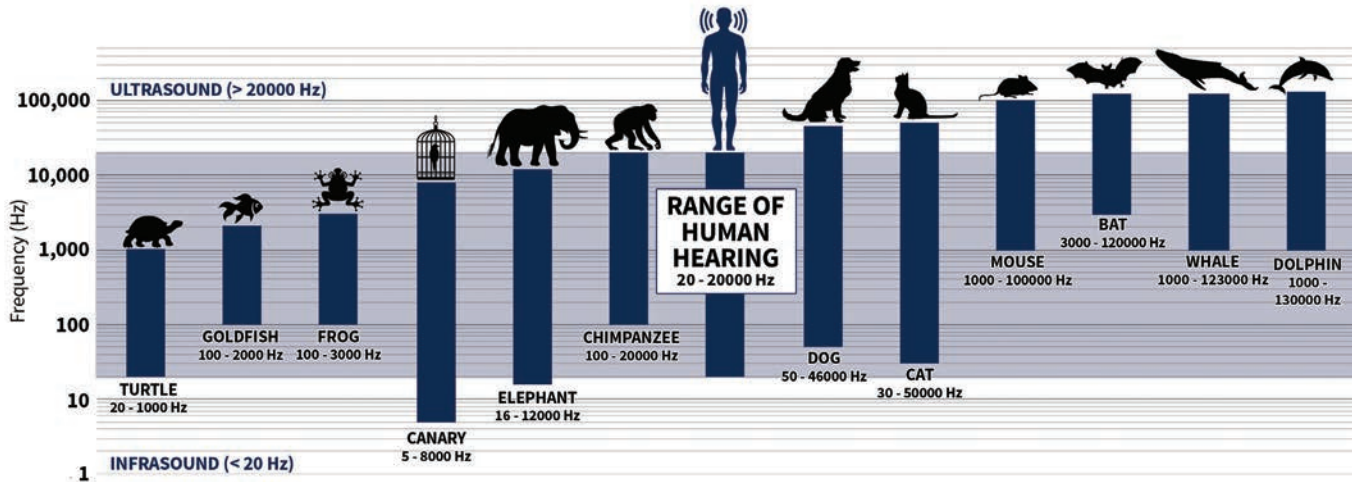

THE AUDIBLE RANGE OF THE HUMAN EAR

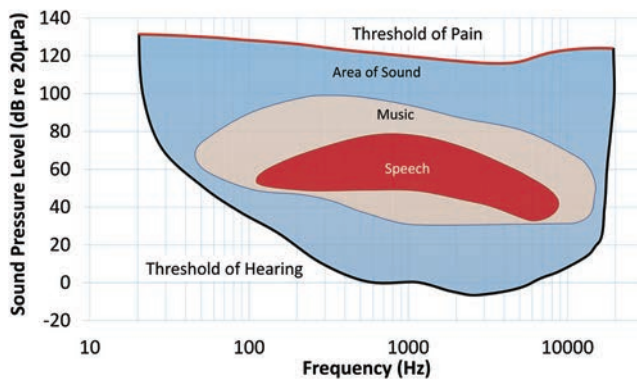

EQUAL LOUDNESS CONTOURS

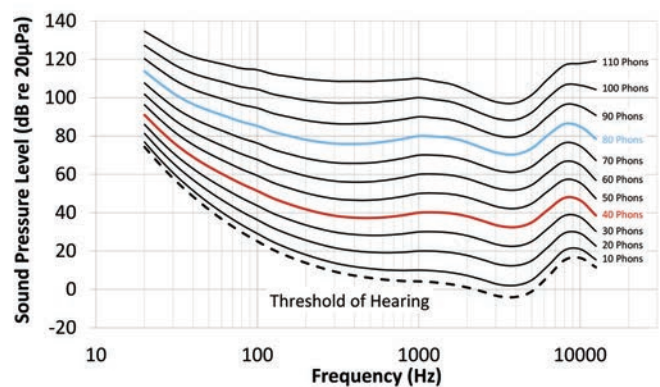

COMMON WEIGHTING FILTERS

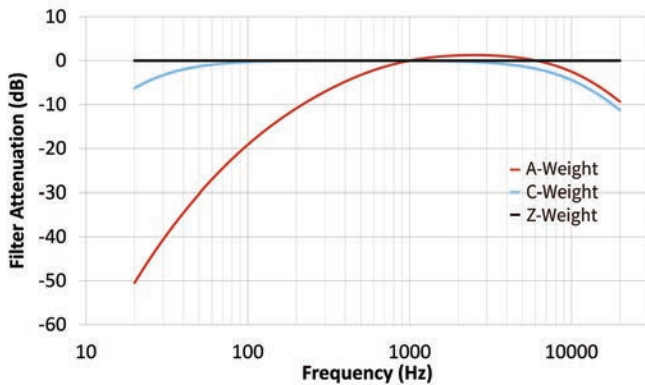

A-weight represents how humans perceive midrange sound pressure level at different frequencies. C-weight represents how humans perceive high amplitude sound pressure levels. Z-weight is a linear or unweighted representation of sound pressure levels.

Limits for Permissible Noise Exposure		
Time to 100% Noise Dose	OSHA (US) Exposure Level	EU Exposure Level
8 Hours	90 dBA	87 dBA
6 Hours	92 dBA	88 dBA
4 Hours	95 dBA	90 dBA
3 Hours	97 dBA	91 dBA
2 Hours	100 dBA	93 dBA
1.5 Hours	102 dBA	94 dBA
1 Hour	105 dBA	96 dBA
30 Minutes	110 dBA	99 dBA
15 Minutes	115 dBA	102 dBA

Noise Dose is the measured Sound Exposure Level normalized to an 8-hour work day. Exposure to sound pressure is regulated.

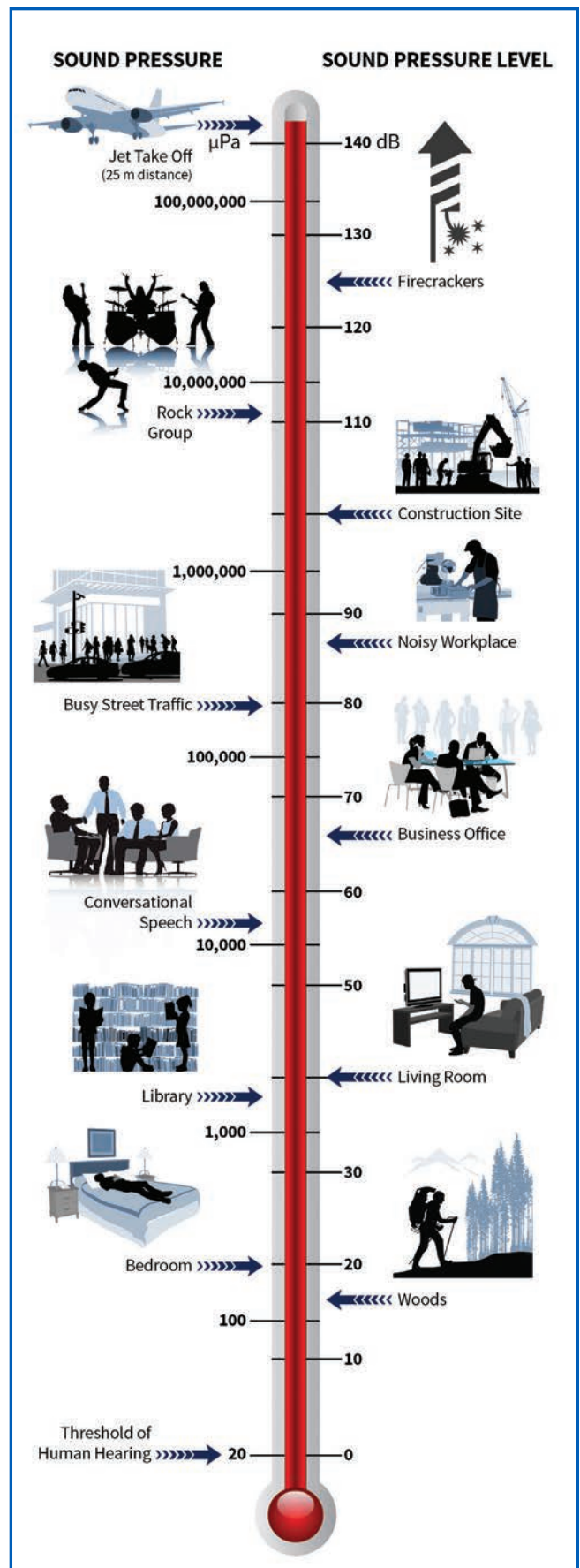

MICROPHONES, PREAMPLIFIERS, CABLES, & POWER SUPPLY

EXTERNALLY POLARIZED VS. PREPOLARIZED

Externally Polarized Microphones:

- Require 200 volts applied directly to the backplate.
- Require specialized signal conditioning that supplies power to the amplifier and the polarization voltage required to operate the microphone, thus making modular systems, such as sound level meters, difficult to power.
- Require a multiple wire system. Each wire in the cable provides power, grounding, signal, and polarization from the signal conditioner to the preamplifier.

Externally Polarized

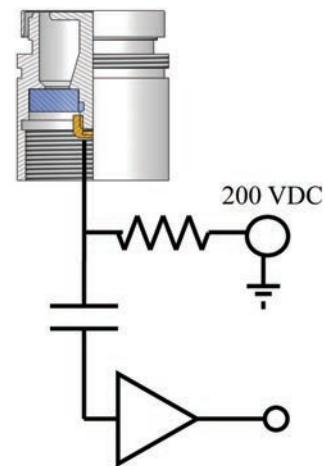

Prepolarized Microphones:

- Use a permanent charge equivalent to -200 volts embedded into the electret on the backplate.
- Simplify the design of the preamplifier making ICP® two-wire microphone systems possible.
- May be combined with ICP® systems that are easily interchanged with other test and measurement sensors as well as multimode preamplifiers that are used with externally polarized microphones with the polarization voltage turned off.
- Generally have lower per channel cost than externally polarized systems.
- Can be used with many available data acquisition systems without additional signal conditioning.

Prepolarized

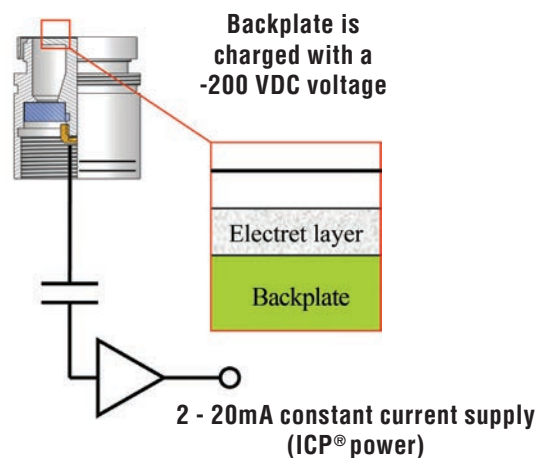

MEASUREMENT CHAIN



EXTERNALLY POLARIZED MICROPHONE SYSTEM



PREPOLARIZED MICROPHONE SYSTEM



PHANTOM POWERED MICROPHONE SYSTEM

CONNECTOR PIN-OUTS

7-Pin LEMO® Connector 1B (Outside View)

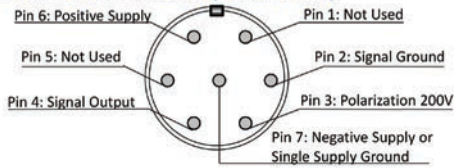

Voltage Supply: Single 28V - 120V or Dual ±14V - ±60V

Externally Polarized (200 V)



BNC (Outside View, SMB and 10-32 not shown)

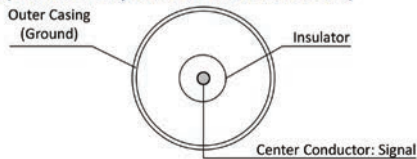

Voltage Supply: Typically 5 - 14 VDC

Prepolarized (0 V)



3-Pin XLR Connector (Outside View)

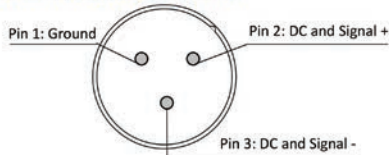

Voltage Supply: 48 VDC, 24 VDC, or 12 VDC

Phantom Power (48 V)



MICROPHONE RESPONSE

DIRECTIONAL RESPONSE 1/2" FREE-FIELD MICROPHONE SYSTEM

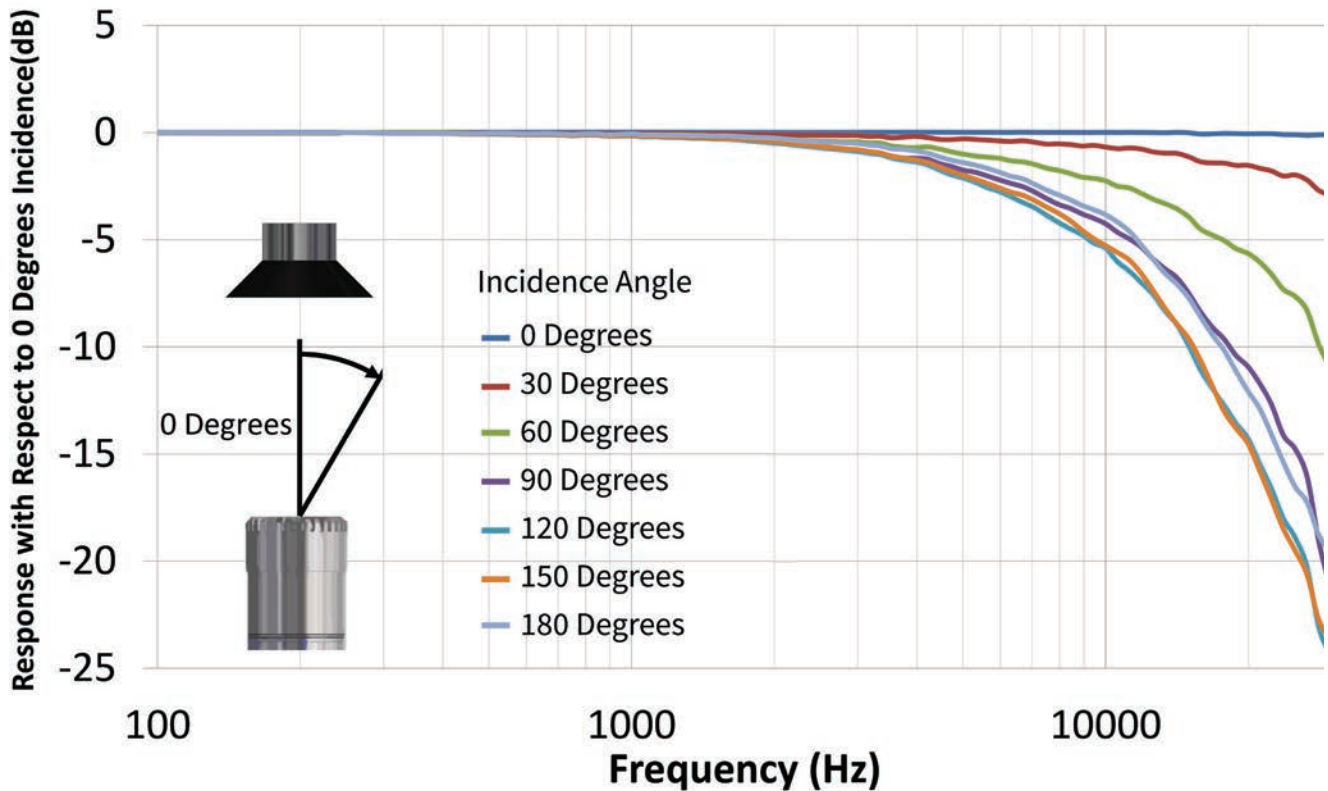

DIRECTIVITY

- Polar patterns show the change in sensitivity of the sensor as a function of azimuth angle referenced to the sensitivity at zero degrees incidence.
- Microphones that are very small compared to a wavelength of sound will be more omnidirectional. At low frequencies (less than 2 kHz) nearly all microphones are omnidirectional because of the much larger wavelengths. The wavelength of sound in air at 2 kHz at standard temperature and pressure is 6.8 in (17.2 cm), which is roughly 14x the diameter of a 1/2" microphone.
- A common parameter for characterizing polar patterns is beamwidth. The beamwidth in degrees is usually given to be the angle between the half-power (-3 dB) points of the main lobe. If the sound power emitted from the source is constant; at higher frequencies the polar pattern will be narrower.

TYPICAL MICROPHONE POLAR PLOT

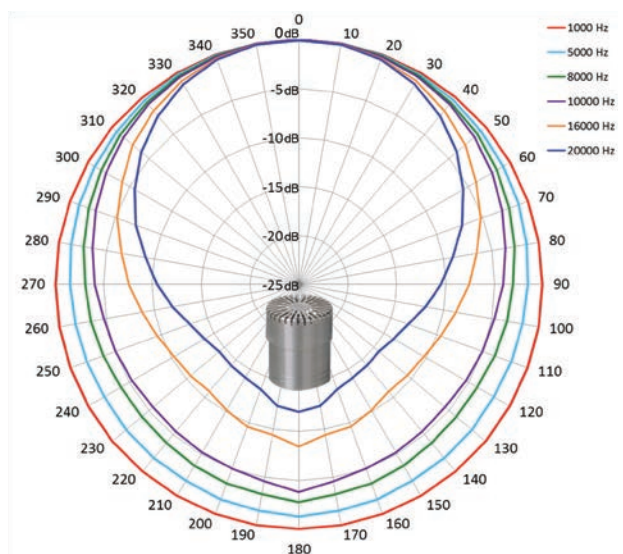

TYPICAL RESPONSES OF A ½" FREE-FIELD MICROPHONE

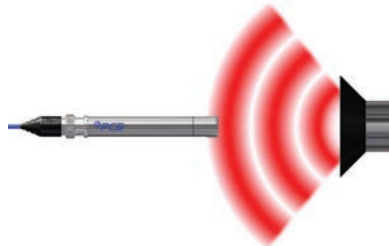
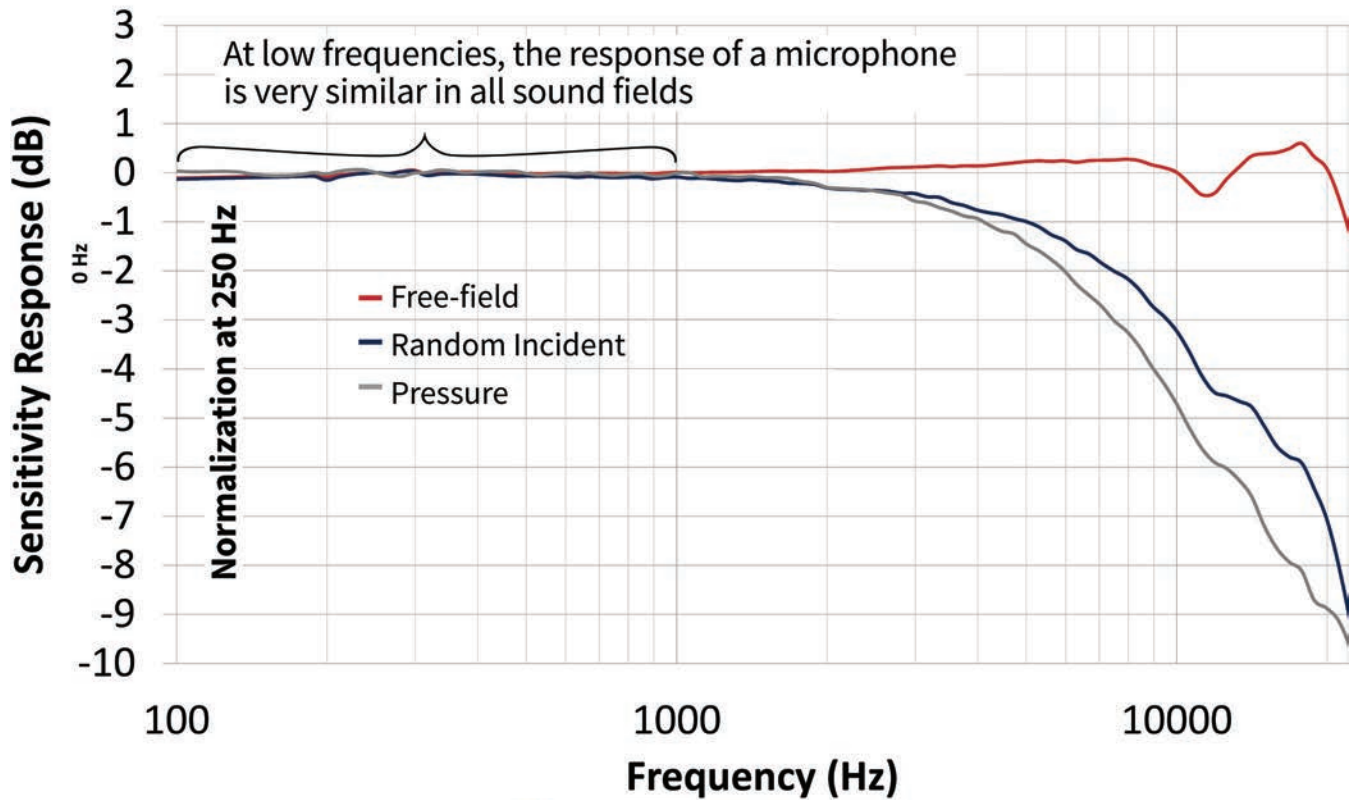

Free-field Response is the response of a microphone with respect to a single source normal to the microphone diaphragm in a free (non-reflecting) sound field.

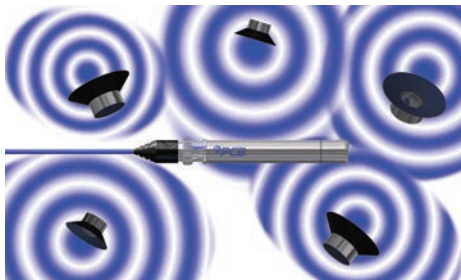

Random Incidence Response is the response of a microphone with respect to a sound field with multiple sources in multiple directions.

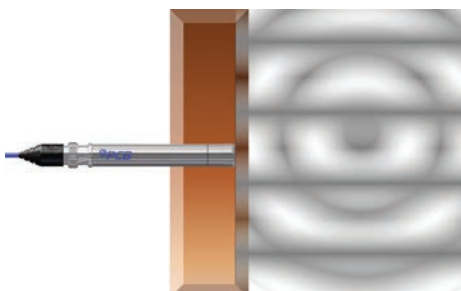

Pressure Response is the response of a microphone when it is used like a pressure transducer, flush mounted in a wall, coupler or duct.

MICROPHONE DYNAMICS & FREQUENCY RANGE BY SIZE AND SENSITIVITY

INHERENT NOISE

1/2" Microphone, Z-weighted (Linear)

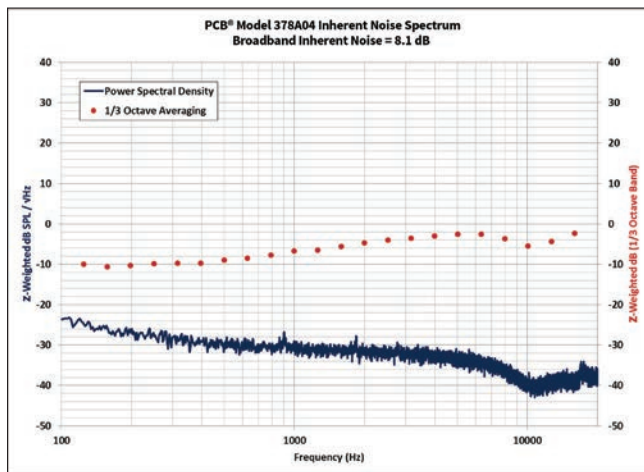

1/4" Microphone, A-weighted

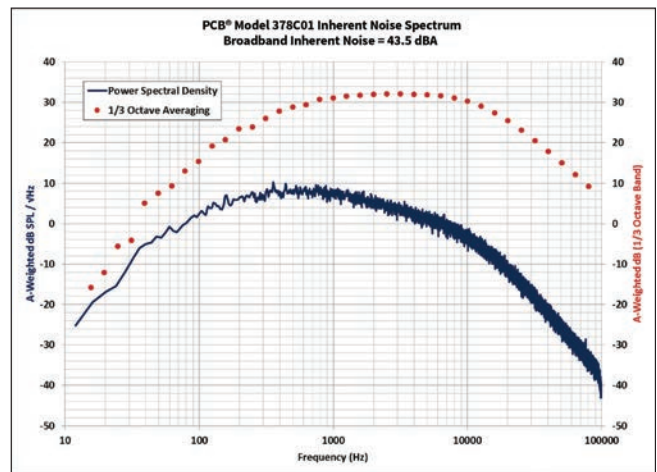

- Power spectral density represents the mean square value of the energy per unit frequency, independent of the bin width.
- Octave band values represent the mean square value of the energy in a group of frequencies. The bandwidths are established by a center frequency with lower and upper limits. ISO 266:1997 (E) establishes an international standard of preferred octave band frequencies for acoustic measurements.
- Broadband inherent noise provides a single mean square value representing the energy across the entire measured bandwidth.
- Octave band values increase with increasing frequency because the width of the octave band is a constant percentage of the center frequency and therefore the number of frequencies within each octave band.
- Broadband and octave band values are larger than power spectral density values because more energy is contained in the band.

HARMONIC DISTORTION

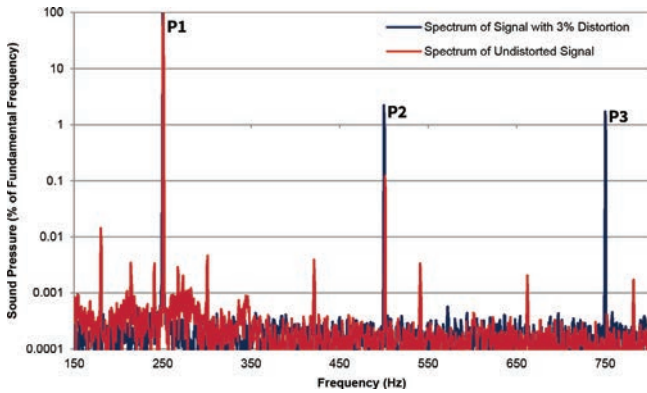

- The output voltage range of some preamplifiers may cause the system to clip, reducing the usable high amplitude range of the microphone. Clipping occurs abruptly when the maximum voltage output of the preamplifier is exceeded.
- The upper limit of dynamic range is typically defined by either the sound pressure level required to produce 3% THD of the system or the sound pressure level required to exceed the output voltage limit of the preamplifier, whichever comes first.

- Total Harmonic Distortion (THD) of a system is the ratio of the root-mean-square sum of all of the powers of all of the harmonic frequencies to the power of the fundamental frequency.
- P1 is the sound pressure associated with the fundamental frequency of interest and P2, P3, etc. are the sound pressures associated with each subsequent harmonic.
- For microphones, the 3% THD is often stated in the specification as an indication of the upper usable sound pressure. THD is affected by the preamplifier, which changes the sound pressure level where 3% THD occurs.
- A microphone can be used beyond the 3% THD, but the output will be more nonlinear, and the measured sound pressure levels will be less accurate.

Sine Wave

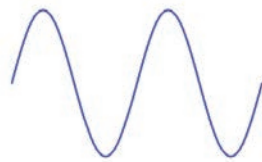

Clipping



MICROPHONE COMPARISON

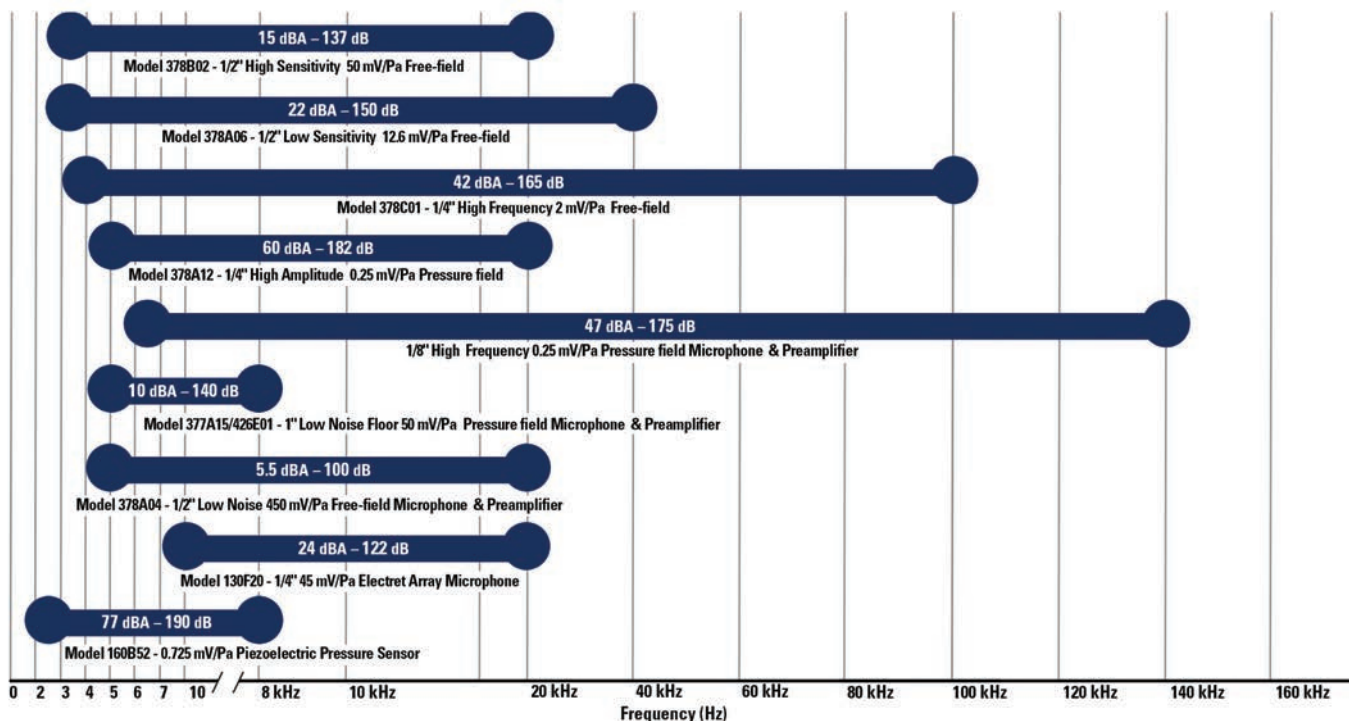



3425 Walden Avenue, Depew, NY 14043 USA

pcb.com | info@pcb.com | 800 828 8840 | +1 716 684 0001

© 2021 PCB Piezotronics - all rights reserved. PCB Piezotronics is a wholly-owned subsidiary of Amphenol Corporation. Endevo is an assumed name of PCB Piezotronics of North Carolina, Inc., which is a wholly-owned subsidiary of PCB Piezotronics, Inc. Accumetrics, Inc. and The Modal Shop, Inc. are wholly-owned subsidiaries of PCB Piezotronics, Inc. IMI Sensors and Larson Davis are Divisions of PCB Piezotronics, Inc. Except for any third party marks for which attribution is provided herein, the company names and product names used in this document may be the registered trademarks or unregistered trademarks of PCB Piezotronics, Inc., PCB Piezotronics of North Carolina, Inc. (d/b/a Endevo), The Modal Shop, Inc. or Accumetrics, Inc. Detailed trademark ownership information is available at www.pcb.com/trademarkownership.

TM-AC-PosterBook-1221