



Model 208M133

Multi-purpose, ICP® force sensor, 500 lb comp., 500 lb tension, 10 mV/lb

Installation and Operating Manual

**For assistance with the operation of this product,
contact the PCB Piezotronics, Inc.**

Toll-free: 716-684-0001

24-hour SensorLine: 716-684-0001

Fax: 716-684-0987

E-mail: info@pcb.com

Web: www.pcb.com



Repair and Maintenance

PCB guarantees Total Customer Satisfaction through its “Lifetime Warranty Plus” on all Platinum Stock Products sold by PCB and through its limited warranties on all other PCB Stock, Standard and Special products. Due to the sophisticated nature of our sensors and associated instrumentation, **field servicing and repair is not recommended and, if attempted, will void the factory warranty.**

Beyond routine calibration and battery replacements where applicable, our products require no user maintenance. Clean electrical connectors, housings, and mounting surfaces with solutions and techniques that will not harm the material of construction. Observe caution when using liquids near devices that are not hermetically sealed. Such devices should only be wiped with a dampened cloth—never saturated or submerged.

In the event that equipment becomes damaged or ceases to operate, our Application Engineers are here to support your troubleshooting efforts 24 hours a day, 7 days a week. Call or email with model and serial number as well as a brief description of the problem.

Calibration

Routine calibration of sensors and associated instrumentation is necessary to maintain measurement accuracy. We recommend calibrating on an annual basis, after exposure to any extreme environmental influence, or prior to any critical test.

PCB Piezotronics is an ISO-9001 certified company whose calibration services are accredited by A2LA to ISO/IEC 17025, with full traceability to SI through N.I.S.T. In addition to our standard calibration services, we also offer specialized tests, including: sensitivity at elevated or cryogenic temperatures, phase response, extended high or low frequency response, extended range, leak testing, hydrostatic pressure testing, and others. For more information, contact your local PCB Piezotronics distributor, sales representative, or factory customer service representative.

Returning Equipment

If factory repair is required, our representatives will provide you with a Return Material Authorization (RMA) number, which we use to reference any information you have already provided and expedite the repair process. This number should be clearly marked on the outside of all returned package(s) and on any packing list(s) accompanying the shipment.

Contact Information

PCB Piezotronics, Inc.
3425 Walden Ave.
Depew, NY14043 USA
Toll-free: (800) 828-8840
24-hour SensorLine: (716) 684-0001
General inquiries: info@pcb.com
Repair inquiries: rma@pcb.com

For a complete list of distributors, global offices and sales representatives, visit our website, www.pcb.com.

Safety Considerations

This product is intended for use by qualified personnel who recognize shock hazards and are familiar with the precautions required to avoid injury. While our equipment is designed with user safety in mind, the protection provided by the equipment may be impaired if equipment is used in a manner not specified by this manual.

Discontinue use and contact our 24-Hour Sensorline if:

- Assistance is needed to safely operate equipment
- Damage is visible or suspected
- Equipment fails or malfunctions

For complete equipment ratings, refer to the enclosed specification sheet for your product.

Definition of Terms and Symbols

The following symbols may be used in this manual:



DANGER

Indicates an immediate hazardous situation, which, if not avoided, may result in death or serious injury.

**CAUTION**

Refers to hazards that could damage the instrument.

**NOTE**

Indicates tips, recommendations and important information. The notes simplify processes and contain additional information on particular operating steps.

The following symbols may be found on the equipment described in this manual:



This symbol on the unit indicates that high voltage may be present. Use standard safety precautions to avoid personal contact with this voltage.



This symbol on the unit indicates that the user should refer to the operating instructions located in the manual.



This symbol indicates safety, earth ground.



PCB工业监视和测量设备 - 中国RoHS2公布表

PCB Industrial Monitoring and Measuring Equipment - China RoHS 2 Disclosure Table

部件名称	有害物质					
	铅 (Pb)	汞 (Hg)	镉 (Cd)	六价铬 (Cr(VI))	多溴联苯 (PBB)	多溴二苯醚 (PBDE)
住房	0	0	0	0	0	0
PCB板	X	0	0	0	0	0
电气连接器	0	0	0	0	0	0
压电晶体	X	0	0	0	0	0
环氧	0	0	0	0	0	0
铁氟龙	0	0	0	0	0	0
电子	0	0	0	0	0	0
厚膜基板	0	0	X	0	0	0
电线	0	0	0	0	0	0
电缆	X	0	0	0	0	0
塑料	0	0	0	0	0	0
焊接	X	0	0	0	0	0
铜合金/黄铜	X	0	0	0	0	0
本表格依据 SJ/T 11364 的规定编制。						
0：表示该有害物质在该部件所有均质材料中的含量均在 GB/T 26572 规定的限量要求以下。						
X：表示该有害物质至少在该部件的某一均质材料中的含量超出 GB/T 26572 规定的限量要求。						
铅是欧洲RoHS指令2011/65/ EU附件三和附件四目前由于允许的豁免。						

CHINA RoHS COMPLIANCE

Component Name	Hazardous Substances					
	Lead (Pb)	Mercury (Hg)	Cadmium (Cd)	Chromium VI Compounds (Cr(VI))	Polybrominated Biphenyls (PBB)	Polybrominated Diphenyl Ethers (PBDE)
Housing	O	O	O	O	O	O
PCB Board	X	O	O	O	O	O
Electrical Connectors	O	O	O	O	O	O
Piezoelectric Crystals	X	O	O	O	O	O
Epoxy	O	O	O	O	O	O
Teflon	O	O	O	O	O	O
Electronics	O	O	O	O	O	O
Thick Film Substrate	O	O	X	O	O	O
Wires	O	O	O	O	O	O
Cables	X	O	O	O	O	O
Plastic	O	O	O	O	O	O
Solder	X	O	O	O	O	O
Copper Alloy/Brass	X	O	O	O	O	O

This table is prepared in accordance with the provisions of SJ/T 11364.

O: Indicates that said hazardous substance contained in all of the homogeneous materials for this part is below the limit requirement of GB/T 26572.

X: Indicates that said hazardous substance contained in at least one of the homogeneous materials for this part is above the limit requirement of GB/T 26572.

Lead is present due to allowed exemption in Annex III or Annex IV of the European RoHS Directive 2011/65/EU.

1.0 INTRODUCTION

ICP® force sensors incorporate a built-in MOSFET microelectronic amplifier. This serves to convert the high impedance charge output into a low impedance voltage signal for analysis or recording. ICP® sensors, are powered from a separate constant current source, operate over long ordinary coaxial or ribbon cable without signal degradation. The low impedance voltage signal is not affected by triboelectric cable noise or environmental contaminants.

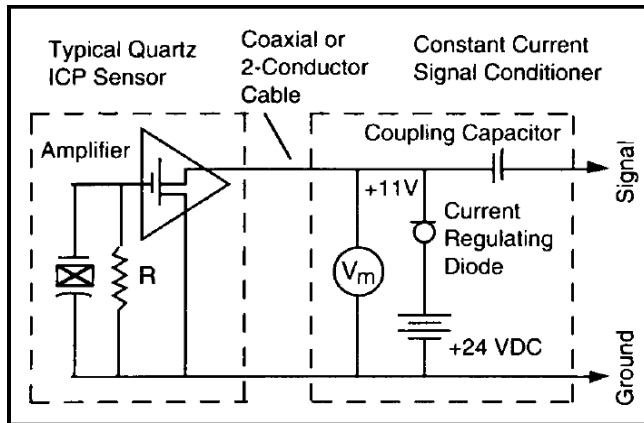

Figure 1 - ICP® Sensor System Schematic

Power to operate ICP® sensors is generally in the form of a low cost, 24-27 VDC, 2-20 mA constant current supply. **Figure 1** schematically illustrates a typical ICP® sensor system. PCB offers a number of AC or battery-powered, single or multi-channel power/signal conditioners, with or without gain capabilities for use with force sensors. In addition, many data acquisition systems now incorporate constant current power for directly powering ICP® sensors. Because static calibration or quasi-static short-term response lasting up to a few seconds is often required, PCB manufactures signal conditioners that provide DC coupling. **Figure 2** summarizes a complete 2-wire ICP® system configuration.

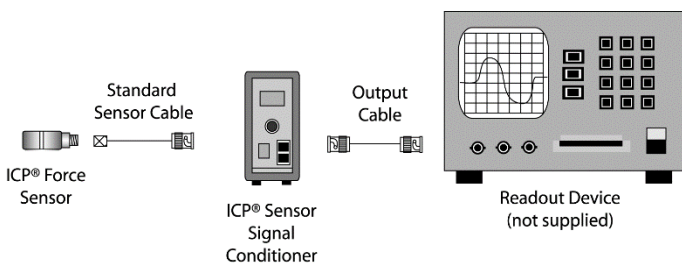

Figure 2 Typical ICP® Sensor System

In addition to ease of operation, ICP® force sensors offer significant advantages over charge mode types. Because of the low impedance output and solid-state, hermetic construction, ICP® force sensors are well suited for continuous, unattended force monitoring in harsh factory environments. Also, ICP® sensor cost-per-channel is substantially lower, since they

operate through standard, low-cost coaxial cable, and do not require expensive charge amplifiers.

Refer to the installation/outline drawing and specification sheet at the back of this manual for details and dimensions of the particular sensor model number(s) purchased. The following pages give a brief description of the various sensor series available, recommended mounting procedures, operation and recommended calibration.

In addition to PCB's line of ICP® sensors, each ICP® sensor series outlined has corresponding charge output versions. Charge mode versions with high output impedance are suited for higher temperature, metal-to-metal and very high shock applications. These models can also be used for applications where it is desirable to manually set the output range.

In addition to standard products, PCB has the ability to design and manufacture custom sensors/systems for specific applications.

If questions arise regarding the operation or characteristics of the force sensor products as outlined in this manual, feel free to contact an experienced PCB applications engineer toll-free at 1-800-828-8840.

2.0 DESCRIPTION

IMPACT

Series 200 Impact Sensors are designed to measure compression and impact forces from a fraction of a lb(N) to 50,000 lbs (to 22.4 kN). The flat sensing surface located on the top of the sensor is designed to measure a dynamic force quickly applied axially to the sensor.

As highlighted in **Figure 3** compression forces directed against the sensing surface produce a positive-going output. A tensile output could be obtained if a static, steady-state load were applied to the sensor. The maximum tensile output to be measured would be that of the applied static, steady state load as that load is quickly removed.

This force-directed input and corresponding output will provide a positive going output signal in ICP® models and a negative going output in charge mode sensors. If desired, adding the prefix "N" to a model number upon order, sometimes desired for charge mode models, will indicate polarity reversal.



Free Standing
Impact Installation

Figure 3 - Series 200 ICP® Impact Sensor

Polyimide film tape covers the cap surface to reduce high frequency ringing associated with metal-to-metal impacts. Internal mounting holes with uniform 10-32 threads are prepared on each end of the sensor in the smaller models. Two Model 081B05-mounting studs (M081B05 for metric installation) are supplied. Larger ICP® Models 200C20 and 200C50, as well as charge mode model 210B50, have 1/4-28 mounting provisions and are supplied with 1/4-28 stud both ends as well as a 1/4-28 to M6x1.0 for metric mounting.

Versions offering full-scale measurement ranges of 10 lb to 5000 lb compression (45 to 22kN) tension are available. For higher ranges, consider the dedicated ring, link, or impact style sensor configurations.

Applications include drop testing, machinery studies, punching and forming operations, tensile testing, fatigue testing, fracture analysis, and materials testing.

RINGS

Series 201B to 207C Ring Sensors are designed to measure compression forces from a fraction of a lb(N) to 100,000 lbs (to 444.8k N).

Each sensor is provided with a calibration certificate reflecting the sensitivity of the sensor when calibrated with a PCB supplied Beryllium Copper (BeCu) mounting stud. In the event a customer is going to install the sensor in a fixture without a mounting stud or with a stud of a stiffer material than the supplied BeCu stud, the sensor sensitivity will be slightly different.

Refer to **Section 3** for recommended force ring mounting and preload requirements.

Figure 4 outlines some possible mounting configurations to which the ring series may be installed



Figure 4 - Series 201 to 207 ICP® Ring Force Sensor
Possible Installation Methods

GENERAL PURPOSE - RADIAL

Model 208C01-C05 General Purpose Sensors are designed to measure compression and impact forces from a fraction of a lb(N) to 5,000 lbs (to 22.24 kN). Tension forces can be measured to 500 lbs (2.224 kN). Model 084A03, a supplied convex, stainless steel cap with integral 10-32 mounting stud, converts this tension/compression model to a sensor capable of impact measurements. Polyimide film tape covers the cap surface to reduce high frequency ringing associated with metal-to-metal impacts.

GENERAL PURPOSE - AXIAL

Models 208A11-A15 Axial Sensors provide performance and specifications similar to the Model 208C Sensors. These sensors are designed primarily to measure compression and impact forces from a few pounds(N) to 5,000 lbs (to 22.24 kN). Tensile forces can be measured to 500 lbs (2.224 kN). The 10-32 axial electrical connector orientation associated with these sensors makes them ideal for installations where radial space is restricted or where physical connector damage may occur due to the nature of the specific application. The M7 x 0.75-6g mounting threads (all models) may be installed directly into a test structure so that the 10-32 electrical connector exits from the opposite side of the mounting fixture. This helps prevent potential damage during drop test applications. This version also uses the Model 084A03 cap for impact measurements.

Figure 5 outlines some possible mounting configurations to which the ring series may be installed



Figure 5 - Series 208 General Purpose and Axial Connector ICP® Force Sensor Installation Methods

LINKS

Series 221B to 227C ICP® Link Sensors are designed for measuring compression from a few pounds(N) to 50,000 lbs (to 222.4 kN), and tension forces from a few pounds (N) to 30,000 lbs (to 133.4 kN). A link consists of a standard PCB ring sensor preloaded between two hex end nuts. All hex nuts are internally threaded for mounting ease to a customer test structure. Unlike ring design sensors, additional external preloading is not required as the factory installed external mounting hardware places the sensor in a preloaded state.

The hex nuts do not loosen naturally. **DO NOT ADJUST THE NUTS WITH A WRENCH.** Loosening or tightening of the hex nuts will change the preload applied to the sensor. The result is that the sensor output will no longer match the factory supplied calibration certificate. In the unlikely event the mounting hardware becomes loose, contact PCB's service and repair document for proper instructions for returning the sensor to PCB for recalibration..

Figure 6 outlines some possible mounting configurations of the link series of sensors.



Figure 6 – Series 221 to 227 ICP® Force Link Sensor Mounting Method

3- COMPONENT TRIAX SENSORS

PCB's line of 3-Component force sensors is capable of simultaneously measuring force in three (3) orthogonal directions (X, Y, and Z). Internally, three sets of quartz crystals are cut, oriented and preloaded so the maximum output from the crystal cut for the specific plane is obtained when a force is applied axially to the specific x, y or z plane. Sensor output from loads applied in the alternate, transverse planes(considered channel cross-talk) is negligible as the crystal sets are cut for maximum output in a specific plane.

Optimum performance and linear operation of 3-component force sensors is obtained when a preload is applied to the sensor. Versions are available with ranges up to 10K lb (45kN) in the Z-axis (perpendicular to the top surface), and up to 4,000 lbs (18kN) in the X and Y (shear) axes.

There are two modes of triaxial force sensors. **ICP®** triaxial designs utilize built-in microelectronic circuitry that provides a low-impedance voltage, the electrical output of which is passed to external signal conditioning via one multi-pin connector mounted on the sensor housing. This design mechanically has one 4-pin electrical connector that may be coupled to a single multi-conductor sensor cable.

High impedance charge mode models contain three (3) separate electrical output connectors on the sensor housing, each corresponding to the respective x, y, or z axis. Low noise cables should be used in low impedance system arrangements. These models are ideal for use in harsh industrial or high temperature environments.

Figure 7 outlines installation possibilities of triax force sensors.

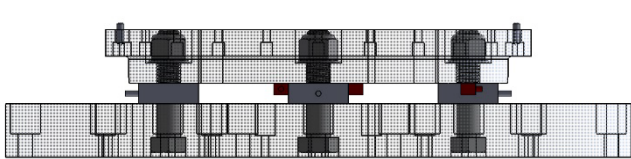

Figure 7 - Series 260 Mounting 3-Component Force Sensor

3-COMPONENT LINK TRIAX SENSORS

Series 261 3-component force sensors are designed for measuring z-axis compression loads from a fraction of a pound(N) to 10,000 lbs (to 45 kN), and x and y-axis radial forces from a few pounds (N) to 4,000 lbs (to 18 kN). These sensors are designed to simultaneously monitor three measurements in the x, y, and z-planes. Similar to the piezoelectric link series, this series consists of a triaxial force sensor factory installed and preloaded between mounting hardware. Additional customer applied preload during installation is not required.

The mounting hardware does not loosen naturally. **DO NOT ADJUST THE MOUNTING HARDWARE** as loosening or tightening of the hardware will change the preload applied to the sensor. Changes to the preload result in changes the factory supplied calibration. In the unlikely event the mounting hardware becomes loose, contact PCB’s service and

repair document for proper instructions for returning the sensor to PCB for recalibration.

Figure 8 – SERIES 3-COMPONENT TRIAX FORCE SENSORS

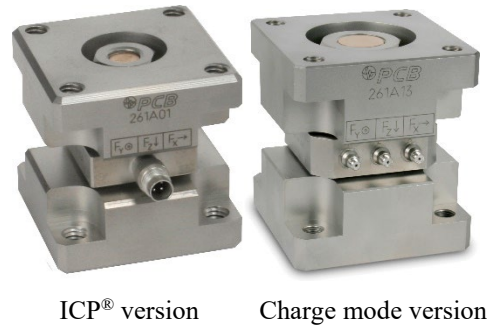

PENETRATION

Penetration style sensors are similar to the axial models but are specifically designed for compression and impact force measurements in materials testing applications. Smooth, cylindrical housings and curved impact caps avoid cutting through specimens. This enables measurements to be taken to determine yield, deformation, and break point measurements of polymers, composites, and other materials. The axial connector configuration installs into force thruster apparatus and protects the connector from potential damage. Versions offering full-scale measurements to 5,000 lb (to 22.24kN) are available. Tension measurements are possible with units having removable caps.



Figure 9 - Series 208A20 ICP® Penetration Force Sensor

MINIATURE/HIGH SENSITIVITY

Series 209 Miniature Sensitivity Sensors permit low amplitude, dynamic compression, tension, and impact force measurements. A full-scale measurement range to 2.2 lbs (9.79 N) compression and to 1 lb (to 4.45 N) tension is standard. Two configurations are available, one with a tapped mounting hole and impact cap, and the other with tapped holes on both ends of

the sensor. Link, integrated link, and freestanding installations are possible as outlined in Figure 9.

Caution – Bending moment concerns

In this model, axial application of forces is critical during measurements due to the sensitivity to bending moments. This sensor series has a very high output (2200mV/lb, 500mV/N) so care should be taken that applied forces are axial to prevent unwanted output (noise) due to bending moments. In addition, the “hat” applied to certain models enabling direct tensile measurements is very small. Axial loads or excessive masses applied to this “hat” could cause it to break away from the main sensor body.

Due to its highly sensitive characteristic, Series 209 sensors may be susceptible to thermal drift caused by temperature transients. These sensors are recommended for use in temperature stable environments only.

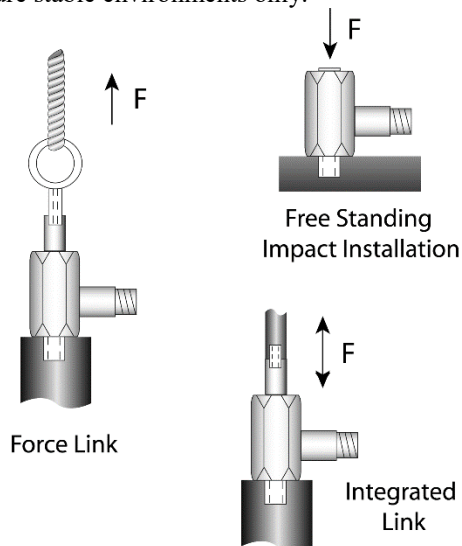

Figure 10 - Series 209 Miniature/High Sensitivity ICP@Force Sensor

3.0 INSTALLATION

CAUTION!

Please read all instructions before attempting to operate this product.

Damage to built-in amplifier due to incorrect power or misapplication is NOT covered by warranty

Refer to the Installation Drawing supplied with this manual for specific outline dimensions and installation details for your particular model. The specification is also included to provide details of the sensor’s characteristic properties.

It is important that the surface to which each sensor is mounted be perfectly flat to avoid flexing of the base, which could affect

sensor sensitivity and result in erroneous data (see **Figure 11**). A good mating surface may be obtained by lapping, turning, spot-facing, or surface grinding. Surface flatness should be held to within 0.001 (TIR) over the entire mating surface. When mounting sensors between two plates care should be taken to assure mounting surfaces are flat and parallel. Non-parallel surfaces could place unwanted stress on internal components leading to premature sensor failure. The protective cap should remain on the electrical connector during installation to prevent connector contamination or damage.

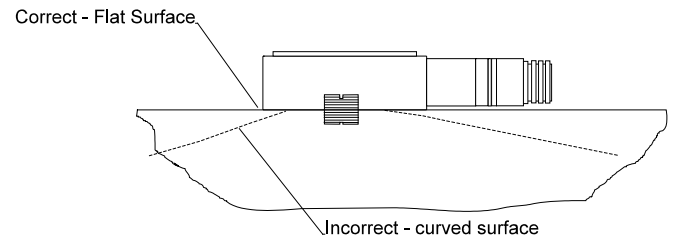

Figure 11 - Force Sensor Installation

A light coating of silicon grease (DC-4 or equivalent) on the mating surface enhances the coupling between the mounting base and mounting surface and provides the best high-frequency response.

Connect one end of the coaxial cable to the sensor connector and the other end to the XDCR jack input on the signal conditioner. Make sure to tighten the cable connector to the sensor. **DO NOT** spin the sensor onto the cable, as this fatigues the cable’s center pin, resulting in a signal with a shorted output or intermittent signal and a damaged cable.

For installation in dirty, humid, or rugged environments, it is suggested that the electrical connection be shielded against dust or moisture with shrink tubing or other protective material. Strain relieving the cable/sensor connection can also prolong cable life. Mounting cables to a test structure with tape, clamps, or adhesives minimizes cable whip. See **Figure 12** for an example of a sensor installation with a securely fastened cable.



Figure 12 - Cable Strain Relief**FORCE RING INSTALLATION**

The sensor is mounted using the supplied mounting stud and pilot bushing. The supplied beryllium copper (BeCu) stud is elastic so it allows force transmission to the sensor while holding the sensor in place. The pilot bushing centers the sensor about the mounting stud. After installing the mounting stud in the lower of the two surfaces, the pilot bushing is threaded over the mounting stud. The sensor is then placed over the stud and pilot bushing combination. The pilot bushing should fit loosely inside of the sensor inner diameter, holding it in place. Properly machined holes for the mounting stud will ensure proper vertical orientation of the sensor. The upper surface should be installed and tightened onto the mounting stud. Refer to the installation drawing for additional mounting details.

When installing the sensor as an integrated member, it is recommended that the supplied antifriction washers be used to eliminate the possibility of damage to the sensing surface of the sensor. This type of damage may occur when imperfections in the mounting surface grind against the sensor surface while the mounting surfaces are being twisted during installation. Refer to the installation drawing for additional mounting details.

PRELOAD REQUIREMENTS FOR FORCE RING AND 3-COMPONENT FORCE SENSORS

PCB ICP® Force Rings (Models 201B01 through 207C) and 3-Component Force Sensors (Models 260A01 through A03) are generally installed between two parts of a test structure, as shown in **Figure 4**. During installation, the sensor should be pre-loaded to the amount specified on the specification sheet using the supplied elastic beryllium-copper stud. Preloading in this arrangement ensures that the sensor will perform as calibrated and have good output linearity at the sensor's lower operating range. Use of a mounting stud of stiffer material or no stud will alter PCB calibrated sensitivity.

The stud or bolt holds the structure together and applies preload to the force ring as shown in **Figure 13**. In the typical link installation, shown on the left in **Figure 13**, part of the force between the two structures is shunted through the mounting stud. The amount of force shunted is dependent on the stud material, but may be up to 5% of the total force for the beryllium-copper stud supplied with the sensor and up to 50% for steel studs. This typical installation setup is used by PCB during standard calibrations of force ring models 201B01 through 207C. PCB's standard calibration, when using the BeCu stud, takes this shunted force into account with the final calibration value.

A non-typical installation is shown on the right side of **Figure 13**. In this installation, the stud or bolt used to apply the preload does not shunt part of the applied force. The plate on top of the sensor has a clearance hole that the stud or bolt passes through. In this installation, the stud or bolt is not directly connected to the top plate by its threads, as it is in the typical installation, so it does not shunt any force. This method of installation accommodates mounting a group of sensors under a common plate.

NOTE: *If any of the following conditions apply to the preloading of the force ring in the actual application, the sensitivity and linearity performance of the sensor will not match the standard PCB calibration values.*

1. *Use of a stud or bolt other than the supplied beryllium-copper stud.*
2. *Use of no stud or bolt.*
3. *Use of an amount of preload other than the recommended amount.*
4. *Use of installation that is different from PCB setup during calibration.*
5. *On rare occasions, a ring sensor may be installed WITHOUT a mounting stud (as installed in precise fixture). In these cases, the sensor sensitivity will be HIGHER than that shown on the PCB calibration certificate.*

In these cases, please contact a PCB applications engineer at 800-828-8840 of the intended installation to discuss your special calibration requirements. PCB can calibrate the sensor without a stud OR ask that a customer supplied mounting stud be provided for use in PCB's calibration process.

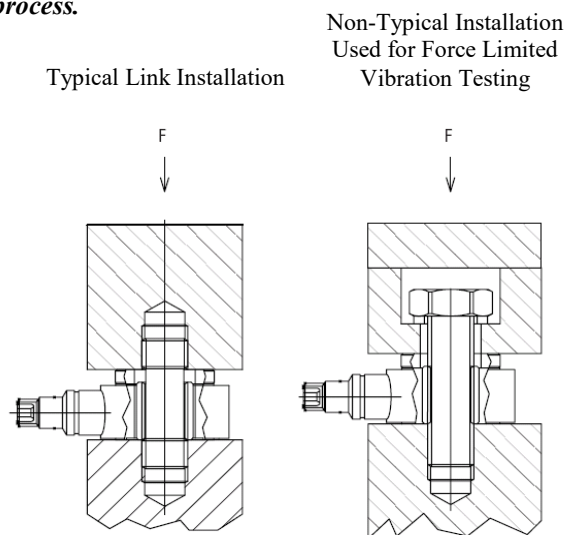
**Figure 13 - Force Ring Sensor Installations**

PCB in-house calibration procedure requires the installation of a force ring with BeCu stud, in the typical installation setup above. This sensor is then placed in series with a NIST

traceable reference sensor. Generally, a preload of 20% (full scale operating range of the force ring) is applied before recording of measurement data. Allow the static component of the signal to discharge before calibration.

3-component force sensors must be preloaded to achieve proper operation, particularly for the shear x-, and y-axis. This preload provides the sensing crystals with the compressive loading required to achieve an output in response to shear direction input forces. The recommended applied preload in the z-axis for 3-component force sensors is 10 times the desired measurement range in the x or y-axis. This higher level z-axis preload is required as the resultant output in the x and y axis is a result of friction generated on the internal crystals specifically cut to provide output in the x or y axis.

As an example, to maximize the sensors output in all three (3ea) axis of a 1000 lb (4500 N) triax load cell, a preload of 5000 lbs (22K) should be applied. This will enable measurements in the x and y axis to be 500 lbs (2225 N).

Please refer to the specific model specifications for the recommended preload. A preload chart in Figure 14 is also provided for quick reference.

As with force rings, the sensitivity achieved from a 3-component force sensor is dependent upon the applied preload and the elasticity characteristics of the mounting bolt or stud used. If the unit is to be installed with a stud or bolt other than the supplied elastic, beryllium copper stud, a calibration using the actual mounting hardware is recommended to be performed. Errors in sensitivity of up to 50% can result by utilizing studs or bolts of different materials.

When installing ICP® ring and 3-component type sensors, a PCB signal conditioner with at least one channel of DC coupling capability is recommended to properly monitor sensor output voltage as it corresponds to the desired preload. A DC-coupled signal conditioner will provide a longer system discharge time constant, which will result in slower signal decay. When used with a DVM or similar readout device, the installer can monitor the sensor output voltage directly for correct preloading.

Monitor the output from the Z-axis connector when preloading 3-component type sensors. These sensors require a preload in the Z-axis that is 10 times their shear range. Some models require this to be accomplished in steps, not to exceed the usable voltage. To prevent “clipping” of the signal, increments should not exceed 10 VDC.

Force Ring Models	Preload (lbf)	Incremental Steps	Sensitivity (mV/lbf)	Step Increment (mV)
201B01	60	3	500	10,000
201B02	100	1	50	5,000
201B03	200	1	10	2,000
201B04	400	1	5	2,000
201B05	1,000	1	1	1,000
202B	2,000	1	0.5	1,000
203B	4,000	1	0.25	1,000
204C	8,000	1	0.12	960
205C	12,000	1	0.08	960
206C	16,000	1	0.06	960
207C	33,750	1	0.05	1,688
3-Component Models				
260A01	5,000	2	2.5	6,250
260A02	10,000	3	2.5	8,333
260A03	40,000	1	0.25	10,000

Figure 14 - ICP® Force Sensor Preload Requirements

WORKING RANGE, PRELOAD, AND MAXIMUM LOAD RELATIONSHIP IN RING STYLE and Triaxial FORCE SENSORS

The **Working Range** is the ideal dynamic working load that may be applied to a sensor during operation. In most sensors, the product of the working range and the sensor sensitivity will provide a 5 Volt output, following the equation;
 $5\text{Volts} = \text{range} \times \text{sensitivity}$.

The **Sensor Preload** is the load applied to the sensor before the sensor is used in an operation. In ring and triax models, preload is essential to match PCB’s calibrated sensitivity as well it assure sensor linearity at the lower measurement range.

The **Maximum Load** is the dynamic load that may be applied before the sensor approaches physical damage. In some sensors this value is a result of a mechanical limitation. In ICP® models this may be an electrical limitation (applying an excessive load under sudden dynamic condition outside the specified range may damage the internal electronic circuitry).

With most sensors, the specified dynamic working range and maximum compression is riding ON TOP OF the applied preload. As an example, triax force sensor Model 260A01 has a specified preload of 5000 lbs (22kN), a working range of 1000 lb (4500N), and a maximum compression range of 1320 lbs (6000 N). To provide the best linear response of the sensor, a 5000 lbs (22kN) preload should be loaded on it. From there one may take dynamic measurements through the entire 1000 lb (4500N) working range of the sensor. Dynamically one should not take measurements above 1320 lbs (6000) as this total load value approaches physical damage to the sensor.

5.0 OPERATION

APPLICATION OF A FORCE

For best results, the applied force should be distributed evenly over the contact surface of the sensor. Care should be taken to limit the bending moment induced into the sensor by edge loading or off-axis loading of the sensor. This is accomplished by applying a force to the sensor as close as possible to the center of the sensor. In the event sensor is to be installed to measure a unit under test with a much larger area than that of the sensing surface of sensor, such as a large metal plate, it may be necessary to use an arrangement of two to four sensors in a measuring platform. Independent sensor output can be monitored or the sensors can be connected electrically in parallel to measure the resulting summed forces when used in a multiple sensor type arrangement.

TYPICAL ICP® SYSTEM CONFIGURATION

Sensors with built-in ICP® circuitry require a constant-current excitation voltage for operation. The enclosed specification sheet provides specific power requirements. Required supply voltage is normally 20 to 30 VDC, while the constant current required ranges from 2 to 20 mA.

PCB standard battery-powered signal conditioners are factory set at 2 mA and may be used to adequately drive a 5.5 kHz signal using a typical PCB 29 pF/ft. cable to a desired 5-Volt full scale output, or about 175 feet (53 meters). PCB line signal supplies are factory set at 4 mA (and adjustable from 2 to 20 mA), enabling signals to be transmitted over hundreds of feet (meters), depending on the frequency of interest.

It is necessary to supply the sensor with a 2 to 20 mA constant current at +20 to +30 VDC through a current-regulating diode or equivalent circuit, contained in all PCB signal conditioners. See Guide G-0001B for powering and signal conditioning information pertaining to all ICP® instrumentation.

Most of the line powered signal conditioners manufactured by PCB have an adjustable current feature allowing a choice of input currents from 2 to 20 mA. In general, for lowest noise (best resolution), choose the lower current ranges. When driving long cables (to several thousand feet(meters)), use higher current, up to 20 mA maximum. Consult a factory applications engineer or local distributor to determine if higher current settings are required.

For sensor operation, connect the sensor to the signal conditioner as shown in the typical ICP® sensor systems below. Complete system operation requires the connection of the force sensor to a signal conditioner, then to a readout device (oscilloscope, meter, recorder, or A-to-D board) or to a readout device with built-in ICP® sensor excitation. Insert the cable center pin into the sensor electrical receptacle. Tighten the coaxial cable to the sensor by turning the cable nut by hand to ensure good electrical contact. **Do not spin the sensor onto**

the cable as this will fatigue the electrical center pin resulting in an intermittent connector or damaged cable.



Figure 15 - Typical ICP® System Configurations

6.0 POLARITY

Compressive forces upon an ICP® force sensor produce a positive-going voltage output. Tensile forces produce a negative-going voltage output. Sensors with reversed polarity are available upon request.

7.0 LOW-FREQUENCY MONITORING

Force sensors used for applications in short term, steady state monitoring, such as sensor calibration, or short term, quasi-static testing should be powered by signal conditioners that operate in DC-coupled mode. PCB Series 482 and 484 Signal Conditioner operates in either AC or DC-coupled mode and may be supplied with gain features or a zero “clamped” output often necessary in repetitive, positive polarity pulse train applications.

If you wish to learn more about ICP® sensors, consult PCB’s General Signal Conditioning Guide, a brochure outlining the technical specifics associated with piezoelectric sensors. This brochure is available from PCB’s website at: http://www.pcb.com/techsupport/tech_signal or from PCB by request, free of charge.

8.0 DISCHARGE TIME CONSTANT

The discharge time constant (DTC) of the entire transduction system from sensor to readout must be considered when attempting to calibrate an ICP force sensor by static methods. In order to take full advantage of the long DTC built into the force sensor, it is best to DC couple from the sensor to the readout device. Several dual-mode PCB signal conditioners (e.g., Series 484) use direct coupling techniques to decouple the output signal from the sensor bias voltage. With the output of the signal conditioner coupled to a DC readout, such as a digital voltmeter (DVM) or oscilloscope, the time constant of the sensor is not compromised by AC coupling elsewhere within the system.

When DC coupling is required to maximize a sensor’s DTC in low frequency applications, it is important to DC couple the entire system, not just from the sensor to the signal conditioner. The system time constant is determined by the shortest time constant in the system. For this reason, the readout device as well as the signal conditioner must be DC coupled.



Figure 16 - Characteristic Discharge Time Constant Curve

The discharge time constant represents the decay rate of an input signal. One DTC represents the amount of time taken for the signal to decay to 37% of the initial peak value. As

illustrated in **Figure 16**, this is an exponential decay. Approximately five DTC intervals are needed for a peak signal to naturally decay back to zero.

The rule of thumb for signal discharge, as outlined in **Figure 17**, is this: for the first 10% of the DTC, the signal lost is approximately proportional to the time elapsed.



Figure 17 - Step Function Response

Step Function Response

For example, a sensor with a 500-second DTC loses approximately 1% of its output level the first five seconds (1% of 500) after the application of a steady state force within the measuring range. In this case, the output reading must be taken within five seconds of the force application for 1% accuracy. If it is impossible to avoid AC coupling somewhere in the sensing system, try to keep the coupling DTC at least an order of magnitude longer than the DTC of the force sensor. This avoids compromising the sensor DTC.

9.0 CALIBRATION

A NIST (National Institute of Standards and Technology) traceable calibration graph is supplied with each force sensor certifying its voltage sensitivity (mV/lb). Calibration procedures follow accepted guidelines as recommended by ANSI (American National Standards Institute), ISA (Instrument Society of America), and ISO (International Organization for Standardization). These standards provide the establishment and management of complete calibration systems, thus controlling the accuracy of a sensor’s specifications by controlling measuring and test equipment accuracy. PCB is A2LA accredited for technical competence in the field of calibration, meeting the requirements of ISO/IEC 17025-1999 and ANSI/NCSL 2540-1-1994.

10.0 TROUBLESHOOTING

When a PCB signal conditioner with any of the following indicators are used, turn the power on and observe the voltmeter (or LED's) on the front panel.

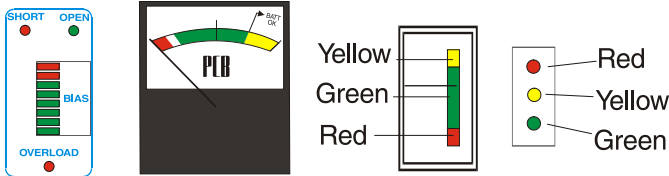

NORMAL OPERATION

INDICATOR	DVM READING	OPERATION
GREEN (Mid-Scale)	8 to 14 V	Proper range for most ICP sensors.
GREEN (Low End)	3 to 7 V	Proper range for low bias ICP sensors.
GREEN (High End)	15 to 17 V	Proper range for high bias ICP sensors.
RED	0 Volts	Short in the sensor, cable, or connections.
YELLOW	24 to 28 V	Open circuit in the sensor, cable, or connections. (Excitation voltage is being monitored.)

Output voltage moves from YELLOW to GREEN slowly until charging is complete. AC coupled signal conditioners require sufficient time to charge the internal coupling capacitor. Allow signal conditioner to charge for five (5) discharge time constants for stable operation. In most cases, this is just a few seconds.

Note: Most PCB force sensors have an output bias of 8-14 VDC. Refer to the specification sheet in this manual for the bias range of the model you are using. If you are using a low bias sensor, the indicator will be at the bottom end of the green portion of the dial indicator, and may even be in the red portion. This is the expected range and indicates proper operation.

11.0 MAINTENANCE

The sensor connector must be kept clean, especially if it is operating in a dusty and/or wet environment. Because the force sensor is of welded construction, it should be returned to the factory for servicing in the event of serious malfunction.

Observe the following precautions in using the sensor:

- A. Do not exceed the maximum load levels for the force sensor (see specification sheet).

- B. Do not subject the sensor to temperatures exceeding that of the specification, normally 250°F (121°C).
- C. Do not apply voltage to the sensor without current-limiting diodes or other current protection.
- D. Do not apply more than 20 mA of current to the force sensor.
- E. When mounting the force sensor, observe installation procedures detailed in Section 3.0 and as outlined on the specific sensor Installation Drawing to avoid over-torquing when mounting.
- F. Do not apply more than 30 volts to the sensor.
- G. *Avoid metal-to-metal impacts* during applications as this application produces high-frequency energy and ringing within the sensor which could damage the internal crystal(s) or ICP amplifier. Electrical low-pass filtering or a mechanical damping material can help reduce such effects.
- H. *Do not spin the sensor onto the cable.* This may fatigue the cable center pin, causing cable damage. Always insert the cable pin into the sensor and tighten the knurled cable nut to the sensor.

ICP® is a registered trademark of PCB Piezotronics

Model Number 208M133	ICP® FORCE SENSOR	Revision: C ECN #: 45224
-------------------------	--------------------------	-----------------------------

Performance	ENGLISH	SI	
Sensitivity(± 10 %)	10 mV/lb	2248 mV/kN	
Measurement Range(Compression)	500 lb	2.224 kN	
Measurement Range(Tension)	500 lb	2.224 kN	
Maximum Static Force(Compression)	5000 lb	22.24 kN	
Maximum Static Force(Tension)	500 lb	2.224 kN	
Broadband Resolution(1 to 10,000 Hz)	0.01 lb-rms	0.0448 N-rms	[1]
Low Frequency Response(-5 %)	0.0003 Hz	0.0003 Hz	[2]
Upper Frequency Limit	36,000 Hz	36,000 Hz	[3]
Non-Linearity	≤ 1 % FS	≤ 1 % FS	[4]
Environmental			
Temperature Range	-65 to +250 °F	-54 to +121 °C	
Temperature Coefficient of Sensitivity	≤ 0.05 %/°F	≤ 0.09 %/°C	
Electrical			
Discharge Time Constant(at room temp)	≥ 2000 sec	≥ 2000 sec	
Excitation Voltage	20 to 30 VDC	20 to 30 VDC	
Constant Current Excitation	2 to 20 mA	2 to 20 mA	
Output Impedance	≤ 100 Ohm	≤ 100 Ohm	
Output Bias Voltage	8 to 14 VDC	8 to 14 VDC	
Spectral Noise(1 Hz)	0.000211 lb/√Hz	0.000942 N/√Hz	[1]
Spectral Noise(10 Hz)	0.000109 lb/√Hz	0.000488 N/√Hz	[1]
Spectral Noise(100 Hz)	0.0000387 lb/√Hz	0.000173 N/√Hz	[1]
Spectral Noise(1000 Hz)	0.0000086 lb/√Hz	0.0000385 N/√Hz	[1]
Output Polarity(Compression)	Positive	Positive	
Physical			
Stiffness	6 lb/μin	1.05 kN/μm	[1]
Size (Diameter x Height)	0.625 in x 0.625 in	15.88 mm x 15.88 mm	
Weight	0.93 oz	26 gm	
Housing Material	Stainless Steel	Stainless Steel	
Sealing	Hermetic	Hermetic	
Electrical Connector	10-32 Coaxial Jack	10-32 Coaxial Jack	
Electrical Connection Position	Side	Side	
Mounting Thread	10-32 Female	10-32 Female	

OPTIONAL VERSIONS

Optional versions have identical specifications and accessories as listed for the standard model except where noted below. More than one option may be used.

NOTES:

[1]Typical.
 [2]Calculated from discharge time constant.
 [3]Estimated using rigid body dynamics calculations.
 [4]Zero-based, least-squares, straight line method.
 [5]See PCB Declaration of Conformance PS023 for details.

SUPPLIED ACCESSORIES:

Model 081B05 Mounting Stud (10-32 to 10-32) (2)
 Model 084A03 Impact Cap (1)

Entered: LK	Engineer: MJK	Sales: KWW	Approved: APB	Spec Number:
Date: 3/29/2016	Date: 3/29/2016	Date: 3/29/2016	Date: 3/29/2016	4630



All specifications are at room temperature unless otherwise specified.
 In the interest of constant product improvement, we reserve the right to change specifications without notice.
 ICP® is a registered trademark of PCB Group, Inc.



Phone: 716-684-0001
 Fax: 716-684-0987
 E-Mail: info@pcb.com

4626

PCB Piezotronics Inc. claims proprietary rights in the information disclosed hereon. Neither it nor any reproduction thereof will be disclosed to others without written consent of PCB Piezotronics Inc.

APPLICATION		
NEXT ASS'Y	USED ON	VAR

REVISIONS				
REV	DESCRIPTION	ECN	DATE	APP'D
A	UPDATED DRAWING	15138	4/1/02	<i>Om4/ll</i>

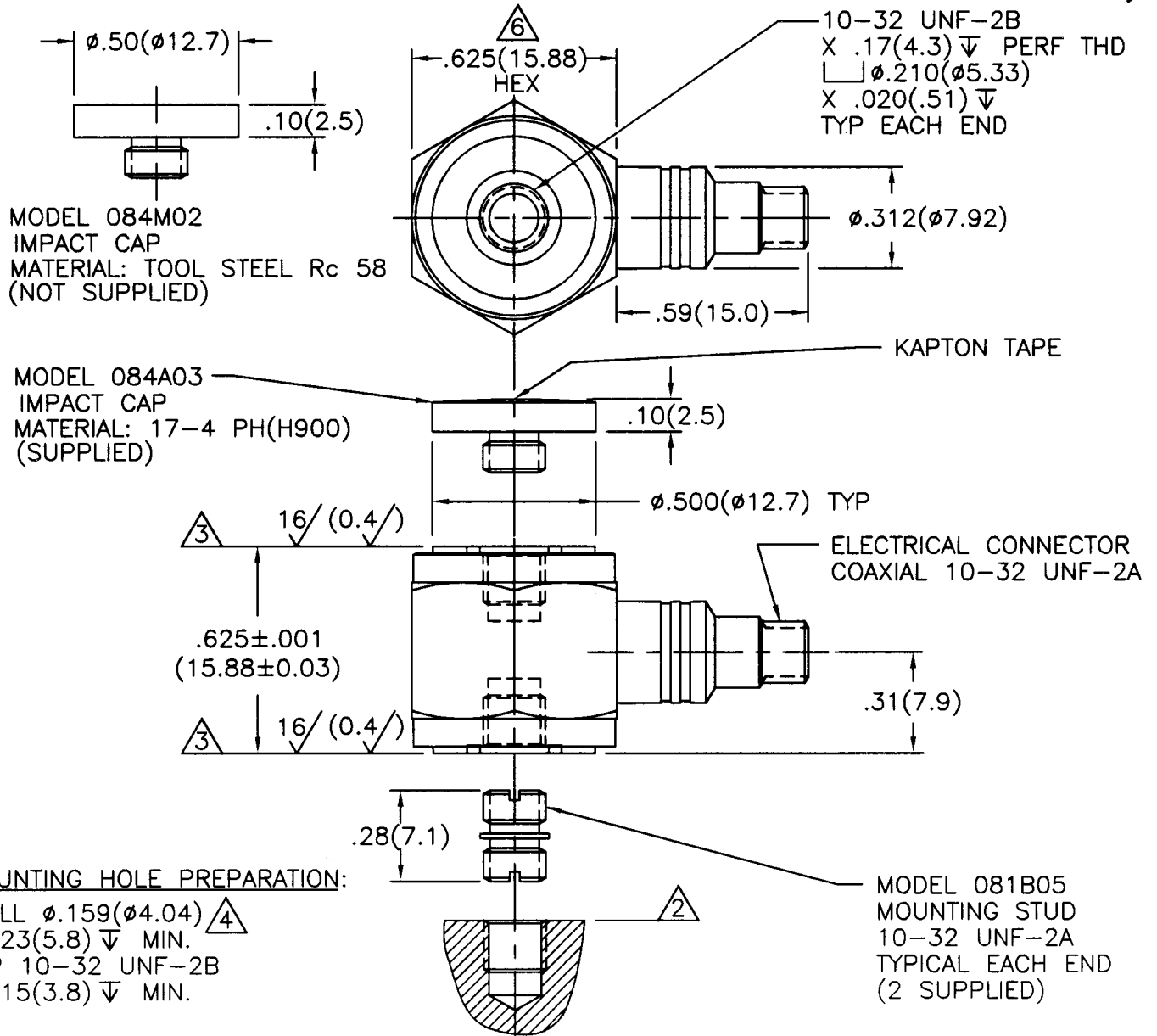

MOUNTING HOLE PREPARATION:

DRILL $\phi .159 (\phi 4.04)$ $\triangle 4$
 X $.23 (5.8)$ ∇ MIN.
 TAP 10-32 UNF-2B
 X $.15 (3.8)$ ∇ MIN.

- $\triangle 6$ MOUNTING TORQUE ON $.625 (15.88)$ HEX, 16-20 INCH POUNDS (181-226 NEWTON CENTIMETERS).
- 5.) COMPRESSIVE FORCE ON CELL YIELDS POSITIVE OUTPUT VOLTAGE.
- $\triangle 4$ DRILL PERPENDICULAR TO MOUNTING SURFACE TO WITHIN $\pm 1^\circ$.
- $\triangle 3$ THESE SURFACES GROUND FLAT AND PARALLEL TO WITHIN $.001 (0.03)$ TIR.
- $\triangle 2$ MOUNTING SURFACE TO BE FLAT TO WITHIN $.001 (0.03)$ TIR WITH A MIN $125 \sqrt{(3.2)}$.
- 1.) CASE MATERIAL-STAINLESS STEEL.

UNLESS SPECIFIED TOLERANCES		DRAWN	JDM	4-2-02	MFG	JRS	4/8/02	 3425 WALDEN AVE. DEPEW, NY 14043 (716) 684-0001 EMAIL: SALES@PCB.COM
DIMENSIONS IN INCHES	DIMENSIONS IN MILLIMETERS (IN PARENTHESIS)	CHK'D	zm	4/15/02	ENGR	z. w. b.	4/10/02	
DECIMALS XX $\pm .01$ XXX $\pm .005$	DECIMALS XX ± 0.3 XXX ± 0.13	APP'D	z. w. b.	4/15/02	SALES	z. w. b.	4/15/02	
ANGLES ± 2 DEGREES	ANGLES ± 2 DEGREES	TITLE	INSTALLATION DRAWING MODEL 208M133 LOAD CELL				CODE IDENT. NO. 52681	
FILLETS AND RADII .003 - .005	FILLETS AND RADII (0.07 - 0.13)							DWG. NO. 4626
DD011 REV. B 03/13/98							SCALE: 2X	SHEET 1 OF 1