



Model 682A02
ICP® Sensor Signal Conditioner
Installation and Operating Manual

**For assistance with the operation of this product,
contact PCB Piezotronics, Inc.**

Toll-free: 800-828-8840
24-hour SensorLine: 716-684-0001
Fax: 716-684-0987
E-mail: info@pcb.com
Web: www.pcb.com



The information contained in this document supersedes all similar information that may be found elsewhere in this manual.

Total Customer Satisfaction – PCB Piezotronics guarantees Total Customer Satisfaction. If, at any time, for any reason, you are not completely satisfied with any PCB product, PCB will repair, replace, or exchange it at no charge. You may also choose to have your purchase price refunded in lieu of the repair, replacement, or exchange of the product.

Service – Due to the sophisticated nature of the sensors and associated instrumentation provided by PCB Piezotronics, user servicing or repair is not recommended and, if attempted, may void the factory warranty. Routine maintenance, such as the cleaning of electrical connectors, housings, and mounting surfaces with solutions and techniques that will not harm the physical material of construction, is acceptable. Caution should be observed to insure that liquids are not permitted to migrate into devices that are not hermetically sealed. Such devices should only be wiped with a dampened cloth and never submerged or have liquids poured upon them.

Repair – In the event that equipment becomes damaged or ceases to operate, arrangements should be made to return the equipment to PCB Piezotronics for repair. User servicing or repair is not recommended and, if attempted, may void the factory warranty.

Calibration – Routine calibration of sensors and associated instrumentation is

recommended as this helps build confidence in measurement accuracy and acquired data. Equipment calibration cycles are typically established by the users own quality regimen. When in doubt about a calibration cycle, a good “rule of thumb” is to recalibrate on an annual basis. It is also good practice to recalibrate after exposure to any severe temperature extreme, shock, load, or other environmental influence, or prior to any critical test.

PCB Piezotronics maintains an ISO-9001 certified metrology laboratory and offers calibration services, which are accredited by A2LA to ISO/IEC 17025, with full traceability to N.I.S.T. In addition to the normally supplied calibration, special testing is also available, such as: sensitivity at elevated or cryogenic temperatures, phase response, extended high or low frequency response, extended range, leak testing, hydrostatic pressure testing, and others. For information on standard recalibration services or special testing, contact your local PCB Piezotronics distributor, sales representative, or factory customer service representative.

Returning Equipment – *Following these procedures will insure that your returned materials are handled in the most expedient manner.* Before returning any equipment to PCB Piezotronics, contact your local distributor, sales representative, or factory customer service representative to obtain a Return

Materials Authorization (RMA) Number. This RMA number should be clearly marked on the outside of all package(s) and on the packing list(s) accompanying the shipment. A detailed account of the nature of the problem(s) being experienced with the equipment should also be included inside the package(s) containing any returned materials.

A Purchase Order, included with the returned materials, will expedite the turn-around of serviced equipment. It is recommended to include authorization on the Purchase Order for PCB to proceed with any repairs, as long as they do not exceed 50% of the replacement cost of the returned item(s). PCB will provide a price quotation or replacement recommendation for any item whose repair costs would exceed 50% of replacement cost, or any item that is not economically feasible to repair. For routine calibration services, the Purchase Order should include authorization to proceed and return at current pricing, which can be obtained from a factory customer service representative.

Warranty – All equipment and repair services provided by PCB Piezotronics, Inc. are covered by a limited warranty against defective material and workmanship for a period of one year from date of original purchase. Contact

PCB for a complete statement of our warranty. Expendable items, such as batteries and mounting hardware, are not covered by warranty. Mechanical damage to equipment due to improper use is not covered by warranty. Electronic circuitry failure caused by the introduction of unregulated or improper excitation power or electrostatic discharge is not covered by warranty.

Contact Information – International customers should direct all inquiries to their local distributor or sales office. A complete list of distributors and offices can be found at www.pcb.com. Customers within the United States may contact their local sales representative or a factory customer service representative. A complete list of sales representatives can be found at www.pcb.com. Toll-free telephone numbers for a factory customer service representative, in the division responsible for this product, can be found on the title page at the front of this manual. Our ship to address and general contact numbers are:

PCB Piezotronics, Inc.
3425 Walden Ave.
Depew, NY 14043 USA
Toll-free: (800) 828-8840
24-hour SensorLineSM: (716) 684-0001
Website: www.pcb.com
E-mail: info@pcb.com

PRODUCT SPECIFIC NOTES

Model 682A02

Description:

The Model 682A02 is a Din-Rail mountable, ICP® signal conditioner. Internally, it has jumpers for selections of gain and current. The gain is selectable between 1, 10, and 100; and the current of 4 or 10 mA is also jumper selectable. The unit is powered externally from a 24 VDC power supply. All connections are easily made using terminal strips on the sides of the unit.

Installation and Operation:

1) Installation:

The unit snaps onto a 35 mm Din Rail for easy installation. Wires are attached by sliding a stripped conductor end into the terminal and securing in place by tightening the appropriate screw with a small screwdriver.

The jumpers can be adjusted by prying open the enclosure and moving the jumpers to the proper position for desired gain and constant current. When opening the unit, be careful not to damage the enclosure or the internal electronics. Refer to Section 3 for proper jumper selection.

2) Wiring, Terminal Strip:

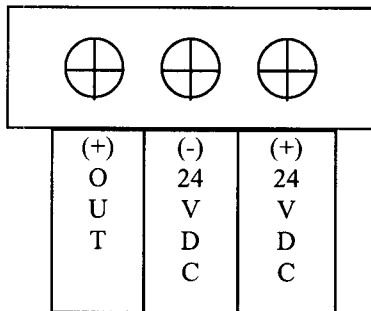

- (+) **OUT:** Sensor Positive Output Signal
- (-) **24 VDC:** Negative 24 Volt Supply
- (+) **24 VDC:** Positive 24 Volt Supply

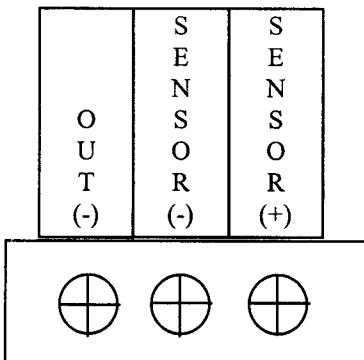

- (-) **Out:** Sensor Negative Output Signal
- (-) **Sensor:** Sensor Negative Input

(+) **Sensor:** Sensor Positive Input

3) Internal Jumper Locations:

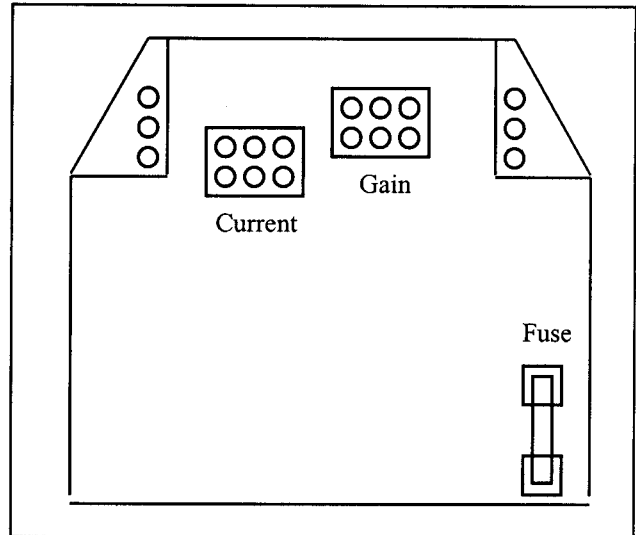
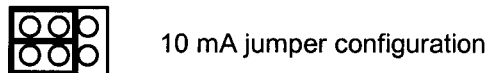
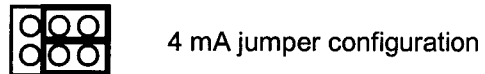

Fig. 1: Top View of Circuit Board

Jumper Configurations:

Current Selection



Gain Selection

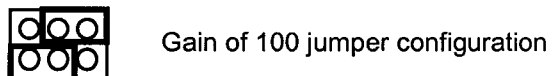
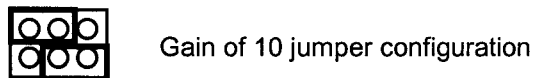
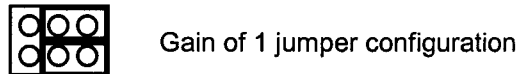

4) Calibration:

Units are factory set with a gain of 1 and a current of 4 mA. If there are any questions concerning the products, please contact the factory.

Model Number 682A02	ICP® SENSOR SIGNAL CONDITIONER			Revision A ECN #: 15998
Performance Channels Voltage Gain Frequency Range (±1 dB) Non-Linearity	ENGLISH 1 1/10/100 60 to 6000000 cpm ≤2 %	SI 1 1/10/100 1 to 100000 Hz ≤2 %		Optional Versions (Optional versions have identical specifications and accessories as listed for standard model except where noted below. More than one option maybe used.)
Environmental Temperature Range	32 to 158 °F	0 to 70 °C		Notes [1] If unit is used in conjunction with a sensor having a bias over 13 VDC, full scale output may be affected or sensor may not power up.
Electrical				[2] Jumper selectable on internal circuit board.
Power Required (Standard)	DC power	DC power		[3] Typical.
Excitation Voltage (±1 VDC) (To Sensor)	18 VDC	18 VDC	[1]	[4] Gain x1
DC Power (±10 %)	24 VDC	24 VDC		[5] Gain x10
DC Power	≤60 mA	≤60 mA		[6] Gain x100
Constant Current Excitation (To Sensor)	4/10 mA	4/10 mA	[2]	[7] 1Hz = 60 cpm (cycles per minute).
Spectral Noise (10 Hz)	0.8 μV/√Hz	0.8 μV/√Hz	[3][4]	Supplied Accessories
Spectral Noise (100 Hz)	0.5 μV/√Hz	0.5 μV/√Hz	[3][4]	017AXX Power Cord ()
Spectral Noise (1 kHz)	0.5 μV/√Hz	0.5 μV/√Hz	[3][4]	488B04/NC Power Convertor ()
Spectral Noise (10 kHz)	0.6 μV/√Hz	0.6 μV/√Hz	[3][4]	
Broadband Electrical Noise (1 to 10 kHz)	50 μV	50 μV	[3][4]	
Spectral Noise (10 Hz)	7.5 μV/√Hz	7.5 μV/√Hz	[3][5]	
Spectral Noise (100 Hz)	3.6 μV/√Hz	3.6 μV/√Hz	[3][5]	
Spectral Noise (1 kHz)	3.2 μV/√Hz	3.2 μV/√Hz	[3][5]	
Spectral Noise (10 kHz)	6.0 μV/√Hz	6.0 μV/√Hz	[3][5]	
Broadband Electrical Noise (1 to 10 kHz)	400 μV	400 μV	[3][5]	
Spectral Noise (10 Hz)	80 μV/√Hz	80 μV/√Hz	[3][6]	
Spectral Noise (100 Hz)	40 μV/√Hz	40 μV/√Hz	[3][6]	
Spectral Noise (1 kHz)	32 μV/√Hz	32 μV/√Hz	[3][6]	
Spectral Noise (10 kHz)	50 μV/√Hz	50 μV/√Hz	[3][6]	
Broadband Electrical Noise (1 to 10 kHz)	3.5 mV	3.5 mV	[3][6]	
Fuse	1 A	1 A		
Physical				
Electrical Connector (ICP® Sensor Input)	Screw Terminals	Screw Terminals		
Electrical Connector (Output)	Screw Terminals	Screw Terminals		
Electrical Connector (DC Power Input)	Screw Terminals	Screw Terminals		
Mounting	DIN Rail	DIN Rail		
Size (Height x Width x Depth)	3.1 in x 0.97 in x 3.3 in	78.7 mm x 24.6 mm x 83.8 mm		
Weight	0.194 lb	0.088 Kg		

Entered: ECB	Engineer: NJF	Sales: JJP	Approved: NJF	Spec Number:
Date: 09/09/2002	Date: 09/09/2002	Date: 09/09/2002	Date: 09/14/2002	9702



3425 Walden Avenue
 Depew, NY 14043
 UNITED STATES
 Phone: 800-828-8840
 Fax: 716-684-0987
 E-mail: info@pcb.com
 Web site: www.pcb.com

All specifications are at room temperature unless otherwise specified.

In the interest of constant product improvement, we reserve the right to change specifications without notice.

9669

PCB Piezotronics Inc. claims proprietary rights in the information disclosed hereon. Neither it nor any reproduction thereof will be disclosed to others without written consent of PCB Piezotronics Inc.

APPLICATION

NEXT ASS'Y	USED ON	VAR

REVISIONS

REV	DESCRIPTION	ECN	DATE	APP'D

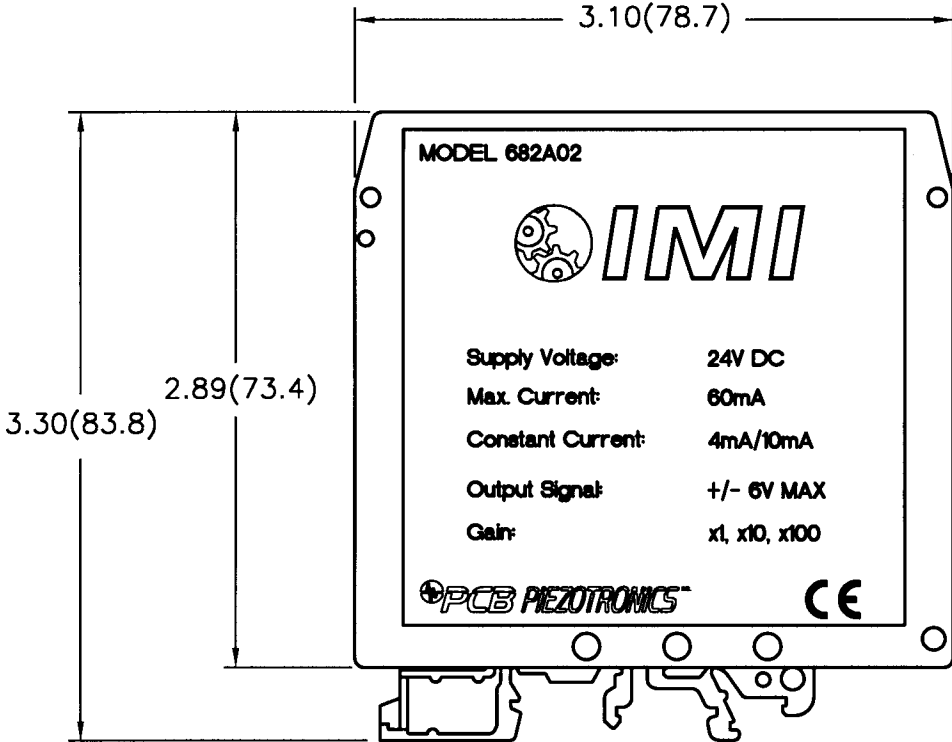
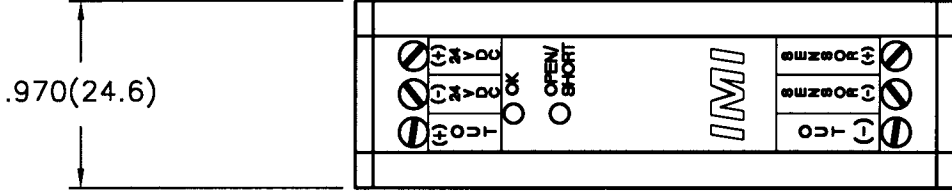

UNLESS SPECIFIED TOLERANCES	
DIMENSIONS IN INCHES	DIMENSIONS IN MILLIMETERS (IN PARENTHESIS)
DECIMALS XX ±.01	DECIMALS XX ±0.3
XXX ±.005	XXX ±0.13
ANGLES ±2 DEGREES	ANGLES ±2 DEGREES
FILLET AND RADII .003 - .005	FILLET AND RADII (0.07 - 0.13)

DRAWN	TW	11/3/98	MFG	R.D	11/4/98
CHK'D	DM	11/5/98	ENGR	TC	11/4/98
APP'D	U.F	11/5/98		BJ	11/4/98
TITLE OUTLINE DRAWING MODEL 682A02 SIGNAL CONDITIONER					

3425 WALDEN AVE. DEPEW, NY 14043 (716) 684-0001 EMAIL: SALES@PCB.COM	
CODE IDENT. NO. 52681	DWG. NO. 9669
SCALE: FULL	SHEET 1 OF 1