



**Model EXTO641B31**

**Intrinsically-safe, dual output (vibration/temperature) vibration sensor, 4 to 20 mA output, 0 to 1.0 in/sec RMS, 10 to 1k Hz, top exit, 4-pin bayonet conn**

**Installation and Operating Manual**

**For assistance with the operation of this product,  
contact the PCB Piezotronics, Inc.**

**Toll-free: 800-959-4464**

**24-hour SensorLine: 716-684-0001**

**Fax: 716-684-3823**

**E-mail: [imi@pcb.com](mailto:imi@pcb.com)**

**Web: [www.imi-sensors.com](http://www.imi-sensors.com)**



## Repair and Maintenance

PCB guarantees Total Customer Satisfaction through its “Lifetime Warranty Plus” on all Platinum Stock Products sold by PCB and through its limited warranties on all other PCB Stock, Standard and Special products. Due to the sophisticated nature of our sensors and associated instrumentation, **field servicing and repair is not recommended and, if attempted, will void the factory warranty.**

Beyond routine calibration and battery replacements where applicable, our products require no user maintenance. Clean electrical connectors, housings, and mounting surfaces with solutions and techniques that will not harm the material of construction. Observe caution when using liquids near devices that are not hermetically sealed. Such devices should only be wiped with a dampened cloth—never saturated or submerged.

In the event that equipment becomes damaged or ceases to operate, our Application Engineers are here to support your troubleshooting efforts 24 hours a day, 7 days a week. Call or email with model and serial number as well as a brief description of the problem.

## Calibration

Routine calibration of sensors and associated instrumentation is necessary to maintain measurement accuracy. We recommend calibrating on an annual basis, after exposure to any extreme environmental influence, or prior to any critical test.

PCB Piezotronics is an ISO-9001 certified company whose calibration services are accredited by A2LA to ISO/IEC 17025, with full traceability to SI through N.I.S.T. In addition to our standard calibration services, we also offer specialized tests, including: sensitivity at elevated or cryogenic temperatures, phase response, extended high or low frequency response, extended range, leak testing, hydrostatic pressure testing, and others. For more information, contact your local PCB Piezotronics distributor, sales representative, or factory customer service representative.

## Returning Equipment

If factory repair is required, our representatives will provide you with a Return Material Authorization (RMA) number, which we use to reference any information you have already provided and expedite the repair process. This number should be clearly marked on the outside of all returned package(s) and on any packing list(s) accompanying the shipment.

## Contact Information

PCB Piezotronics, Inc.  
3425 Walden Ave.  
Depew, NY14043 USA  
Toll-free: (800) 828-8840  
24-hour SensorLine: (716) 684-0001  
General inquiries: [info@pcb.com](mailto:info@pcb.com)  
Repair inquiries: [rma@pcb.com](mailto:rma@pcb.com)

For a complete list of distributors, global offices and sales representatives, visit our website, [www.pcb.com](http://www.pcb.com).

## Safety Considerations

This product is intended for use by qualified personnel who recognize shock hazards and are familiar with the precautions required to avoid injury. While our equipment is designed with user safety in mind, the protection provided by the equipment may be impaired if equipment is used in a manner not specified by this manual.

Discontinue use and contact our 24-Hour Sensorline if:

- Assistance is needed to safely operate equipment
- Damage is visible or suspected
- Equipment fails or malfunctions

For complete equipment ratings, refer to the enclosed specification sheet for your product.

## Definition of Terms and Symbols

The following symbols may be used in this manual:



### **DANGER**

Indicates an immediate hazardous situation, which, if not avoided, may result in death or serious injury.

**CAUTION**

Refers to hazards that could damage the instrument.

**NOTE**

Indicates tips, recommendations and important information. The notes simplify processes and contain additional information on particular operating steps.

**The following symbols may be found on the equipment described in this manual:**



This symbol on the unit indicates that high voltage may be present. Use standard safety precautions to avoid personal contact with this voltage.



This symbol on the unit indicates that the user should refer to the operating instructions located in the manual.



This symbol indicates safety, earth ground.



PCB工业监视和测量设备 - 中国RoHS2公布表

PCB Industrial Monitoring and Measuring Equipment - China RoHS 2 Disclosure Table

部件名称	有害物质					
	铅 (Pb)	汞 (Hg)	镉 (Cd)	六价铬 (Cr(VI))	多溴联苯 (PBB)	多溴二苯醚 (PBDE)
住房	0	0	0	0	0	0
PCB板	X	0	0	0	0	0
电气连接器	0	0	0	0	0	0
压电晶体	X	0	0	0	0	0
环氧	0	0	0	0	0	0
铁氟龙	0	0	0	0	0	0
电子	0	0	0	0	0	0
厚膜基板	0	0	X	0	0	0
电线	0	0	0	0	0	0
电缆	X	0	0	0	0	0
塑料	0	0	0	0	0	0
焊接	X	0	0	0	0	0
铜合金/黄铜	X	0	0	0	0	0
本表格依据 SJ/T 11364 的规定编制。						
0：表示该有害物质在该部件所有均质材料中的含量均在 GB/T 26572 规定的限量要求以下。						
X：表示该有害物质至少在该部件的某一均质材料中的含量超出 GB/T 26572 规定的限量要求。						
铅是欧洲RoHS指令2011/65/ EU附件三和附件四目前由于允许的豁免。						

CHINA RoHS COMPLIANCE

Component Name	Hazardous Substances					
	Lead (Pb)	Mercury (Hg)	Cadmium (Cd)	Chromium VI Compounds (Cr(VI))	Polybrominated Biphenyls (PBB)	Polybrominated Diphenyl Ethers (PBDE)
Housing	O	O	O	O	O	O
PCB Board	X	O	O	O	O	O
Electrical Connectors	O	O	O	O	O	O
Piezoelectric Crystals	X	O	O	O	O	O
Epoxy	O	O	O	O	O	O
Teflon	O	O	O	O	O	O
Electronics	O	O	O	O	O	O
Thick Film Substrate	O	O	X	O	O	O
Wires	O	O	O	O	O	O
Cables	X	O	O	O	O	O
Plastic	O	O	O	O	O	O
Solder	X	O	O	O	O	O
Copper Alloy/Brass	X	O	O	O	O	O

This table is prepared in accordance with the provisions of SJ/T 11364.

O: Indicates that said hazardous substance contained in all of the homogeneous materials for this part is below the limit requirement of GB/T 26572.

X: Indicates that said hazardous substance contained in at least one of the homogeneous materials for this part is above the limit requirement of GB/T 26572.

Lead is present due to allowed exemption in Annex III or Annex IV of the European RoHS Directive 2011/65/EU.

**Model 640/641/645/646 B Series Industrial 4-20mA Sensor**



**Operating Guide with Enclosed Warranty Information**

**3425 Walden Avenue, Depew, New York 14043-2495**

**Phone (716) 684-0003**

**Fax (716) 684-3823**

**Toll Free Line 1-800-959-4IMI**

## **Table of Contents**

---

<i>Introduction.....</i>	<i>Page 3</i>
<i>General Features</i>	
<i>Dimension Drawing .....</i>	<i>Page 4</i>
<i>Operation and Wiring .....</i>	<i>Page 5</i>
<i>Standard Wiring</i>	
<i>Taking Measurements</i>	
<i>RV Option</i>	
<i>RVVO Option</i>	
<i>TO Option</i>	
<i>Installation .....</i>	<i>Page 9</i>
<i>Direct Adhesive Mount</i>	
<i>Standard Stud Mount</i>	
<i>Adhesive Stud Mount</i>	
<i>Magnetic Mount</i>	
<i>ESD Sensitivity.....</i>	<i>Page 13</i>

## **Warranty/Service**

---

<i>Warranty, Service &amp; Return Procedure .....</i>	<i>Page 14</i>
<i>Customer Service.....</i>	<i>Page 15</i>

## **Introduction**

The Model 640/641/645/646 B Series Industrial 4-20mA Sensors combine the capabilities of a piezoelectric vibration sensor and a 4-20mA vibration transmitter. The sensor outputs a 4-20mA signal that is proportional to the overall velocity or acceleration of the machinery. Ideal for monitoring the vibration of process equipment such as fans, motors and pumps, the output of the sensor is used for process control or predictive maintenance. There are many options in this series. Please refer to specific specification sheets for further details.

### **General Features**

- Imbedded Piezoelectric Accelerometer for improved accuracy and frequency response.
- Vibration range can be in Acceleration or Velocity.
- Allows for continuous vibration monitoring of critical applications.
- Reduces sophisticated vibration analysis requirements.
- RV (Raw Vibration) option for conducting frequency analysis and machinery diagnostics.
- RVVO (Raw Vibration Velocity Output) option for conducting freq. analysis and machinery diagnosis.
- TO (Temperature Output) option via an independent 4-20mA loop.
- Readily interfaces to existing process control and predictive maintenance equipment.
- Rugged stainless steel construction for applications in harsh environments.
- Flexible design allows for various custom requirements.



## Dimension Drawing

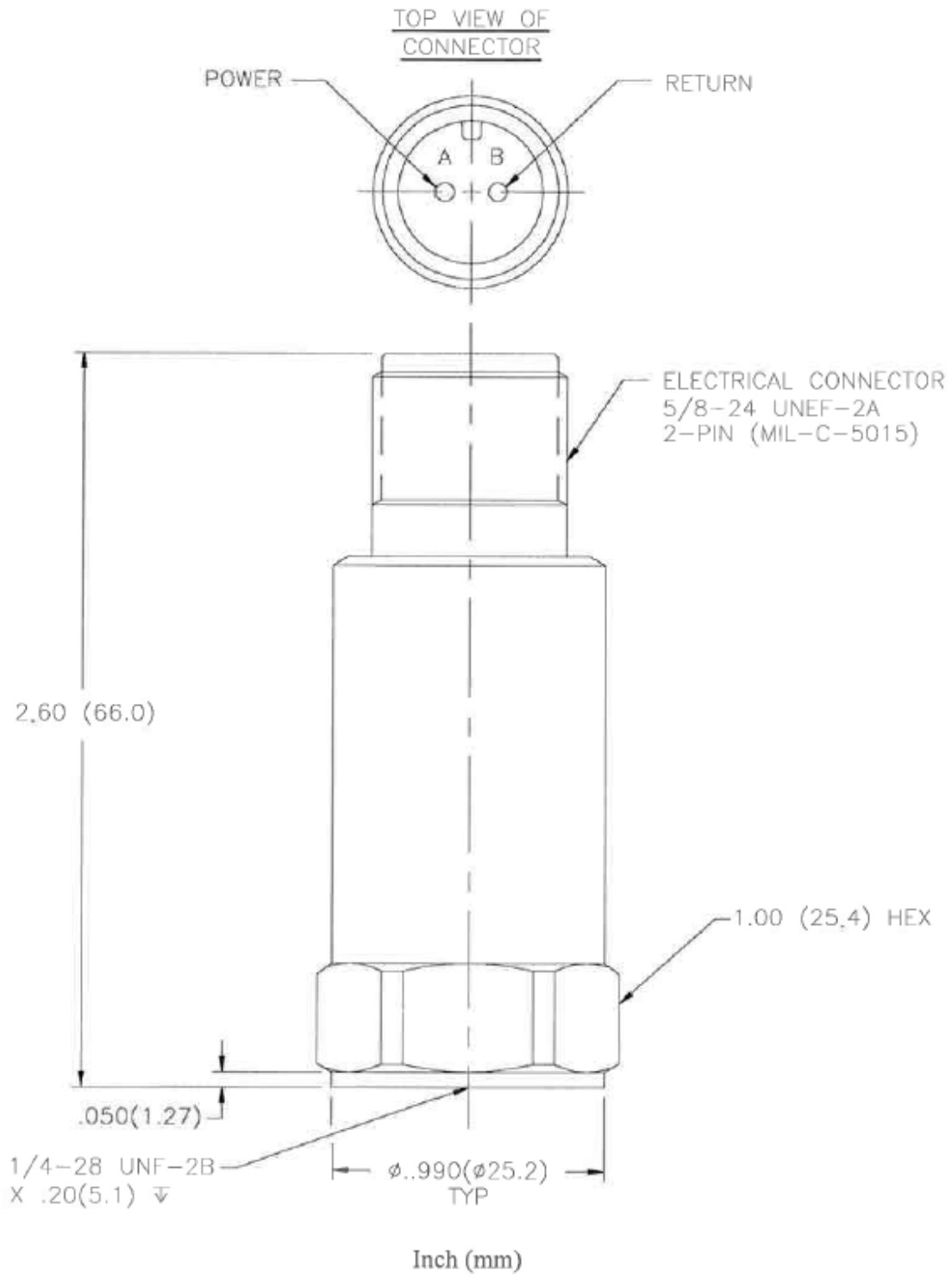

## Operation and Wiring

### Standard Wiring

The Model 640/641/645/646 B Series operates from a standard 2-Wire, 4-20mA loop. If using a loop powered unit, attach the positive (+) input from the power supply to Pin A or **Red** wire on the sensor and the negative (-) input from the power supply to Pin B or **Blue** Wire of the sensor.

*Figure 1 – wiring: loop powered*

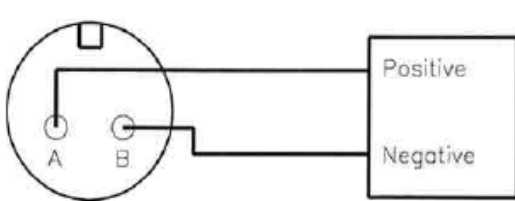

*Figure 2 – wiring: loop powered/DC source*

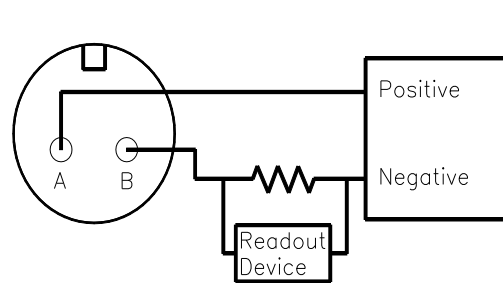

If using a standard DC power supply, install either an ammeter and/or load resistor in line with the output, Pin B or **Blue** Wire.

The resistor will generate a DC voltage that is proportional to current by:

$$V = IR$$

$$\text{If } R = 500 \text{ ohms and } I = 6 \text{ mA, then } V = 3 \text{ VDC}$$

**Note:**

- Resistor value must be less than:  $(V_{\text{supply}} - 12) \times 50$ .
- For integral cable sensors: RED wire is positive, BLUE wire is negative.

### Taking Measurements

When measuring the current output from the unit, use the following formula to calculate the vibration level:

$$\text{Vibration Output} = (\text{Measured Output} - 4\text{mA}) \times (\text{Full Scale Vibration Output} / 16\text{mA})$$

<b>Measured mA</b>	<b>640BX0</b>	<b>640BX1</b>	<b>640BX2</b>
4.00	0.0 ips, pk	0.0 ips, pk	0.0 ips, pk
8.00	0.125 ips, pk	0.25 ips, pk	0.5 ips, pk
12.0	0.25 ips, pk	0.5 ips, pk	1.0 ips, pk
15.75	0.37 ips, pk	0.73 ips, pk	1.47 ips, pk
20	0.5 ips, pk	1.0 ips, pk	2.0 ips, pk

<b>Measured mA</b>	<b>641BX0</b>	<b>641BX1</b>	<b>641BX2</b>
4.00	0.0 ips, rms	0.0 ips, rms	0.0 ips, rms
8.00	0.125 ips, rms	0.25 ips, rms	0.5 ips, rms
12.0	0.25 ips, rms	0.5 ips, rms	1.0 ips, rms
15.75	0.37 ips, rms	0.73 ips, rms	1.47 ips, rms
20	0.5 ips, rms	1.0 ips, rms	2.0 ips, rms

<b>Measured mA</b>	<b>645</b>	<b>646</b>
4.00	0.0 g rms	0.0 g rms
8.00	1.25 g rms	2.50 g rms
12.0	2.50 g rms	5.00 g rms
15.75	3.67 g rms	7.34 g rms
20	5.00 g rms	10.0 g rms

### RV Option

The RV (raw vibration) option includes a 100mV/g  $\pm 20\%$  additional output. The accelerometer frequency range is 1 Hz-1 kHz, maximum amplitude of 15 g-pk. Data collectors or analyzers can use this vibration signal for further analysis. This output is extended to the RVVO (Raw Vibration Velocity Output) option, which integrates the signal to a value of 100 mV/IPS ( $\pm 20\%$ ).

**Figure 3 – RV and RVVO wiring**

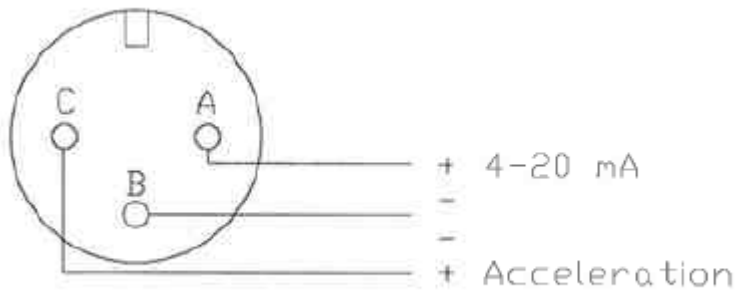

For integral cable sensors:

<b>RED</b>	<b>4-20mA Positive</b>
<b>BLACK</b>	<b>4-20mA Negative (same as green)</b>
<b>GREEN</b>	<b>-RV and RVVO negative (same as black)</b>
<b>WHITE</b>	<b>+RV and RVVO positive</b>

**Note:**

-The RV and RVVO Signal Negative has to be isolated from any grounding. If this terminal is grounded, the 4-20mA loop will short, causing no output.

-The RV and RVVO output signal is ideally suited for use with portable battery powered data collectors or analyzers.

**TO Option**

The TO (Temperature Output) option includes an additional independent 4-20mA output for temperature measurement. The temperature range is from -40°C to 125°C with an overall accuracy of  $\pm 5\%$ FSO. The imbedded temperature sensor monitors the environment internal to the sensor housing and is situated at approximately mid level.

**Figure 4 – TO wiring**

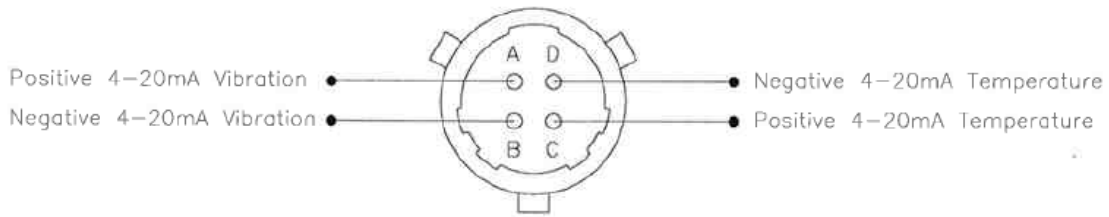

For integral cable sensors:

<b>RED</b>	<b>4-20mA Vibration Positive</b>
<b>BLACK</b>	<b>4-20mA Vibration Negative</b>
<b>GREEN</b>	<b>4-20mA Temperature Negative</b>
<b>WHITE</b>	<b>4-20mA Temperature Positive</b>

**Note:**

- The same power supply can be used for both 4-20mA loops. Connect both positive terminals directly to the power supply, then use the negative terminals for independent process loops.

## Installation

When choosing a mounting method, consider closely the advantages and disadvantages of each technique. Typical mounting types are stud, direct adhesive, adhesive mounting base and magnetic mounting base. Since the frequency response is limited to 1 kHz on the 640/641, any of the four methods can be used without seriously affecting the data values. The mounting method might affect some of the 645/646 series because of the increased frequency response.

### **Direct Adhesive Mount Procedure**

For restrictions of space or for convenience, most sensors (with the exception of integral stud models) can be adhesive-mounted directly to the machine surface.

**STEP 1** Prepare a smooth, flat surface. A minimum surface finish of 63  $\mu\text{in}$  [0.0016 mm] generally works best.

**STEP 2** Place a small portion of adhesive on the underside of the sensor. Firmly press down on the top of the assembly to displace any adhesive. Be aware that excessive amounts of adhesive can make sensor removal difficult.

**Figure 5– direct adhesive mounting**

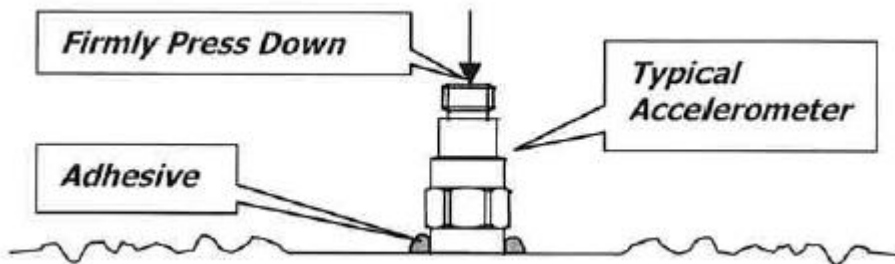

### **Standard Stud Mount Procedure**

This mounting technique requires smooth, flat contact surfaces for proper operation and is recommended for permanent and/or secure installations. Stud mounting is also recommended when testing at high frequencies.

**Note:** DO NOT attempt mounting on curved, rough or uneven surfaces, as the potential for misalignment and limited contact surface may significantly reduce the sensor's upper operating frequency range.

#### **Figure 6– direct adhesive mounting**

<b>1/4-28 stud</b>	<b>1/4-28 Captive Screw-*</b>	
A (in)	0.250	0.250
B (in)	0.350	0.350
Torque (ft-lb)	2 to 5	2 to 5

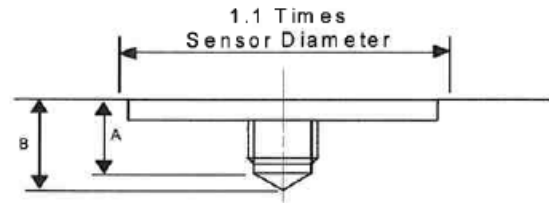

**STEP 1** First, prepare a smooth, flat mounting surface, and then drill and tap a mounting hole in the center of this area as shown in Figure 6. A precision-machined mounting surface with a minimum finish of 63  $\mu\text{in}$  [0.0016 mm] is recommended. (If it is not possible to properly prepare the machine surface, consider using an adhesive mounting pad as a possible alternative.) Inspect the area, checking that there are no burrs or other foreign particles interfering with the contact surface.

**STEP 2** Wipe clean the mounting surface and spread on a light film of grease, oil or similar coupling fluid prior to installation.

#### **Figure 7– mounting surface lubrication.**



Adding a coupling fluid improves vibration transmissibility by filling small voids in the mounting surface and increasing the mounting stiffness. For semi-permanent mounting, substitute epoxy or another type of adhesive.

**STEP 3 HAND** – tighten the sensor/mounting stud to the machine, then secure the sensor with a torque wrench to the mounting surface by applying the recommended mounting torque ( see enclosed specification data sheet for proper mounting torque). It is important to use a torque wrench during this step. **Under-torquing the sensor may not adequately couple the device; over-torquing may result in stud failure and possible permanent damage.**

### **Adhesive Stud Mount Procedure**

Adhesive mounting is often used for temporary installation or when the machine surface cannot be adequately prepared for stud mounting. Adhesives like hot glue or wax work well for temporary mounts; two-part epoxies and quick –bonding gels provide a more permanent mount.

**Note:** Adhesively mounted sensors often exhibit a reduction in high-frequency range. Generally, smooth surfaces and stiff adhesives provide the best frequency response.

This method involves attaching a base to the machine surface, then securing the sensor to the base. This allows for easy removal of the accelerometer.

**STEP 1** Prepare a smooth, flat mounting surface. A minimum surface finish of 63  $\mu\text{in}$  [0.0016 mm] generally works best.

**STEP 2** Stud-mount the sensor to the appropriate adhesive mounting base according to the guidelines set forth in Steps 2 and 3 of the *Standard Stud Mount Procedure*.

**STEP 3** Place a small portion of adhesive on the underside of the mounting base. Firmly press down on the assembly to displace any extra adhesive remaining under the base.

**Figure 8– mounting base: adhesive installation**





### **Magnetic Mount Procedure**

Magnetic mounting provides a convenient means for making portable measurements and is commonly used for machinery monitoring and other portable or tending applications.

**Note:** The correct magnet choice and an adequately prepared mounting surface is critical for obtaining reliable measurements, especially at high frequencies. Poor installations can cause as much as a 50% drop in the sensor frequency range.

***Not every magnet is suitable for all applications. For example, rare earth magnets are commonly used because of their high strength. Flat magnets work well on smooth, flat surfaces, while dual-rail magnets are required for curved surfaces. In the case of non-magnetic or rough surfaces, it is recommended that the user first weld, epoxy or otherwise adhere a steel mounting pad to the test surface. This provides a smooth and repeatable location for mounting.***

**Figure 9– magnet types**

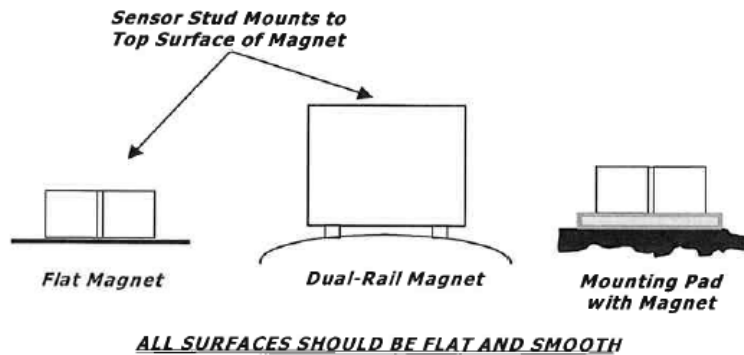

**STEP 1** After choosing the correct magnet type, inspect the unit, verifying that the mounting surfaces are flat and smooth.

**STEP 2** Stud- mount the accelerometer to the appropriate magnet according to the guidelines set forth in Steps 2 and 3 of the Standard Stud Mount Procedure.

**STEP 3** Prepare a smooth, flat mounting surface. A minimum surface finish of 63  $\mu\text{in}$  [0.0016 mm] generally works best. After cleaning the surface and checking for burrs, wipe on a light film of silicone grease, machine oil or similar-type coupling fluid.

**STEP 4** Mount the magnet/sensor assembly to the prepared test surface by gently ‘rocking’ or ‘sliding’ it into place.

**Note:** Magnetically mounting accelerometers carelessly as the potential to generate very high ( and very damaging) g levels. To prevent damage, install the assembly gently. If unsure, please contact the factory for assistance.

## **Warning 1 – ESD sensitivity**

---

**The power supply/signal conditioner should not be opened by anyone other than qualified service personnel.** This product is intended for use by qualified personnel who recognize shock hazards and are familiar with the safety precautions required to avoid injury.

## **Warning 2 – ESD sensitivity**

---

This equipment is designed with user safety in mind; however, the protection provided by the equipment may be impaired if the equipment is used in a manner not specified by PCB Piezotronics, Inc.

## **Caution 1 – ESD sensitivity**

---

**Cables can kill your equipment.** High voltage electrostatic discharge (ESD) can damage electrical devices. Similar to a capacitor, a cable can hold a charge caused by triboelectric transfer, such as that which occurs in the following:

- *Laying on and moving across a rug,*
- *Any movement through air,*
- *The action of rolling out a cable, and/or*
- *Contact with a non-grounded person.*

**The solution for product safety:**

- *Connect the cables only with the AC power off.*
- *Temporarily “short” the end of the cable before attaching it to any signal input or output.*

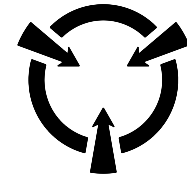

**CAUTION**  
ELECTROSTATIC  
DISCHARGE SENSITIVE

## **Caution 2 – ESD sensitivity**

---

**ESD considerations should be made prior to performing any internal adjustments on the equipment.** Any piece of electronic equipment is vulnerable to ESD when opened for adjustments. Internal adjustments should therefore be done ONLY at an ESD-safe work area. Many products have ESD protection, but the level of protection may be exceeded by extremely high voltage.



## **Warranty**

---

IMI instrumentation is warranted against defective material workmanship for 1 year unless otherwise expressly specified. Damage to instruments caused by incorrect power or misapplication, is not covered by warranty. *If there are any questions regarding power, intended application, or general usage, please consult with your local sales contact or distributor.* Batteries or expendable hardware items are not covered by warranty.

## **Service**

---

Because of the sophisticated nature of IMI instrumentation, field repair is typically **NOT** recommended and may void any warranty. If factory service is required, return the instrumentation according to the "Return Procedure" stated below. *A repair and/or replacement quotation will be provided prior to servicing at no charge.* Before returning the unit, please consult a factory IMI applications engineer concerning the situation as certain problems can often be corrected with simple on-site procedures.

## **Return procedure**

---

*To expedite returned instrumentation, contact a factory IMI applications engineer for RETURN MATERIAL AUTHORIZATION (RMA) NUMBER.* Please have information available such as model and serial number. Also, to insure efficient service, *provide a written description of the symptoms and problems with the equipment to a local sales representative or distributor, or contact IMI if none are located in your area.*

Customers outside the U.S. should consult their local IMI distributor for information on returning equipment. For exceptions, please contact that International Sales department at IMI to request shipping instructions and an RMA. For assistance, please call (716) 684-0003, or fax us at (716) 684-3823. You may also receive assistance via e-mail at [imi@pcb.com](mailto:imi@pcb.com) or visit our website at [www.pcb.com](http://www.pcb.com).

## **Customer Service**

---

IMI, a division of PCB Piezotronics, guarantees **Total Customer Satisfaction**. If, at any time, for any reason, you are not completely satisfied with any IMI product, IMI will repair, replace or exchange it at no charge. You may also choose to have your purchase price refunded.

IMI offers to all customers, at no charge, 24-hour phone support. This service makes product or application support available to our customers, day or night, seven days a week. When unforeseen problems or emergency situations arise, call the **IMI Hot Line at (716) 684-0003**, and an application specialist will assist you.

Model Number  
TO641B31

# 4-20 MA OUTPUT VELOCITY SENSOR WITH TEMPERATURE

Revision: B  
ECN #: 34059

	<u>ENGLISH</u>	<u>SI</u>	
<b>Performance</b>			
Measurement Range(Vibration)	0.0 to 1.0 in/sec rms	0.0 to 25.4 mm/s rms	[2]
(Temperature)	-40 to 257 °F	-40 to 125 °C	[1]
Output	4-20 mA	4-20 mA	
Frequency Range(± 10 %)	600 to 60,000 cpm	10 to 1 kHz	[3][4]
Broadband Resolution	0.005 in/sec rms	0.13 mm/s rms	[5]
Non-Linearity	1 %	1 %	
<b>Environmental</b>			
Temperature Range	-40 to 185 °F	-40 to 85 °C	[1]
<b>Electrical</b>			
Excitation Voltage	12 to 30 VDC	12 to 30 VDC	
Settling Time	<15 sec	<15 sec	
Electrical Isolation(Case)	>10 <sup>8</sup> ohm	>10 <sup>8</sup> ohm	
<b>Physical</b>			
Size (Hex x Height)	1.00 in x 2.60 in	25.4 mm x 66.0 mm	
Weight	4.7 oz	131 gm	
Mounting Thread	1/4-28 UNF	1/4-28 UNF	
Mounting Torque	3 to 5 ft-lb	4 to 7 N-m	
Sensing Element	Ceramic	Ceramic	
Sensing Geometry	Shear	Shear	
Housing Material	Stainless Steel	Stainless Steel	
Sealing	Welded Hermetic	Welded Hermetic	
Electrical Connector	4-Pin Bayonet	4-Pin Bayonet	
Electrical Connection Position	Top	Top	
Electrical Connections(Pin A)	Vibration, 4-20 mA Pos.	Vibration, 4-20 mA Pos.	
(Pin B)	Vibration, 4-20 mA Neg.	Vibration, 4-20 mA Neg.	
(Pin C)	Temperature, 4-20 mA Pos.	Temperature, 4-20 mA Pos.	
(Pin D)	Temperature, 4-20 mA Neg.	Temperature, 4-20 mA Neg.	

**OPTIONAL VERSIONS**

Optional versions have identical specifications and accessories as listed for the standard model except where noted below. More than one option may be used.

**EX - Hazardous Area Approval- contact factory for specific approvals**

Hazardous Area Approval Ex ia IIC T4, -40°C≤Tas80°C, II 1 G Ex ia IIC T4, -40°C≤Tas80°C, II 1 G

Ex nA IIC T4, -40°C≤Tas80°C, II 3 G Ex nA IIC T4, -40°C≤Tas80°C, II 3 G

DIV I, CL I, II, III, GRPS A-G, Exia, AExia, IIC T4 DIV I, CL I, II, III, GRPS A-G, Exia, AExia, IIC T4

DIV II, CL I, GRPS A-D, ExnL, AExnA, IIC T4 DIV II, CL I, GRPS A-D, ExnL, AExnA, IIC T4

**M - Metric Mount**  
Supplied Accessory : Model M081A61 Mounting Stud 1/4-28 to M6 X 1 (1) replaces Model 081A40

**NOTES:**

[1] Vibration 4-20mA output accuracy is limited to 185°F (85°C)

[2] Conversion Factor 1 in/sec = 0.0254 m/sec.

[3] 1Hz = 60 cpm (cycles per minute).

[4] Current will fluctuate at frequencies below 5 Hz.

[5] Typical value.

[6] See PCB Declaration of Conformance PS039 for details.

**SUPPLIED ACCESSORIES:**

Model 081A40 Mounting Stud (1)

Model ICS-4 NIST-traceable single-axis amplitude response calibration from 0 cpm (0 Hz) to upper 10% frequency for 4 - 20 mA output vibration sensor

Entered: <i>SLH</i>	Engineer: <i>DOBT</i>	Sales: <i>MPN</i>	Approved: <i>EB</i>	Spec Number:
Date: <i>9-30-10</i>	Date: <i>9-17-10</i>	Date: <i>9-27-10</i>	Date: <i>9-28-10</i>	37431

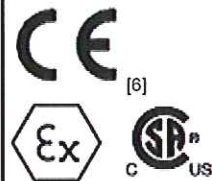

All specifications are at room temperature unless otherwise specified.  
In the interest of constant product improvement, we reserve the right to change specifications without notice.

ICP® is a registered trademark of PCB Group, Inc.

**IMI SENSORS**  
A PCB PIEZOTRONICS DIV.  
3425 Walden Avenue, Depew, NY 14043

Phone: 800-959-4464  
Fax: 716-684-3823  
E-Mail: imi@pcb.com

APPLICATION

REVISIONS

NEXT ASSY	USED ON	VAR

REV	DESCRIPTION	ECN	APP'D
NR	RELEASED TO DRAFTING		DM 3/04

25371

PCB Piezotronics Inc. claims proprietary rights in the information disclosed hereon. Neither it nor any reproduction thereof will be disclosed to others without the written consent of PCB Piezotronics Inc.

TOP VIEW OF CONNECTOR

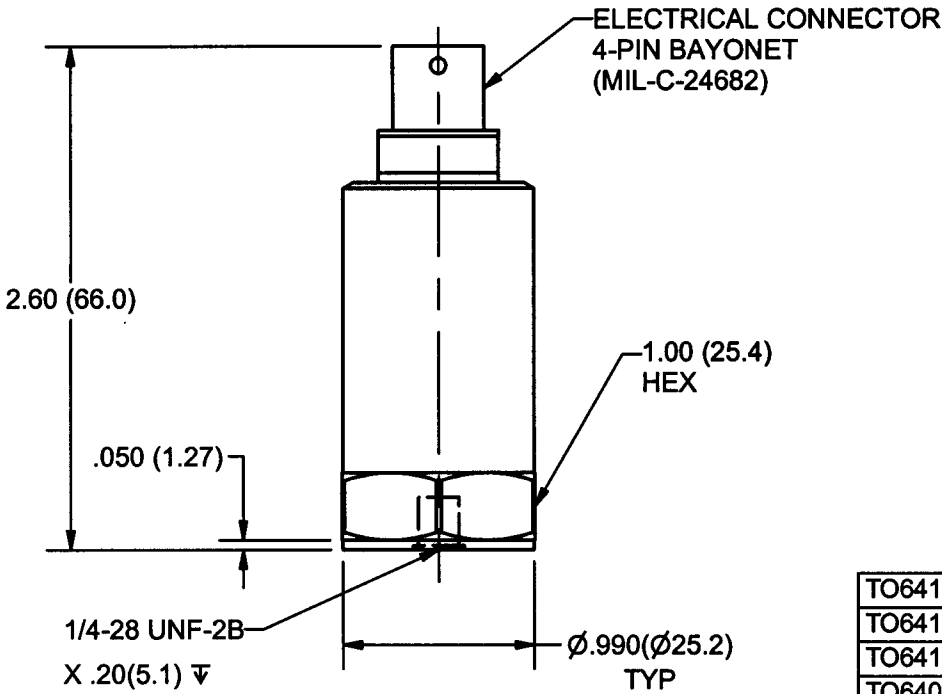
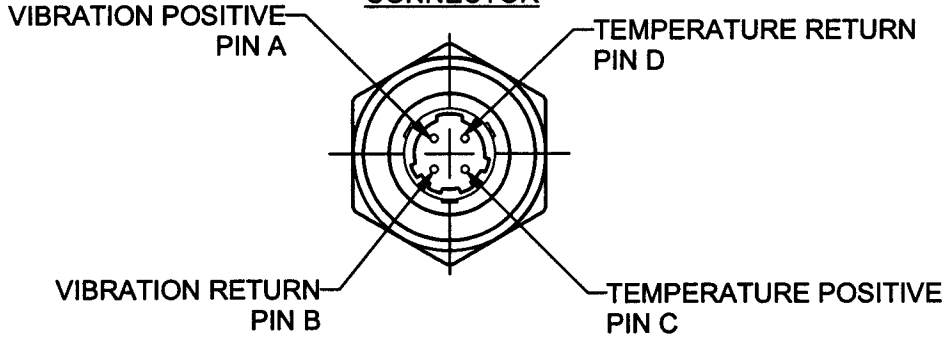

TO641B32	0-2 IPS RMS, 10Hz-1kHz
TO641B31	0-1 IPS RMS, 10Hz-1kHz
TO641B30	0 - 0.5 IPS RMS, 10Hz-1Hz
TO640B32	0-2 IPS PK, 3Hz-1kHz
TO640B31	0-1 IPS PK, 3Hz-1kHz
TO640B30	0-0.5 IPS PK, 3Hz-1kHz
MODEL	DESCRIPTION

UNLESS OTHERWISE SPECIFIED TOLERANCES ARE:

DIMENSIONS IN INCHES	DIMENSIONS IN MILLIMETERS [IN BRACKETS]
DECIMALS XX ± .01	DECIMALS X ± 0.3
XXX ± .005	XX ± 0.13
ANGLES ± 2 DEGREES	ANGLES ± 2 DEGREES

FILLETS AND RADII .003 - .005	FILLETS AND RADII [0.07 - 0.13]
-------------------------------	---------------------------------

DRAWN	MPS 3/18/04	MFG	KMB 3/19/04
CHK'D	DM 3/19/04	ENGR	MJE 3/19/04
APP'D	N/A 2/18/04	SALES	AD 3/19/04

TITLE  
**OUTLINE DRAWING**  
**MODEL TO640B3X, TO641B3X**  
**4-20mA VELOCITY TRANSMITTER**

**PCB PIEZOTRONICS™**

3425 WALDEN AVE. DEPEW, NY 14043  
(716) 684-0001 E-MAIL: sales@pcb.com

CODE IDENT. NO. 52681	DWG. NO. 25371
-----------------------	----------------

SCALE: FULL SHEET 1 OF 1

**ATEX Approved Sensors**  
Vibration Sensors (4-20mA)  
(EXTO64XB Series)

**English**

This sensor has been approved for Hazardous Locations Directive 94/9/EC, Ex ia IIC T4 and Ex nL IIC T4.

For safe use:

- All applicable local electrical laws must be followed
- The apparatus must only be connected to a certified associated intrinsically safe equipment and this combination must be compatible as regards intrinsic safety rules.
- The electrical parameters of the associated intrinsically safe equipment must not exceed any of the following values:
  - o  $U_o \leq 28V$ ,  $I_o \leq 120mA$ ,  $P_o \leq 1W$
- Ambient operating temperature range:
  - o  $-40^{\circ}C$  to  $+80^{\circ}C$

**Deutsch**

Die Sensoren der o. g. Serie wurden gemäß der EU-Richtlinie 94/9/EC, Ex ia IIC T4 und Ex nL IIC T4 ("Komponenten und Schutzsysteme für explosionsgefährdete Bereiche") zertifiziert.

Für den ordnungsgemäßen und sicheren Betrieb:

- müssen alle gültigen Gesetze und Vorschriften eingehalten werden
- darf der Transmitter ausschließlich an passendem, zugelassenem, eigensicherem Equipment angeschlossen werden und diese Kombination muss den Bestimmungen des Explosionsschutzes entsprechen
- dürfen die elektrischen Parameter des zugehörigen eigensicheren Equipments folgende Werte nicht überschreiten:
  - o  $U_o \leq 28V$ ,  $I_o \leq 120mA$ ,  $P_o \leq 1W$
- Umgebungstemperaturbereich:
  - o  $-40^{\circ}C$  to  $+80^{\circ}C$

**Français**

Ce détecteur a été approuvé pour les Emplacements Hasardeux Directif 94/9/EC, Ex ia IIC T4 et Ex nL IIC T4.

Pour l'usage sûr :

- Toutes lois électriques, locales et applicables doivent être suivies
- L'appareil doit être seulement connecté à un équipement intrinsèquement sûr, associé et certifié et cette combinaison doit être compatible comme considère des mesures de sécurité intrinsèques.
- Les paramètres électriques de l'équipement intrinsèquement sûr associé ne doivent pas dépasser n'importe quel des valeurs suivantes :
  - o  $U_o \leq 280V$ ,  $I_o \leq 120mA$ ,  $P_o \leq 1W$
- La gamme de température d'opération Ambiante :
  - o  $-40^{\circ}C$  to  $+80^{\circ}C$

**Italiano**

Questo sensore è stato approvato per le Posizioni Pericolose Direttivo 94/9/EC, Ex ia IIC T4 e Ex nL IIC T4.

Per l'uso sicuro:

- Tutte le leggi applicabili, locali elettriche devono essere seguite
- Il dispositivo deve essere soltanto collegato a un'apparecchiatura certificata, associata intrinsecamente sicura e questa combinazione deve essere compatibile considera come le regole di sicurezza intrinseche.
- I parametri elettrici dell'apparecchiatura associata intrinsecamente sicura non devono eccedere qualunque dei valori seguenti:
  - o  $U_o \leq 28V$ ,  $I_o \leq 120mA$ ,  $P_o \leq 1W$
- la gamma di temperatura di funzionamento di Ambiente:
  - o  $-40^{\circ}C$  to  $+80^{\circ}C$

**Español**

Este sensor se ha aprobado para Ubicaciones Peligrosas Directivas 94/9/EC, Ex ia IIC T4 y Ex nL IIC T4.

Para el uso seguro:

- Todas leyes eléctricas, locales y aplicables se deben seguir
- El aparato debe sólo sea conectado a un equipo intrínsecamente seguro, asociado y certificado y esta combinación debe ser compatible considera como las reglas intrínsecas de la seguridad.
- Los parámetros eléctricos del equipo intrinsecamente seguro asociado no deben exceder cualquiera de los valores siguientes:
  - o  $U_o \leq 28V$ ,  $I_o \leq 120mA$ ,  $P_o \leq 1W$
- El Ambiente que opera la gama de la temperatura:
  - o  $-40^{\circ}C$  to  $+80^{\circ}C$

### Русский

Директивой 94/9/EC настоящий датчик разрешен к применению по категориям, Ex ia IIC T4 и Ex nL IIC T4.

Для безопасного использования:

- все правила электробезопасности должны быть выполнены.
- датчик может быть подключен только к сертифицированному оборудованию и соединение должно соответствовать правилам электробезопасности.
- контактирующее с датчиком оборудование не должно выходить за следующие предельные значения:
  - o  $U_o \leq 28V$ ,  $I_o \leq 120mA$ ,  $P_o \leq 1W$
- Диапазон рабочих температур:
  - o  $-40^{\circ}C$  to  $+80^{\circ}C$

### Norsk

Denne sensoren godkjenner for Farlige Plasseringer Direktiv 94/9/EC, Ex ia IIC T4 og Ex nL IIC T4.

For sikker bruk:

- Alle anvendelige lokale elektriske lover fulgt
- Apparatet koplet bare til et sertifisert tilknyttet indre sikkert utstyr og denne kombinasjonen er forenelig med hensyn til indre sikkerhetsregel.
- De elektriske parametrene av det tilknyttete indre sikkeret utstyret overskrider ikke noe av de følgende verdiene:
  - o  $U_o \leq 28V$ ,  $I_o \leq 120mA$ ,  $P_o \leq 1W$
- Omgivende betjeningsav temperaturrekkevidde:
  - o  $-40^{\circ}C$  to  $+80^{\circ}C$

### Nederlands

Deze sensor is voor Gevaarlijke Locaties Leidinggevende 94/9/EC, Ex ia IIC T4 en Ex nL IIC T4 goedgekeurd worden.

Voor veilige gebruik:

- Alle toepasbare plaatselijke elektrische wetten moeten gevolgd worden
- Het apparaat moet enkel aan een gecertificeerde geassocieerde intrinsiek veilige uitrusting aangesloten worden en deze combinatie moet compatibel zijn als intrinsieke veiligheidsregels beschouwt.
- De elektrische parameters van de geassocieerde intrinsiek veilige uitrusting moeten enig van de volgende waarde niet overschrijden:
  - o  $U_o \leq 28V$ ,  $I_o \leq 120mA$ ,  $P_o \leq 1W$
- Het omgevend bediening temperatuur bereik:
  - o  $-40^{\circ}C$  to  $+80^{\circ}C$

### Polski

Ten sensor ma być uznany pod kątem Hazardowy Rozmieszczenia Kierujący 94/9/EC Ex ia IIC T4 i Ex nL IIC T4.

Pod kątem kasa używać :

- Wszystko stosowny miejscowy elektryczny łąsk musi być nastąpił
- Ten aparat musi tylko być połączony wobec pewien poświadczony złączony wewnętrznie kasa wyposażenie i ten kombinacja musi być zgodny z co się tyczy wewnętrzny przepisy bezpieczeństwa.
- Ten elektryczny parametry od ten złączony wewnętrznie kasa wyposażenie musi nie przewyższać wszelki od ten kolejne wartość :
  - o  $U_o \leq 28V$ ,  $I_o \leq 120mA$ ,  $P_o \leq 1W$
- Otaczający pracy temperatura rząd :
  - o  $-40^{\circ}C$  to  $+80^{\circ}C$

### Português

Este sensor foi aprovado para a Diretiva 94/9/EC de Posições Arriscada, Ex ia IIC T4 e Ex nL IIC T4.

Para uso seguro:

- Todas as leis elétricas locais aplicáveis devem ser seguidas
- O aparelho só deve ser unido a um equipamento associado intrinsecamente seguro certificado e esta combinação deve ser compatível quanto a regras de segurança intrínsecas.
- Os parâmetros elétricos do equipamento associado intrinsecamente seguro não devem exceder nenhum dos valores seguintes:
  - o  $U_o \leq 28V$ ,  $I_o \leq 120mA$ ,  $P_o \leq 1W$
- Variedade de temperatura operacional ambiente:
  - o  $-40^{\circ}C$  to  $+80^{\circ}C$

### Svensk

Den här sensoren er blitt gillat för Riskabel Lokaliseringarna Direktiv 94/9/ EC Ex ia IIC T4 och Ex nL IIC T4.

För kassaskåp använda :

- All användbar lokal elektrisk lag måste bli följd efter
- Apparaten måste bara bli kopplet till en attesterat förbundet intrinsically kassaskåp utrustande och den här kombination måste bli förenlig vad angår intrinsic säkerhet reglerna.
- Den elektrisk paramenterna om förbundet intrinsically kassaskåp utrustande må inte överskrida någon av den följande värden :
  - o  $U_o \leq 28V$ ,  $I_o \leq 120mA$ ,  $P_o \leq 1W$
- Omgivande opera- temperatur ställa i rad :
  - o  $-40^{\circ}C$  to  $+80^{\circ}C$



# Certificate of Compliance

**Certificate:** 1632187

**Master Contract:** 184981

**Project:** 80014642

**Date Issued:** 2019-11-26

**Issued To:** PCB Piezotronics  
3425 Walden Ave  
Depew, New York, 14043  
United States

**Attention:** Carrie Termin



**Issued by:** *Jignesh Dabhi*  
Jignesh Dabhi

## PRODUCTS

**CLASS 2258 04** - PROCESS CONTROL EQUIPMENT - Intrinsically Safe Entity - For Hazardous Locations  
**CLASS 2258 84** - PROCESS CONTROL EQUIPMENT - Intrinsically Safe Entity - For Hazardous Locations -  
CERTIFIED TO U.S. STANDARDS

**Class I, Div. 1, Groups A, B, C and D; Class II, Div. 1, Groups E, F and G; Class III, Div 1:**

**Exia IIC T4:**

**AEx ia IIC T4:**

Models EX64xB0y Vibration Sensors, input rated 28V dc max, 20mA; intrinsically safe with entity parameters of:  $U_i$  (V max) = 30V,  $I_i$  (I max) = 100mA,  $P_i$  = 1W,  $C_i$  = 0,  $L_i$  = 1.06 uH; when installed per installation Dwg 27534; Temp Code T4 @ Max Ambient 80 Deg C.

Models 9842VCRT Vibration Sensors, input rated 28V dc max, 20mA; intrinsically safe with entity parameters of:  $U_i$  (V max) = 30V,  $I_i$  (I max) = 100mA,  $P_i$  = 1W,  $C_i$  = 0,  $L_i$  = 1.06 uH; when installed per installation Dwg 36576; Temp Code T4 @ Max Ambient 80 Deg C.

Models EX64xB1y and EX64xB6y Vibration Sensors, input rated 28V dc max, 20mA; intrinsically safe with entity parameters of:  $U_i$  (V max) = 30V,  $I_i$  (I max) = 100mA,  $P_i$  = 1W,  $C_i$  = 61 nF,  $L_i$  = 306 uH; when installed per installation Dwg 27534; Temp Code T4 @ Max Ambient 80 Deg C.

Models EXTO64xB3y Vibration Sensors, input rated 28V dc max, 20mA; intrinsically safe with entity parameters of:  $U_i$  (V max) = 28V,  $I_i$  (I max) = 120mA,  $P_i$  = 1W,  $C_i$  = 0,  $L_i$  = 1.06 uH; when installed per installation Dwg 27536; Temp Code T4 @ Max Ambient 80 Deg C.





Models EXTO64xB1y and EXTO64xB6y Vibration Sensors, input rated 28V dc max, 20mA; intrinsically safe with entity parameters of:  $U_i$  (V max) = 28V,  $I_i$  (I max) = 120mA,  $P_i$  = 1W,  $C_i$  = 61 nF,  $L_i$  = 306  $\mu$ H; when installed per installation Dwg 27536; Temp Code T4 @ Max Ambient 80 Deg C.

Models EXRV64xB0y Vibration Sensors, input rated 28V dc max, 20mA; intrinsically safe with entity parameters of:  $U_i$  (V max) = 28V,  $I_i$  (I max) = 120mA,  $P_i$  = 1W,  $C_i$  = 0,  $L_i$  = 121.06  $\mu$ H; when installed per installation Dwg 30538; Temp Code T4 @ Max Ambient 80 Deg C.

Models EXRV64xB1y and EXRV64xB6y Vibration Sensors, input rated 28V dc max, 20mA; intrinsically safe with entity parameters of:  $U_i$  (V max) = 28V,  $I_i$  (I max) = 120mA,  $P_i$  = 1W,  $C_i$  = 61 nF,  $L_i$  = 426  $\mu$ H; when installed per installation Dwg 30538; Temp Code T4 @ Max Ambient 80 Deg C.

Models EX64xB7y Vibration Sensors, input rated 28V dc max, 20mA; intrinsically safe with entity parameters of:  $U_i$  (V max) = 30V,  $I_i$  (I max) = 100mA,  $P_i$  = 1W,  $C_i$  = 0,  $L_i$  = 1.06  $\mu$ H; when installed per installation Dwg 28766; Temp Code T4 @ Max Ambient 80 Deg C.

Models EXTO64xB7y Vibration Sensors, input rated 28V dc max, 20mA; intrinsically safe with entity parameters of:  $U_i$  (V max) = 28V,  $I_i$  (I max) = 120mA,  $P_i$  = 1W,  $C_i$  = 0,  $L_i$  = 1.06  $\mu$ H; when installed per installation Dwg 28767; Temp Code T4 @ Max Ambient 80 Deg C.

Models EXRV64xB7y Vibration Sensors, input rated 28V dc max, 20mA; intrinsically safe with entity parameters of:  $U_i$  (V max) = 28V,  $I_i$  (I max) = 120mA,  $P_i$  = 1W,  $C_i$  = 0,  $L_i$  = 1.06  $\mu$ H; when installed per installation Dwg 29987; Temp Code T4 @ Max Ambient 80 Deg C.

Note: The "x" in the model code may be a 0 to 9, which denotes variations in frequency response range of the sensors. The "y" in the model code may be a 0 to 9, which denotes variations in sensor sensitivity.

Models EX64xA0y Vibration Sensors, input rated 28V dc max, 20mA; intrinsically safe with entity parameters of:  $U_i$  (V max) = 30V,  $I_i$  (I max) = 100mA,  $P_i$  = 1W,  $C_i$  = 0,  $L_i$  = 1.06  $\mu$ H; when installed per installation Dwg 27535; Temp Code T4 @ Max Ambient 80 Deg C.

Models 9942VCRT Vibration Sensors, input rated 28V dc max, 20mA; intrinsically safe with entity parameters of:  $U_i$  (V max) = 30V,  $I_i$  (I max) = 100mA,  $P_i$  = 1W,  $C_i$  = 0,  $L_i$  = 1.06  $\mu$ H; when installed per installation Dwg 36578; Temp Code T4 @ Max Ambient 80 Deg C.

Models EX64xA1y and EX64xA6y Vibration Sensors, input rated 28V dc max, 20mA; intrinsically safe with entity parameters of:  $U_i$  (V max) = 30V,  $I_i$  (I max) = 100mA,  $P_i$  = 1W,  $C_i$  = 61 nF,  $L_i$  = 306  $\mu$ H; when installed per installation Dwg 27535; Temp Code T4 @ Max Ambient 80 Deg C.

Models EXTO64xA3y Vibration Sensors, input rated 28V dc max, 20mA; intrinsically safe with entity parameters of:  $U_i$  (V max) = 28V,  $I_i$  (I max) = 120mA,  $P_i$  = 1W,  $C_i$  = 0,  $L_i$  = 1.06  $\mu$ H; when installed per installation Dwg 27537; Temp Code T4 @ Max Ambient 80 Deg C.

Models EXTO64xA1y and EXTO64xA6y Vibration Sensors, input rated 28V dc max, 20mA; intrinsically safe with entity parameters of:  $U_i$  (V max) = 28V,  $I_i$  (I max) = 120mA,  $P_i$  = 1W,  $C_i$  = 61 nF,  $L_i$  = 306  $\mu$ H; when installed per installation Dwg 27537; Temp Code T4 @ Max Ambient 80 Deg C.



Models EXRV64xA0y Vibration Sensors, input rated 28V dc max, 20mA; intrinsically safe with entity parameters of:  $U_i$  (V max) = 28V,  $I_i$  (I max) = 120mA,  $P_i$  = 1W,  $C_i$  = 0,  $L_i$  = 121.06 uH; when installed per installation Dwg 30540; Temp Code T4 @ Max Ambient 80 Deg C.

Models EXRV64xA1y and EXRV64xA6y Vibration Sensors, input rated 28V dc max, 20mA; intrinsically safe with entity parameters of:  $U_i$  (V max) = 28V,  $I_i$  (I max) = 120mA,  $P_i$  = 1W,  $C_i$  = 61 nF,  $L_i$  = 426 uH; when installed per installation Dwg 30540; Temp Code T4 @ Max Ambient 80 Deg C.

Models CS64xB9y Vibration Sensors, input rated 28V dc max, 20mA; intrinsically safe with entity parameters of:  $U_i$  (V max) = 30V,  $I_i$  (I max) = 100mA,  $P_i$  = 1W,  $C_i$  = 0,  $L_i$  = 1.06 uH; when installed per Dwg 56140; Temp Code T4 @ Max Ambient 80 Deg C.

Note: The "x" in the model code may be a 0 to 9, which denotes variations in frequency response range of the sensors. The "y" in the model code may be a 0 to 9, which denotes variations in sensor sensitivity.

### APPLICABLE REQUIREMENTS

CAN/CSA-C22.2 No. 0-M91	- General Requirements – Canadian Electrical Code, Part II
C22.2 No. 142-M1987 (R2009)	- Process Control Equipment
CAN/CSA-C22.2 No. 157-92 (R2012)	- Intrinsically Safe and Non-Incendive Equipment for Use in Hazardous Locations
UL 913 (7 <sup>th</sup> Ed.)	- Intrinsically Safe Apparatus and Associated Apparatus for Use in Class I, II and III, Division 1, Hazardous Locations
UL 916 (4 <sup>th</sup> Ed.)	- Energy Management Equipment
CAN/CSA-E60079-0:07	- Electrical apparatus for explosive gas atmospheres - Part 0: General Requirements
CAN/CSA-E60079-11:02	- Electrical apparatus for explosive gas atmospheres - Part 11: Intrinsic Safety "i"
ANSI/UL 60079-0:05	- Electrical Apparatus for Explosive Gas Atmospheres - Part 0: General Requirements
ANSI/UL 60079-11:07	- Electrical apparatus for Explosive Gas Atmospheres - Part 11: Intrinsic Safety "i"

**CLASS 2258 03** - PROCESS CONTROL EQUIPMENT - Intrinsically Safe and Non-Incendive Systems - For Hazardous Locations

**CLASS 2258 83** - PROCESS CONTROL EQUIPMENT - Intrinsically Safe and Non-Incendive Systems - For Hazardous Locations - CERTIFIED TO U.S. STANDARDS

**Ex nL IICT4:**

**AEx nA IICT4:**

**Class I, Div. 2, Groups A, B, C, D:**

Models EX64xB0y Vibration Sensors, input rated 28V dc max, 20mA; non-incendive with entity parameters of:  $U_i$  (V max) = 30V,  $I_i$  (I max) = 100mA,  $P_i$  = 1W,  $C_i$  = 0,  $L_i$  = 1.06 uH; when installed per installation Dwg 27534; Temp Code T4 @ Max Ambient 80 Deg C.



Models 9842VCRT Vibration Sensors, input rated 28V dc max, 20mA; non-incendive with entity parameters of:  $U_i$  (V max) = 30V,  $I_i$  (I max) = 100mA,  $P_i$  = 1W,  $C_i$  = 0,  $L_i$  = 1.06 uH; when installed per installation Dwg 36576; Temp Code T4 @ Max Ambient 80 Deg C.

Models EX64xB1y and EX64xB6y Vibration Sensors, input rated 28V dc max, 20mA; non-incendive with entity parameters of:  $U_i$  (V max) = 30V,  $I_i$  (I max) = 100mA,  $P_i$  = 1W,  $C_i$  = 61 nF,  $L_i$  = 306  $\mu$ H; when installed per installation Dwg 27534; Temp Code T4 @ Max Ambient 80 Deg C.

Models EXTO64xB3y Vibration Sensors, input rated 28V dc max, 20mA; non-incendive with entity parameters of:  $U_i$  (V max) = 28V,  $I_i$  (I max) = 120mA,  $P_i$  = 1W,  $C_i$  = 0,  $L_i$  = 1.06 uH; when installed per installation Dwg 27536; Temp Code T4 @ Max Ambient 80 Deg C.

Models EXTO64xB1y and EXTO64xB6y Vibration Sensors, input rated 28V dc max, 20mA; non-incendive with entity parameters of:  $U_i$  (V max) = 28V,  $I_i$  (I max) = 120mA,  $P_i$  = 1W,  $C_i$  = 61 nF,  $L_i$  = 306  $\mu$ H; when installed per installation Dwg 27536; Temp Code T4 @ Max Ambient 80 Deg C.

Models EXRV64xB0y Vibration Sensors, input rated 28V dc max, 20mA; non-incendive with entity parameters of:  $U_i$  (V max) = 28V,  $I_i$  (I max) = 120mA,  $P_i$  = 1W,  $C_i$  = 0,  $L_i$  = 121.06 uH; when installed per installation Dwg 30538; Temp Code T4 @ Max Ambient 80 Deg C.

Models EXRV64xB1y and EXRV64xB6y Vibration Sensors, input rated 28V dc max, 20mA; non-incendive with entity parameters of:  $U_i$  (V max) = 28V,  $I_i$  (I max) = 120mA,  $P_i$  = 1W,  $C_i$  = 61 nF,  $L_i$  = 426  $\mu$ H; when installed per installation Dwg 30538; Temp Code T4 @ Max Ambient 80 Deg C.

Notes:

1. Sensor case must be bonded to ground according to Section 18-182 of the CEC, Part 1.
2. The "x" in the model code may be a 0 to 9, which denotes variations in frequency response range of the sensors. The "y" in the model code may be a 0 to 9, which denotes variations in sensor sensitivity.

Models EX64xA0y Vibration Sensors, input rated 28V dc max, 20mA; non-incendive with entity parameters of:  $U_i$  (V max) = 30V,  $I_i$  (I max) = 100mA,  $P_i$  = 1W,  $C_i$  = 0,  $L_i$  = 1.06 uH; when installed per installation Dwg 27535; Temp Code T4 @ Max Ambient 80 Deg C.

Models 9942VCRT Vibration Sensors, input rated 28V dc max, 20mA; non-incendive with entity parameters of:  $U_i$  (V max) = 30V,  $I_i$  (I max) = 100mA,  $P_i$  = 1W,  $C_i$  = 0,  $L_i$  = 1.06 uH; when installed per installation Dwg 36578; Temp Code T4 @ Max Ambient 80 Deg C.

Models EX64xA1y and EX64xA6y Vibration Sensors, input rated 28V dc max, 20mA; non-incendive with entity parameters of:  $U_i$  (V max) = 30V,  $I_i$  (I max) = 100mA,  $P_i$  = 1W,  $C_i$  = 61 nF,  $L_i$  = 306  $\mu$ H; when installed per installation Dwg 27535; Temp Code T4 @ Max Ambient 80 Deg C.

Models EXTO64xA3y Vibration Sensors, input rated 28V dc max, 20mA; non-incendive with entity parameters of:  $U_i$  (V max) = 28V,  $I_i$  (I max) = 120mA,  $P_i$  = 1W,  $C_i$  = 0,  $L_i$  = 1.06 uH; when installed per installation Dwg 27537; Temp Code T4 @ Max Ambient 80 Deg C.

Models EXTO64xA1y and EXTO64xA6y Vibration Sensors, input rated 28V dc max, 20mA; non-incendive with entity parameters of:  $U_i$  (V max) = 28V,  $I_i$  (I max) = 120mA,  $P_i$  = 1W,  $C_i$  = 61 nF,  $L_i$  = 306  $\mu$ H; when installed per installation Dwg 27537; Temp Code T4 @ Max Ambient 80 Deg C.



Models EXRV64xA0y Vibration Sensors, input rated 28V dc max, 20mA; non-incendive with entity parameters of:  $U_i$  (V max) = 28V,  $I_i$  (I max) = 120mA,  $P_i$  = 1W,  $C_i$  = 0,  $L_i$  = 121.06 uH; when installed per installation Dwg 30540; Temp Code T4 @ Max Ambient 80 Deg C.

Models EXRV64xA1y and EXRV64xA6y Vibration Sensors, input rated 28V dc max, 20mA; non-incendive with entity parameters of:  $U_i$  (V max) = 28V,  $I_i$  (I max) = 120mA,  $P_i$  = 1W,  $C_i$  = 61 nF,  $L_i$  = 426  $\mu$ H; when installed per installation Dwg 30540; Temp Code T4 @ Max Ambient 80 Deg C.

Models CS64xB9y Vibration Sensors, input rated 28V dc max, 20mA; non-incendive with entity parameters of:  $U_i$  (V max) = 30V,  $I_i$  (I max) = 100mA,  $P_i$  = 1W,  $C_i$  = 0,  $L_i$  = 1.06 uH; when installed per Dwg 56140; Temp Code T4 @ Max Ambient 80 Deg C.

Notes:

1. For Canadian Installations, sensor case must be bonded to ground according to Section 18-182 of the CEC, Part 1.
2. For US Installations, sensor case must be bonded to ground according to Article 501.16 of the NEC.
3. The "x" in the model code may be a 0 to 9, which denotes variations in frequency response range of the sensors. The "y" in the model code may be a 0 to 9, which denotes variations in sensor sensitivity.

**APPLICABLE REQUIREMENTS**

CAN/CSA-C22.2 No. 0-M91	-	General Requirements – Canadian Electrical Code, Part II
C22.2 No. 142-M1987 (R2009)	-	Process Control Equipment
C22.2 No. 213-M1987 (R2008)	-	Non-Incendive Electrical Equipment for Use in Class I, Division 2 Hazardous Locations
UL 916 (4 <sup>th</sup> Ed.)	-	Energy Management Equipment
UL 1604 (3 <sup>rd</sup> Ed.)	-	Electrical Equipment for Use in Class I and II, Division 2; Class III Hazardous (Classified) Locations
ANSI/ISA 12.12.01-2000	-	Nonincendive Electrical Equipment for Use in Class I and II, Division 2 and Class III, Divisions 1 and 2 Hazardous (Classified) Locations
CAN/CSA-E60079-15:02	-	Electrical apparatus for explosive gas atmospheres - Part 15: Type of Protection "n"
ANSI/UL 60079-15:02	-	Electrical apparatus for Explosive Gas Atmospheres - Part 15: Type of Protection "n"

**CLASS 2258 02 - PROCESS CONTROL EQUIPMENT - For Hazardous Locations**

**CLASS 2258 82 - PROCESS CONTROL EQUIPMENT – For Hazardous Locations - CERTIFIED TO U.S. STANDARDS**

**Ex nA IICT4:**

**AEx nA IIC T4:**

**Class I, Div. 2, Groups A, B, C, D:**

Models EX64xB7y Vibration Sensors, input rated 28V dc max, 20mA; suitable for use in Class I, Div. 2 or Class I, Zone 2 locations, when installed per installation Dwg 28766; Temp Code T4 @ Max Ambient 80 Deg C.



Models EXTO64xB7y Vibration Sensors, input rated 28V dc max, 20mA; suitable for use in Class I, Div. 2 or Class I, Zone 2 locations, when installed per installation Dwg 28766; Temp Code T4 @ Max Ambient 80 Deg C.

Models EXRV64xB7y Vibration Sensors, input rated 28V dc max, 20mA; suitable for use in Class I, Div. 2 or Class I, Zone 2 locations, when installed per installation Dwg 28766; Temp Code T4 @ Max Ambient 80 Deg C.

Models CS64xB9y Vibration Sensors, input rated 28V dc max, 20mA; suitable for use in Class I, Div. 2 or Class I, Zone 2 locations, when installed per installation Dwg 56140; Temp Code T4 @ Max Ambient 80 Deg C.

Notes:

1. Sensor must be installed in a suitable enclosure, acceptable to the local inspection authority having jurisdiction.
2. The "x" in the model code may be a 0 to 9, which denotes variations in frequency response range of the sensors. The "y" in the model code may be a 0 to 9, which denotes variations in sensor sensitivity.

**APPLICABLE REQUIREMENTS**

- |                               |   |   |
|-------------------------------|---|---|
| CAN/CSA-C22.2 No. 0-M91       | - | General Requirements – Canadian Electrical Code, Part II  |
| C22.2 No. 142-M1987(R2009)    | - | Process Control Equipment   |
| C22.2 No. 213-M1987(R2008)    | - | Non-Incendive Electrical Equipment for Use in Class I, Division 2 Hazardous Locations   |
| UL 916 (4 <sup>th</sup> Ed.)  | - | Energy Management Equipment   |
| UL 1604 (3 <sup>rd</sup> Ed.) | - | Electrical Equipment for Use in Class I and II, Division 2; Class III Hazardous (Classified) Locations                                    |
| ANSI/ISA 12.12.01-2000        | - | Nonincendive Electrical Equipment for Use in Class I and II, Division 2 and Class III, Divisions 1 and 2 Hazardous (Classified) Locations |
| CAN/CSA-E60079-15:02          | - | Electrical apparatus for explosive gas atmospheres - Part 15: Type of Protection "n"  |
| ANSI/UL 60079-15:02           | - | Electrical apparatus for Explosive Gas Atmospheres - Part 15: Type of Protection "n"  |

**CLASS 2258 04 - PROCESS CONTROL EQUIPMENT - Intrinsically Safe Entity - For Hazardous Locations**

**CLASS 2258 84 - PROCESS CONTROL EQUIPMENT - Intrinsically Safe Entity - For Hazardous Locations - CERTIFIED TO U.S. STANDARDS**

**Ex ia IIC; AEx ia IIC; Class I, Div. 1, Groups A, B, C and D; Class II, Div. 1, Groups E, F and G; Class III; T<sub>amb</sub>: -40C to 121C; Tcode: T3C**

Models EXHT(M)64x (with connector or integral cable), Vibration Sensors, input rated 28V dc max, 20mA; intrinsically safe when installed per installation drawing 71991 (sheet 1);



Models EXHTTO(M)64x (with connector or integral cable), Vibration and Temperature Sensors, input rated 28V dc max, 20mA; intrinsically safe when installed per installation drawing 72010 (sheet 1);

Models EXHT(M)64x (with conduit connection), Vibration Sensors, input rated 28V dc max, 20mA; intrinsically safe when installed per installation drawing 71993 (sheet 1);

Models EXHTTO(M)64x (with conduit connection), Vibration and Temperature Sensors, input rated 28V dc max, 20mA; intrinsically safe when installed per installation drawing 72068 (sheet 1);

**Ex ic IIC; AEx ic IIC; Class I Division 2 Groups A, B, C and D; T<sub>amb</sub>: -40C to 121C; Tcode: T3C**

Models EXHT(M)64x (with connector or integral cable), Vibration Sensors, input rated 28V dc max, 20mA; suitable for use in Class I, Div. 2/ Zone 2 (Ex ic) locations when per installation drawing 71991 (sheet 2);

Models EXHTTO(M)64x (with connector or integral cable), Vibration and Temperature Sensors, input rated 28V dc max, 20mA; suitable for use in Class I, Div. 2/ Zone 2(Ex ic) locations when per installation drawing 72010 (sheet 2);

**Notes:**

1. Sensor must be installed in a suitable enclosure, acceptable to the local inspection authority having jurisdiction.
2. The "x" is a series of letters and numbers in the model for different variations including variation in frequency response, top cable entry, side cable entry and other differences not critical to certification.
3. M in the model number is optional and to include Metric threading adapters instead of English threading adapters

**CLASS 2258 02 - PROCESS CONTROL EQUIPMENT - For Hazardous Locations**

**CLASS 2258 82 - PROCESS CONTROL EQUIPMENT – For Hazardous Locations - CERTIFIED TO U.S. STANDARDS**

**Class I Division 2 Groups A, B, C and D; T<sub>amb</sub>: -40C to 121C; Tcode: T3C**

Models EXHT(M)64x (with conduit connection), Vibration Sensors, input rated 28V dc max, 20mA; Suitable for Class I Division 2 when installed per installation drawing 71993 (sheet 2).

Models EXHTTO(M)64x (with conduit connection), Vibration and Temperature Sensors, input rated 28V dc max, 20mA; Suitable for Class I Division 2 when installed per installation drawing 72068 (sheet 2).

1. Sensor must be installed in a suitable enclosure, acceptable to the local inspection authority having jurisdiction.
2. The "x" is a series of letters and numbers in the model for different variations including variation in frequency response, top cable entry, side cable entry and other differences not critical to certification.
3. M in the model number is optional and to include Metric threading adapters instead of English threading adapters



## APPLICABLE REQUIREMENTS

CSA C22.2 No. 61010-1-12/ ANSI/ISA 61010-1 3rd Ed. (R2017)	- Safety requirements for electrical equipment for measurement, control, and laboratory use — Part 1: General requirements
CSA C22.2 No. 213 2017/ UL 121201 9th Ed.	- Nonincendive Electrical Equipment for Use in Class I and II, Division 2 and Class III, Divisions 1 and 2 Hazardous (Classified) Locations
CSA C22.2 No 60079-0:2019	- Explosive Atmospheres-Part 0: Equipment-General requirements
CSA C22.2 No 60079-11:2014	- Explosive atmospheres — Part 11: Equipment protection by intrinsic safety “i”
UL 60079-0: 2019	Standard for Safety – Explosive Atmospheres – Part 0: Equipment – General Requirements, Ed. 6
UL 60079-11:2014	Standard for Safety – Explosive Atmospheres – Part 11: Equipment Protection by Intrinsic Safety “I”, Ed. 6

## MARKINGS

The manufacturer is required to apply the following markings:

- Products shall be marked with the markings specified by the particular product standard.
- Products certified for Canada shall have all Caution and Warning markings in both English and French.

Additional bilingual markings not covered by the product standard(s) may be required by the Authorities Having Jurisdiction. It is the responsibility of the manufacturer to provide and apply these additional markings, where applicable, in accordance with the requirements of those authorities.

The products listed are eligible to bear the CSA Mark shown with adjacent indicators 'C' and 'US' for Canada and US (indicating that products have been manufactured to the requirements of both Canadian and U.S. Standards) or with adjacent indicator 'US' for US only or without either indicator for Canada only.

Markings are etched directly into the Sensor enclosure body. The following marking details appear:

### I.S. models

- CSA Monogram with C US Indicator
- Submitter Identification
- Model Number
- Serial Number, Date Code or Month and Year of Manufacture
- Electrical Rating
- Hazardous Location Designation- As per Product Section
- Applicable Temperature Code
- Applicable Ambient temperature range
- For EXHT and EXHTTO series: DC symbol: 
- Certificate # reference (ie. 2005 1632187 X)
- Reference to Installation Drawing



#### Div. 2 Non-Incendive models

- CSA Monogram with C US indicator.
- Submitter Identification
- Model Number
- Serial Number, Date Code or Month and Year of Manufacture
- Electrical Rating
- Hazardous Location Designation: As per Product Section
- Applicable Temperature Code
- Applicable Ambient temperature range
- For EXHT and EXHTTO series: DC symbol “    ” and Reference to Installation Drawing
- Certificate # reference (ie. 2005 1632187 X)

#### Div. 2 Non-arcing models (.....B7x, EXHT and EXHTTO series)

- CSA Monogram with C US indicator.
- Submitter Identification
- Model Number
- Serial Number, Date Code or Month and Year of Manufacture
- Electrical Rating
- Hazardous Location Designation: As per Product Section
- Applicable Temperature Code
- Applicable Ambient temperature range
- For EXHT and EXHTTO series: DC symbol “    ”
- Certificate # reference (ie. 2005 1632187 X)
- Caution: re. Disconnection of circuits (appears on referenced Installation Drawing).

EXHT and EXHTTO series models must be accompanied by documentation containing the following information.

#### General:

Technical specifications, product operation, service and instructions for use.

#### Equipment Ratings:

This includes equipment supply, description of I/O connections, duty cycle and operating environmental conditions.

1. Pollution degree 4;
2. Electrical Ratings: 24VDC, 20mA
3. Temperature (ambient): -40°C to 121°C
4. Hazardous location ratings





## Supplement to Certificate of Compliance

Certificate: 1632187

Master Contract: 184981

*The products listed, including the latest revision described below, are eligible to be marked in accordance with the referenced Certificate.*

### Product Certification History

Project	Date	Description
80014642	2019-11-26	<p>Evaluation for update of report 1632187 (last update 70051763) to include High Temperature option.</p> <p>Quote assumes that maximum two versions of similar schematics are needed to be assessed. Quote includes one temperature test. Only the new model will be assessed with the latest applicable standards.</p> <p>Any other testing that may be required to accomplish the reassessment will be quoted separately if necessary.</p>
000070051763	2016-03-22	Update to Existing Report Certificate 1632187; Report 2655913. Expansion of the "x" and "y" variable digits.
0002655913	2013-09-26	Update to include new Model CS64xB9y Vibration Sensors.
0002108819	2008-11-26	Update to cover revisions to numerous drawings.
0001920106	2007-06-06	Update to cover minor revisions to circuitry and to related drawings.
0001878614	2007-01-31	Update to cover addition of models 9842VCRT and 9942VCRT.
0001632187	2005-11-03	640 Series Vibration Sensors for Hazardous Locations



# IECEX Certificate of Conformity

## INTERNATIONAL ELECTROTECHNICAL COMMISSION IEC Certification System for Explosive Atmospheres

for rules and details of the IECEx Scheme visit [www.iecex.com](http://www.iecex.com)

Certificate No.: **IECEX LCIE 17.0016X** Page 1 of 4 Certificate history:  
Status: **Current** Issue No: 1 Issue 0 (2018-07-11)  
Date of Issue: 2023-02-28  
Applicant: **PCB Piezotronics Inc.**  
3245 Walden Avenue  
Depew, New York 14043  
United States of America  
Equipment: **Vibration sensors – Type: EX(M)64\*\*\*\*/M\*\*, EXTO(M)64\*\*\*\*/M\*\*, EXRV(M)64\*\*\*\*/M\*\***  
Optional accessory:  
Type of Protection: **Ex ia ; Ex ec**  
Marking: Ex ia IIC T4 Ga  
Ex ec IIC T4 Gc  
*(refer to Annex for full marking)*

Approved for issue on behalf of the IECEx  
Certification Body:

**Julien GAUTHIER**

Position:

**Certification Officer**

Signature:  
(for printed version)



Date:  
(for printed version)

2023-02-28

1. This certificate and schedule may only be reproduced in full.
2. This certificate is not transferable and remains the property of the issuing body.
3. The Status and authenticity of this certificate may be verified by visiting [www.iecex.com](http://www.iecex.com) or use of this QR Code.



Certificate issued by:

**Laboratoire Central des Industries Electriques (LCIE)**  
33 Avenue du General Leclerc  
FR-92260 Fontenay-aux-Roses





# IECEX Certificate of Conformity

Certificate No.: **IECEX LCIE 17.0016X**

Page 2 of 4

Date of issue: 2023-02-28

Issue No: 1

Manufacturer: **PCB Piezotronics Inc.**  
3245 Walden Avenue  
Depew, New York 14043  
**United States of America**

Manufacturing locations: **PCB Piezotronics Inc.**  
3245 Walden Avenue  
Depew, New York 14043  
**United States of America**

This certificate is issued as verification that a sample(s), representative of production, was assessed and tested and found to comply with the IEC Standard list below and that the manufacturer's quality system, relating to the Ex products covered by this certificate, was assessed and found to comply with the IECEX Quality system requirements. This certificate is granted subject to the conditions as set out in IECEX Scheme Rules, IECEX 02 and Operational Documents as amended

#### STANDARDS :

The equipment and any acceptable variations to it specified in the schedule of this certificate and the identified documents, was found to comply with the following standards

**IEC 60079-0:2017** Explosive atmospheres - Part 0: Equipment - General requirements  
Edition:7.0

**IEC 60079-11:2011** Explosive atmospheres - Part 11: Equipment protection by intrinsic safety "i"  
Edition:6.0

**IEC 60079-7:2017** Explosive atmospheres - Part 7: Equipment protection by increased safety "e"  
Edition:5.1

This Certificate **does not** indicate compliance with safety and performance requirements other than those expressly included in the Standards listed above.

#### TEST & ASSESSMENT REPORTS:

A sample(s) of the equipment listed has successfully met the examination and test requirements as recorded in:

#### Test Reports:

FR/LCIE/ExTR17.0009/00  
US/ETL/ExTR22.0037/00

FR/LCIE/ExTR17.0041/00

FR/LCIE/ExTR22.0086/00

#### Quality Assessment Report:

NL/DEK/QAR14.0004/06



# IECEX Certificate of Conformity

Certificate No.: **IECEX LCIE 17.0016X**

Page 3 of 4

Date of issue: **2023-02-28**

Issue No: 1

## **EQUIPMENT:**

Equipment and systems covered by this Certificate are as follows:

These vibration sensors have a stainless steel housing comprising of electronics, completely encapsulated in potting compound, associated to a sensing element (piezoelectric crystal with a capacitance value  $\leq 700$  pF). The metallic enclosure of the sensor is a fully welded construction. The shape of the housing differs depending on the type of the equipment.

The sensors are fitted with an integral connector or an integral (unarmoured or armoured) cable. The maximum length of cable is 305 m. The electrical connection can also be done via a terminal block or flying leads depending on the type of the equipment. In this case, the vibration sensor is screwed, thanks to a 1 inch NPT external thread, into a Y-3 capped conduit elbow (100-7094-90) from Killark providing a degree of protection IP54.

The vibration sensors provide a 4-20mA current output when subjected to mechanical motion.

The products with TO (Temperature Output) option includes an additional independent 4-20mA output for temperature measurement. The imbedded temperature sensor monitors the environment internal to the sensor housing.

The products with RV option includes a 0-2.5 V a.c. and 2.5 V d.c. output that corresponds to raw vibration from the imbedded accelerometer.

**Range details:** Refer to the Annex

**Ratings:** Refer to the Annex

**SPECIFIC CONDITIONS OF USE: YES as shown below:**

Refer to the Annex for full Specific Conditions of Use.



# IECEX Certificate of Conformity

Certificate No.: **IECEX LCIE 17.0016X**

Page 4 of 4

Date of issue: 2023-02-28

Issue No: 1

## **DETAILS OF CERTIFICATE CHANGES (for issues 1 and above)**

### **Issue 1:**

- Normative update according to IEC 60079-0 Ed. 7.0 and IEC 60079-7 Ed. 5.1.
- Update of the Range details to introduce "modified" sensors (M) for customer special request (no impact on the types of protection).
- Update of the name of the applicant/manufactureur.
- Update of Specific Conditions of Use.

### **Annex:**

[Annex 01 to Certificate IECEx LCIE 17.0016X issue 1.pdf](#)



# Annex 01 to Certificate IECEx LCIE 17.0016X issue 1



## MARKING

### Complete marking:

PCB Piezotronics Inc. or IMI Sensors or IMI

Address: ...

Type: EX(M)64\*\*\*\*/M\*\* or EXTO(M)64\*\*\*\*/M\*\* or EXRV(M)64\*\*\*\*/M\*\* <sup>(1)</sup>

Serial number: ...

Year of construction: ...

Ex ia IIC T4 Ga

Ex ec IIC T4 Gc

-40 °C ≤ T<sub>amb</sub> ≤ +80 °C

IECEx LCIE 17.0016X

### For Intrinsic safety "ia" type of protection only:

Ui: ...V; li: ...mA; Pi: ...W; Ci: ...nF; Li: ...µH (related to the type, see Ratings section)

### For increased safety "ec" type of protection only:

WARNING – DO NOT CONNECT OR DISCONNECT WHEN ENERGIZED

### Reduced marking:

PCB Piezotronics Inc. or IMI Sensors or IMI

Type: EX(M)64\*\*\*\*/M\*\* or EXTO(M)64\*\*\*\*/M\*\* or EXRV(M)64\*\*\*\*/M\*\* <sup>(1)</sup>

Serial number: ...

Year of construction: ...

Ex ia IIC T4 Ga, T<sub>a</sub> = 80 °C

Ex ec IIC T4 Gc, T<sub>a</sub> = 80 °C

IECEx LCIE 17.0016X

<sup>(1)</sup> Completed as per the type

## RATINGS

### Intrinsic safety "ia" type of protection:

Type of the equipment	Configuration	IS electrical parameters				
		Ui (V)	li (mA)	Pi (W)	Ci (nF)	Li (µH)
EX(M)64**0**, EX(M)64**9**	with integral connector	30	100	1	0	121.1
EX(M)64**1**/M**, EX(M)64**6**/M**	with integral cable	30	100	1	61	426.1
EXTO(M)64**3**, EXTO(M)64**9**	with Temperature Output and connector	28	120	1	0	122.2
EXTO(M)64**1**/M**, EXTO(M)64**6**/M**	with Temperature Output and integral cable	28	120	1	61	427.2
EXRV(M)64**0**, EXRV(M)64**9**	with Raw Vibration Output and connector	28	120	1	25	121.1
EXRV(M)64**1**/M**, EXRV(M)64**6**/M**	with Raw Vibration Output and integral cable	28	120	1	80	426.1
EX(M)64**7**, EX(M)64**8**	with flying leads or terminal block + capped conduit elbow	30	100	1	0	121.1
EXRV(M)64**7**, EXRV(M)64**8**	with Raw Vibration Output and flying leads or terminal block + capped conduit elbow	30	120	1	25	121.1



# Annex 01 to Certificate IECEX LCIE 17.0016X issue 1



L C I E

**Increased safety “ec” type of protection:**

Maximum input voltage  $U_{max}$  : 30 V d.c.

Maximum power  $P_{max}$  : 1 W

**RANGE DETAILS**

EX	*	64	*	*	*	*	*	/	M	*	*	
<p style="text-align: right;">Optional Two characters to designate cable termination type</p> <p style="text-align: right;">Optional Three to six digits using xxx-xx to designate length in feet-inches or meters-centimeters with M in previous column</p> <p style="text-align: right;">Optional Metric Cable Length</p> <p style="text-align: right;">Optional Cable length modifier</p> <p>For M only; A number (01 to 999) which designates a special model number with custom sensitivity, measurement range, frequency range, cable length and cable termination. May include added customer Logo and model number in addition to PCB Model and Logo.</p> <p>A number or letter 0, 1, 2, 3, 4, 5, 6, 7, 8, 9, M which designates measurement range and filtering M = Customer special</p> <p>One number 0, 1, 3, 6, 7, 8 or 9 which denotes the type of connector:            0 = For 2-Pin MIL-C-5015 connector or 3-Pin MIL-C-5015 if RV option            1 = For Integral polyurethane jacketed cable            3 = For 4-Pin MIL-C-26482 connector for TO option            6 = Integral armoured polyurethane jacketed cable            7 = Terminal Block for conduit hub version sensor (with capped elbow)            8 = Flying Leads for conduit hub version sensor (with capped elbow)            9 = For M12 4/5-Pin connector</p> <p style="text-align: right;">One letter A to Z to denote model revision level</p> <p>One number 0, 1, 2, 3, 4, 5, 6, 7 or 8 which denotes the type of sensor and output measurement range:            0 = For Top-Exit or Conduit Hub configurations with measurement range in in/sec pk            1 = For Top-Exit or Conduit Hub configurations with measurement range in in/sec rms            2 = For Side-Exit configurations with measurement range in in/sec pk            3 = For Side-Exit configurations with measurement range in in/sec rms            4 = Reserved for future exit location and measurement range            5 = For Top-Exit or Conduit Hub configurations with measurement range of 0 to 5 g rms            6 = For Top-Exit or conduit Hub configurations with measurement range of 0 to 10 g rms            7 = For Side-Exit configurations with measurement range of 0 to 5 g rms            8 = For Side-Exit configurations with measurement range of 0 to 10 g rms</p> <p style="text-align: right;">64 Series Family of sensors</p> <p>One or more Sensor Options:            M = Metric Mount            TO = Temperature Output            RV = Raw Vibration Output</p> <p>Product Type :            EX = ATEX/IECEX Product</p>												



## Annex 01 to Certificate IECEX LCIE 17.0016X issue 1



### FULL CONDITIONS OF CERTIFICATION

#### *For all types of protection:*

- Ambient operating temperature range: -40 °C up to +80 °C.
- The mounting of the sensor into an installation must be carried out in such a way that sensor metallic body and cable shield are reliably connected to the system earth.
- The equipment must be connected according to the instruction manual of the manufacturer.

#### *Additionally specific condition(s) for intrinsic safety "ia" type of protection:*

- The intrinsically safe sensor shall only be connected to an associated intrinsically safe apparatus certified for the intended use. This association shall comply with the requirements of the standard IEC 60079-25.
- For sensor fitted with a capped conduit elbow: The user shall ensure that the capped elbow is not exposed to any risk of mechanical impact or friction.

#### *Additionally specific condition(s) for increased safety "ec" type of protection:*

- The sensor shall only be connected to an external power supply delivering a maximum of 30 V d.c. and 1 Watt.
- Transient protection shall be provided that is set at a level not exceeding 140 % of the peak rated voltage value at the supply terminals to the sensor.
- For sensors with integral connector: the mating connector provided by the end user shall be in accordance with all applicable clauses of IEC 60079-0 and IEC 60079-7 for a zone 2 application. A minimum degree of protection IP54 according to IEC 60079-0 shall be ensured.  
The mating connector shall not be connected or disconnected when energized.
- For sensors with flying leads: the flying leads shall be suitably protected from impact and shall be terminated within a suitably certified enclosure or in safe area. The installation shall guarantee that no pulling force will be applied to the leads.
- For sensors fitted with a capped conduit elbow:  
The user shall use an "Ex e" certified entry device at the capped elbow's entry while respecting the installation requirements of IEC 60079-14.  
Disconnect the equipment from supply circuit before opening the capped conduit elbow.  
The disassembling of the sensor from its capped elbow is not allowed.
- WARNING – DO NOT CONNECT OR DISCONNECT WHEN ENERGIZED

### ROUTINE TESTS

In accordance with clause 7.1 of standard IEC 60079-7, each product manufactured shall be subjected to a dielectric strength test at 500 V a.c. for 1 minute. Alternatively the test may be carried out at 600 V a.c. for 100 ms. No breakdown shall occur.





# IECEx Certificate of Conformity

## INTERNATIONAL ELECTROTECHNICAL COMMISSION IEC Certification Scheme for Explosive Atmospheres

for rules and details of the IECEx Scheme visit [www.iecex.com](http://www.iecex.com)

Certificate No.: IECEx LCIE 17.0016X Issue No: 0 Certificate history:  
Issue No. 0 (2018-07-11)

Status: **Current** Page 1 of 3

Date of Issue: **2018-07-11**

Applicant: **IMI, a division of PCB Piezotronics**  
3425 Walden Avenue  
DEPEW, NY 14043  
**United States of America**

Equipment: **Vibration Transmitter, Type: EX(M)64xYxx, EXTO(M)64xYxx, EXRV(M)64xYxx**  
*Optional accessory:*

Type of Protection: **Ex ia or Ex nA**

Marking:  
Ex ia IIC T4 Ga  
or  
Ex nA IIC T4 Gc  
(See attachment full marking)

Approved for issue on behalf of the IECEx  
Certification Body:

Julien GAUTHIER

Position:

Certification Officer

Signature:  
(for printed version)

Date:

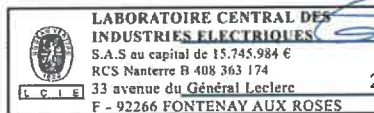

1. This certificate and schedule may only be reproduced in full.
2. This certificate is not transferable and remains the property of the issuing body.
3. The Status and authenticity of this certificate may be verified by visiting the Official IECEx Website.

Certificate issued by:

**Laboratoire Central des Industries Electriques (LCIE)**  
33 Avenue du General Leclerc  
FR-92260 Fontenay-aux-Roses  
France





# IECEX Certificate of Conformity

Certificate No: IECEx LCIE 17.0016X Issue No: 0  
Date of Issue: **2018-07-11** Page 2 of 3  
Manufacturer: **IMI, a division of PCB Piezotronics**  
3425 Walden Avenue  
DEPEW, NY 14043  
**United States of America**

Additional Manufacturing location(s):

This certificate is issued as verification that a sample(s), representative of production, was assessed and tested and found to comply with the IEC Standard list below and that the manufacturer's quality system, relating to the Ex products covered by this certificate, was assessed and found to comply with the IECEx Quality system requirements. This certificate is granted subject to the conditions as set out in IECEx Scheme Rules, IECEx 02 and Operational Documents as amended.

#### STANDARDS:

The apparatus and any acceptable variations to it specified in the schedule of this certificate and the identified documents, was found to comply with the following standards:

<b>IEC 60079-0 : 2011</b> Edition:6.0	Explosive atmospheres - Part 0: General requirements
<b>IEC 60079-11 : 2011</b> Edition:6.0	Explosive atmospheres - Part 11: Equipment protection by intrinsic safety "i"
<b>IEC 60079-15 : 2010</b> Edition:4	Explosive atmospheres - Part 15: Equipment protection by type of protection "n"

*This Certificate **does not** indicate compliance with electrical safety and performance requirements other than those expressly included in the Standards listed above.*

#### TEST & ASSESSMENT REPORTS:

*A sample(s) of the equipment listed has successfully met the examination and test requirements as recorded in*

#### Test Report:

FR/LCIE/ExTR17.0041/00 FR/LCIE/ExTR17.0009/00

#### Quality Assessment Report:

NL/DEK/QAR14.0004/03



# IECEX Certificate of Conformity

Certificate No: IECEx LCIE 17.0016X

Issue No: 0

Date of Issue: 2018-07-11

Page 3 of 3

## Schedule

### EQUIPMENT:

*Equipment and systems covered by this certificate are as follows:*

#### **Functional description:**

The apparatus is a vibration transmitter integrating a piezoelectric crystal, an electronic signal processing and a connector or a cable or flying leads for external interface. The delivered signal is an output current in the range 4-20mA corresponding to vibration level.

Apparatus, type EXTO, are provided with an integrated temperature sensor.

Apparatus, type EXRV, delivers raw vibration output in the range 0-2,5VAC.

#### **Mechanical description:**

Sensor heads are made of stainless steel housings with different shapes, depending on the type. External connections can be done by connector or shield cable (305 maximum length) or flying leads depending on the type (see drawings in the apparatus overview section).

(See attachment for full equipment description)

#### **SPECIFIC CONDITIONS OF USE: YES as shown below:**

##### **Specific conditions of use for Ex Ia and Ex nA protections:**

- Ambient temperature range: -40°C to +80°C
- The mounting of the apparatus into an installation must be carried out in such a way that sensor metallic body and cable shield are reliably connected to the system earth.
- The apparatus must be connected according to instruction manual.

##### **Specific condition of use for intrinsic safety Ex ia protection:**

The intrinsically safe apparatus shall only be connected to associated intrinsically safe apparatus certified for the intended use. This association shall comply with the requirements of the standard IEC 60079-25.

##### **Specific condition of use for non sparking Ex nA protection:**

- The equipment must only be connected to an external source with 30V maximum voltage and maximum power 1W.
- For final installation, the user shall take all necessary precautions to maintain the minimum degree of protection IP54 of the sensor connection when connected according to the requirements of IEC 60079-14 requirements.
- WARNING - DO NOT SEPARATE WHEN ENERGIZED.

### Annex:

LCIE 17.0016X - Issue 00 - Annex 01.pdf



# Annex 01 to Certificate IECEX LCIE 17.0016X issue 00



## MARKING

### Full marking :

PCB Piezotronics Inc. or IMI Sensors or IMI  
 Address: ...  
 Type: ...  
 Serial number: ...  
 Year of construction: ...  
 Ex ia IIC T4 Ga  
 Ex nA IIC T4 Gc  
 -40°C ≤ Tamb ≤ +80°C  
 IECEX LCIE 17.0016X

### For Intrinsic safety Ex ia protection only:

U<sub>i</sub>: ...V; I<sub>i</sub>: ...mA; P<sub>i</sub>: ...W; C<sub>i</sub>: ...nF; L<sub>i</sub>: ...µH (related to type, see ratings section)

### For nA protection only:

WARNING – DO NOT SEPARATE WHEN ENERGIZED

### Reduced marking :

PCB Piezotronics Inc. or IMI Sensors or IMI  
 Type: ...  
 Serial number: ...  
 Year of construction: ...  
 Ex ia IIC T4 Ga, Ta=80°C  
 Ex nA IIC T4 Gc, Ta=80°C  
 IECEX LCIE 17.0016X

## RANGE DETAILS

### List of types references:

- EX(M)64xA0y, EX(M)64xB0y with connector.
- EX(M)64xA1y, EX(M)64xA6y, EX(M)64xB1y, EX(M)64xB6y with cable.
- EXTO(M)64xA3y, EXTO(M)64xB3y with temperature sensor and connector.
- EXTO(M)64xA1y, EXTO(M)64xA6y, EXTO(M)64xB1y, EXTO(M)64xB6y with temperature sensor and cable.
- EXRV(M)64xA0y, EXRV(M)64xB0y with raw vibration output and connector.
- EXRV(M)64xA1y, EXRV(M)64xA6y, EXRV(M)64xB1y, EXRV(M)64xB6y with raw vibration output and cable.
- EX(M)64xB7y with flying leads.
- EXTO(M)64xB7y, with temperature sensor and flying leads.
- EXRV(M)64xB7y, with raw vibration output and flying leads.

M indicates apparatus in Metric version.

Letters x and y are variable digits of the type (values between 0 and 9).

## RATINGS

### Intrinsic safety Ex ia protection:

Apparatus Types	IS parameters
EX(M)64xA0y, EX(M)64xB0y .....	U <sub>i</sub> : 30V; I <sub>i</sub> : 100mA; P <sub>i</sub> : 1W; C <sub>i</sub> : 0nF; L <sub>i</sub> : 121.1µH
EX(M)64xA1y, EX(M)64xA6y, EX(M)64xB1y, EX(M)64xB6y .....	U <sub>i</sub> : 30V; I <sub>i</sub> : 100mA; P <sub>i</sub> : 1W; C <sub>i</sub> : 61nF; L <sub>i</sub> : 426.1µH
EXTO(M)64xA3y, EXTO(M)64xB3y .....	U <sub>i</sub> : 28V; I <sub>i</sub> : 120mA; P <sub>i</sub> : 1W; C <sub>i</sub> : 0nF; L <sub>i</sub> : 122.2µH
EXTO(M)64xA1y, EXTO(M)64xA6y, EXTO(M)64xB1y, EXTO(M)64xB6y ....	U <sub>i</sub> : 28V; I <sub>i</sub> : 120mA; P <sub>i</sub> : 1W; C <sub>i</sub> : 61nF; L <sub>i</sub> : 427.2µH
EXRV(M)64xA0y, EXRV(M)64xB0y .....	U <sub>i</sub> : 28V; I <sub>i</sub> : 120mA; P <sub>i</sub> : 1W; C <sub>i</sub> : 25nF; L <sub>i</sub> : 121.1µH
EXRV(M)64xA1y, EXRV(M)64xA6y, EXRV(M)64xB1y, EXRV(M)64xB6y ...	U <sub>i</sub> : 28V; I <sub>i</sub> : 120mA; P <sub>i</sub> : 1W; C <sub>i</sub> : 80nF; L <sub>i</sub> : 426.1µH
EX(M)64xB7y .....	U <sub>i</sub> : 30V; I <sub>i</sub> : 100mA; P <sub>i</sub> : 1W; C <sub>i</sub> : 0nF; L <sub>i</sub> : 121.1µH
EXTO(M)64xB7y .....	U <sub>i</sub> : 30V; I <sub>i</sub> : 120mA; P <sub>i</sub> : 1W; C <sub>i</sub> : 0nF; L <sub>i</sub> : 122.2µH
EXRV(M)64xB7y .....	U <sub>i</sub> : 30V; I <sub>i</sub> : 120mA; P <sub>i</sub> : 1W; C <sub>i</sub> : 25nF; L <sub>i</sub> : 121.1µH

### Non sparking Ex nA protection:

Maximum input voltage U<sub>max</sub> : 30V  
 Maximum power P<sub>max</sub> : 1W

## ROUTINE TESTS

**Intrinsic safety Ex ia protection:**

None.

**Non sparking Ex nA protection:**

Each equipment shall be submitted to the dielectric strength test according to the clause 23.2.1 of IEC 60079-15:2010. Test voltage shall be applied between active electrical signals and the enclosure.

## APPARATUS OVERVIEW

Mechanical constructions of the apparatus, head shapes and external connection possibilities:

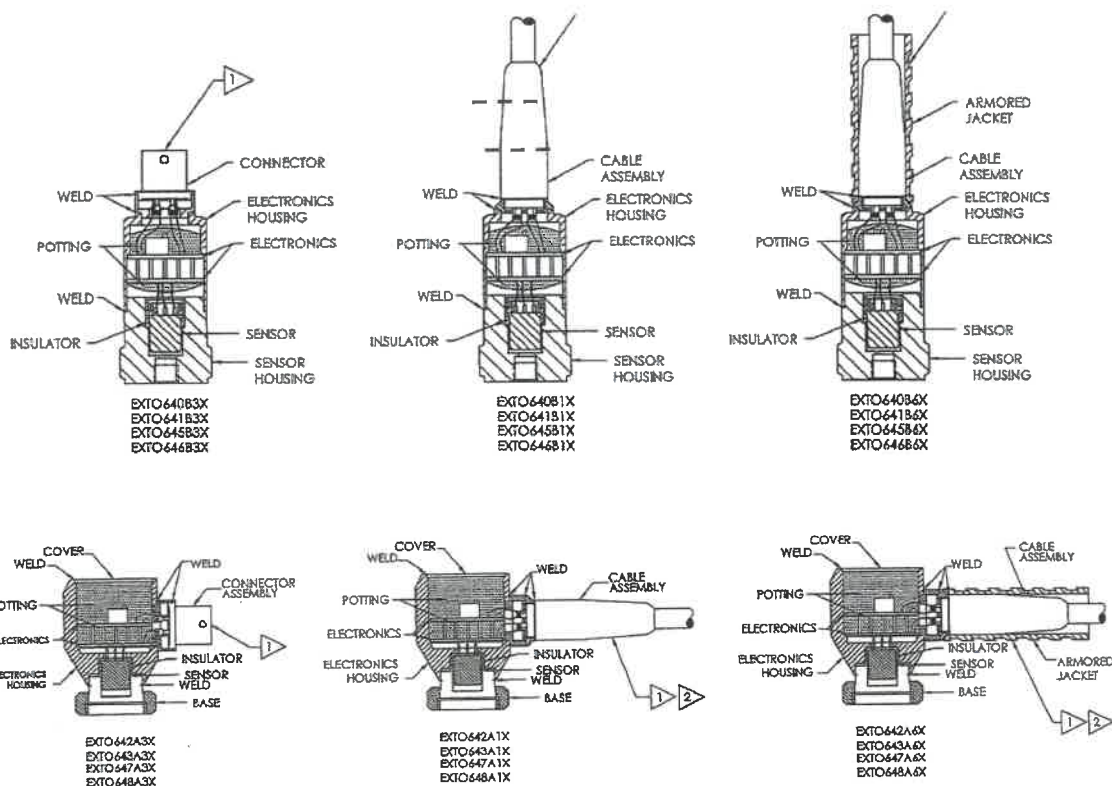



# ATTESTATION D'EXAMEN DE TYPE

## TYPE EXAMINATION CERTIFICATE



1 Version : 03

**LCIE 05 ATEX 6155 X**

Issue : 03

- |   |  |
|---|--|
| <p>2 <b>Directive 2014/34/UE</b><br/>Appareil ou Système de Protection destiné à être utilisé en Atmosphères Explosibles</p> <p>3 <b>Produit :</b><br/>Capteurs de vibration</p> <p>4 <b>Fabricant :</b></p> <p>5 <b>Adresse :</b></p> <p>6 Ce produit et ses variantes éventuelles acceptées sont décrits dans l'annexe de la présente attestation et dans les documents descriptifs cités en référence.</p> <p>7 Le LCIE certifie que ce produit est conforme aux Exigences Essentielles de Sécurité et de Santé pour la conception et la construction de produits destinés à être utilisés en atmosphères explosibles, données dans l'annexe II de la Directive.<br/>Les résultats des vérifications et essais figurent dans le(s) rapport(s) confidentiel(s) N° :</p> <p>8 Le respect des Exigences Essentielles de Sécurité et de Santé est assuré par la conformité à :</p> <p>9 Le signe « X » lorsqu'il est placé à la suite du numéro de l'attestation, indique que cet appareil est soumis aux conditions particulières d'utilisation, mentionnées dans l'annexe de cette attestation.</p> <p>10 Cette Attestation d'Examen de Type concerne uniquement la conception et la construction du produit spécifié.<br/>Des exigences supplémentaires de la directive sont applicables pour la fabrication et la fourniture du produit. Ces dernières ne sont pas couvertes par la présente attestation.</p> <p>11 Le marquage du produit est mentionné dans l'annexe de cette attestation.</p> | <p><b>Directive 2014/34/EU</b><br/>Equipment or Protective System Intended for use in Potentially Explosive Atmospheres</p> <p><b>Product :</b><br/>Vibration sensors</p> <p><b>Manufacturer :</b><br/>PCB Piezotronics Inc.</p> <p><b>Address :</b><br/>3425 Walden Avenue<br/>Depew, New York 14043<br/>États-Unis d'Amérique</p> <p>This product and any acceptable variation thereto are specified in the schedule to this certificate and the documents therein referred to.</p> <p>LCIE certifies that product has been found to comply with the Essential Health and Safety Requirements relating to the design and construction of products intended for use in potentially explosive atmospheres, given in Annex II to the Directive.<br/>The examination and test results are recorded in confidential report(s) N°:<br/>140596-682759 ; 162903-740871</p> <p>Compliance with the Essential Health and Safety Requirements has been assured by compliance with :<br/>EN IEC 60079-0:2018<br/>EN 60079-7:2015 + A1:2018</p> <p>If the sign "X" is placed after the certificate number, it indicates that the product is subject to the Specific Conditions of Use specified in the schedule to this certificate.</p> <p>This Type Examination Certificate relates only to the design and construction of the specified product.<br/>Further requirements of the Directive apply to the manufacturing process and supply of this product. These are not covered by this certificate.</p> <p>The marking of the product is specified in the schedule to this certificate.</p> |
|---|--|

Fontenay-aux-Roses, le 28 février 2023

Responsable de Certification



Certification Officer  
Julien Gauthier

#### 12 DESCRIPTION DU PRODUIT

Ces capteurs de vibration ont un boîtier en acier inoxydable intégrant une électronique, complètement encapsulée dans un composé d'empotage, associée à un élément sensible (cristal piézoélectrique avec une valeur de capacité  $\leq 700$  pF).

La construction du boîtier métallique du capteur est entièrement soudée. La forme du boîtier diffère selon le modèle du capteur.

Les capteurs sont équipés d'un connecteur intégré ou d'un câble intégré (non armé ou armé). La longueur maximale du câble est de 305 m.

Le raccordement électrique peut également se faire via un bornier ou des conducteurs volants selon le modèle de capteur. Dans ce cas, le capteur de vibration est vissé, grâce à un filetage externe 1" NPT, dans un coude de conduit Y-3 (100-7094-90) de Killark procurant un degré de protection IP54.

Les capteurs de vibration fournissent en sortie un courant de 4-20 mA lorsqu'ils sont soumis à un mouvement mécanique.

Les produits avec option TO incluent une sortie 4-20mA supplémentaire indépendante pour la mesure de la température. Le capteur de température intégré surveille l'environnement interne au boîtier du capteur.

Les produits avec option RV fournissent en sortie une tension de 0-2,5 V c.a. et 2,5 V c.c. correspondant à la vibration brute de l'accéléromètre intégré.

#### DESCRIPTION OF PRODUCT

These vibration sensors have a stainless steel housing comprising of electronics, completely encapsulated in potting compound, associated to a sensing element (piezoelectric crystal with a capacitance value  $\leq 700$  pF).

The metallic enclosure of the sensor is a fully welded construction. The shape of the housing differs depending on the model of the sensor.

The sensors are fitted with an integral connector or an integral (unarmoured or armoured) cable. The maximum length of cable is 305 m.

The electrical connection can also be done via a terminal block or flying leads depending on the type of the equipment. In this case, the vibration sensor is screwed, thanks to a 1 inch NPT external thread, into a Y-3 capped conduit elbow (100-7094-90) from Killark providing a degree of protection IP54.

The vibration sensors provide a 4-20mA current output when subjected to mechanical motion.

The products with TO (Temperature Output) option includes an additional independent 4-20mA output for temperature measurement. The imbedded temperature sensor monitors the environment internal to the sensor housing.

The products with RV option include a 0-2.5 V a.c. and 2.5 V d.c. output that corresponds to raw vibration from the imbedded accelerometer.

Type de l'équipement <i>Type of the equipment</i>	Configuration
EX(M)64**0**, EX(M)64**9**	Avec connecteur intégré <i>with integral connector</i>
EX(M)64**1**/M**, EX(M)64**6**/M**	Avec câble intégré <i>with integral cable</i>
EXTO(M)64**3**, EXTO(M)64**9**	Avec sortie température et connecteur <i>with Temperature Output and connector</i>
EXTO(M)64**1**/M**, EXTO(M)64**6**/M**	Avec sortie température et câble intégré <i>with Temperature Output and integral cable</i>
EXRV(M)64**0**, EXRV(M)64**9**	Avec sortie vibration brute et connecteur <i>with Raw Vibration Output and connector</i>
EXRV(M)64**1**/M**, EXRV(M)64**6**/M**	Avec sortie vibration brute et câble intégré <i>with Raw Vibration Output and integral cable</i>
EX(M)64**7**, EX(M)64**8**	Avec conducteurs volants ou bornier + coude de conduit <i>with flying leads or terminal block + capped conduit elbow</i>
EXRV(M)64**7** EXRV(M)64**8**	Avec sortie vibration brute et conducteurs volants ou bornier + coude de conduit <i>with Raw Vibration Output and flying leads or terminal block + capped conduit elbow</i>

#### CARACTERISTIQUES

Tension maximum d'entrée  $U_{max}$  : 30 V d.c.

Puissance maximale  $P_{max}$  : 1 W

#### RATINGS

Maximum input voltage  $U_{max}$  : 30 V d.c.

Maximum power  $P_{max}$  : 1 W

**DETAIL DE LA GAMME**

**RANGE DETAILS**

EX	*	64	*	*	*	*	*	/	M	*	*	
<p>Deux caractères optionnels pour désigner le type de terminaison du câble</p> <p>Trois à six chiffres optionnels utilisant xxx-xx pour désigner la longueur en pieds-pouces ou mètres-centimètres avec M dans la colonne précédente</p> <p>Longueur de câble métrique en option</p> <p>Modificateur de longueur de câble en option</p> <p>Pour M uniquement ; Un nombre (01 à 999) qui désigne un numéro de modèle spécial avec une sensibilité, une plage de mesure, une plage de fréquence, une longueur de câble et une terminaison de câble personnalisés. Peut inclure d'ajouter le logo du client et le numéro de modèle en plus du modèle et du logo PCB.</p> <p>Un chiffre ou une lettre 0, 1, 2, 3, 4, 5, 6, 7, 8, 9, M qui désigne la plage de mesure et le filtrage M = Spécial client</p> <p>Un chiffre 0, 1, 3, 6, 7, 8 ou 9 qui désigne le type de connecteur            0 = Pour connecteur MIL-C-5015 à 2 broches ou MIL-C-5015 à 3 broches si option RV            1 = Pour câble intégral gainé en polyuréthane            3 = Pour connecteur MIL-C-26482 à 4 broches pour option TO            6 = Câble intégral armé gainé en polyuréthane            7 = Bornier pour capteur version coude coiffé de conduit            8 = Conducteurs volants pour capteur version coude coiffé de conduit            9 = Pour connecteur M12 4/5 broches</p> <p>Une lettre de A à Z pour indiquer le niveau de révision du modèle</p> <p>Un chiffre 0, 1, 2, 3, 4, 5, 6, 7 ou 8 qui indique le type de capteur et la plage de mesure de sortie            0 = Pour les configurations Sortie par le haut ou Coude de conduit avec plage de mesure en in/sec crête            1 = Pour les configurations Sortie par le haut ou Coude de conduit avec plage de mesure en in/sec valeur efficace            2 = Pour les configurations Sortie sur le côté avec plage de mesure en in/sec crête            3 = Pour les configurations Sortie sur le côté avec plage de mesure en in/sec valeur efficace            4 = Réserve pour un futur emplacement de sortie et plage de mesure            5 = Pour les configurations Sortie par le haut ou Coude de conduit avec plage de mesure de 0 à 5 g valeur efficace            6 = Pour les configurations Sortie par le haut ou Coude de conduit avec plage de mesure de 0 à 10 g valeur efficace            7 = Pour les configurations Sortie sur le côté avec plage de mesure de 0 à 5 g valeur efficace            8 = Pour les configurations Sortie sur le côté avec plage de mesure de 0 à 10 g valeur efficace</p> <p>Famille de capteurs de la série 64</p> <p>Une ou plusieurs options de capteur            M = Monture métrique            TO = Sortie Température            RV = Sortie Vibration brute</p> <p>Type de produit :            EX = ATEX/IECEx Produit</p>												





# ATTESTATION D'EXAMEN DE TYPE - ANNEXE

## TYPE EXAMINATION CERTIFICATE - SCHEDULE

1 Version : 03

### LCIE 05 ATEX 6155 X

Issue : 03

EX	*	64	*	*	*	*	*	/	M	*	*	
<p style="margin-left: 40px;">Optional Two characters to designate cable termination type</p> <p style="margin-left: 40px;">Optional Three to six digits using xxx-xx to designate length in feet-inches or meters-centimeters with M in previous column</p> <p style="margin-left: 40px;">Optional Metric Cable Length</p> <p style="margin-left: 40px;">Optional Cable length modifier</p> <p style="margin-left: 40px;">For M only; A number (01 to 999) which designates a special model number with custom sensitivity, measurement range, frequency range, cable length and cable termination. May include added customer Logo and model number in addition to PCB Model and Logo.</p> <p style="margin-left: 40px;">A number or letter 0, 1, 2, 3, 4, 5, 6, 7, 8, 9, M which designates measurement range and filtering M = Customer special</p> <p style="margin-left: 40px;">One number 0, 1, 3, 6, 7, 8 or 9 which denotes the type of connector:            0 = For 2-Pin MIL-C-5015 connector or 3-Pin MIL-C-5015 if RV option            1 = For Integral polyurethane jacketed cable            3 = For 4-Pin MIL-C-26482 connector for TO option            6 = Integral armoured polyurethane jacketed cable            7 = Terminal Block for conduit hub version sensor (with capped elbow)            8 = Flying Leads for conduit hub version sensor (with capped elbow)            9 = For M12 4/5-Pin connector</p> <p style="margin-left: 40px;">One letter A to Z to denote model revision level</p> <p style="margin-left: 40px;">One number 0, 1, 2, 3, 4, 5, 6, 7 or 8 which denotes the type of sensor and output measurement range:            0 = For Top-Exit or Conduit Hub configurations with measurement range in in/sec pk            1 = For Top-Exit or Conduit Hub configurations with measurement range in in/sec rms            2 = For Side-Exit configurations with measurement range in in/sec pk            3 = For Side-Exit configurations with measurement range in in/sec rms            4 = Reserved for future exit location and measurement range            5 = For Top-Exit or Conduit Hub configurations with measurement range of 0 to 5 g rms            6 = For Top-Exit or conduit Hub configurations with measurement range of 0 to 10 g rms            7 = For Side-Exit configurations with measurement range of 0 to 5 g rms            8 = For Side-Exit configurations with measurement range of 0 to 10 g rms</p> <p style="margin-left: 40px;">64 Series Family of sensors</p> <p style="margin-left: 40px;">One or more Sensor Options:            M = Metric Mount            TO = Temperature Output            RV = Raw Vibration Output</p> <p style="margin-left: 40px;">Product Type :            EX = ATEX/IECEX Product</p>												

**MARQUAGE**

Le marquage du produit doit comprendre :

Marquage complet :

PCB Piezotronics Inc. ou IMI Sensors ou IMI

Adresse : ...

Type : ... <sup>(1)</sup>

Numéro de fabrication : ...

Année de fabrication : ...

 Ex II 3 G

Ex ec IIC T4 Gc

LCIE 05 ATEX 6155 X

$-40\text{ °C} \leq T_{\text{amb}} \leq +80\text{ °C}$

**AVERTISSEMENT – NE PAS CONNECTER OU DECONNECTER SOUS TENSION**

Marquage réduit :

PCB Piezotronics Inc. ou IMI Sensors ou IMI

Type : ... <sup>(1)</sup>

N° de fabrication : ...

Année de fabrication : ...

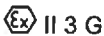
 Ex II 3 G

Ex ec IIC T4 Gc

$T_a = 80\text{ °C}$

LCIE 05 ATEX 6155 X

<sup>(1)</sup> Voir le détail de la gamme ci-dessus

L'appareil doit également comporter le marquage normalement prévu par les normes de construction qui le concernent sous la responsabilité du fabricant.

**13 CONDITIONS PARTICULIERES D'UTILISATION**

- Gamme de température ambiante de fonctionnement :  
 $-40\text{ °C}$  à  $+80\text{ °C}$ .
- L'appareil doit uniquement être connecté à une source externe délivrant au maximum une tension de 30 V d.c. et une puissance de 1 Watt.
- La protection contre les transitoires doit être fournie à un niveau défini ne dépassant pas 140 % de la valeur de crête de la tension assignée aux bornes d'alimentation vers l'appareil.
- Le montage du capteur dans une installation doit être effectué de telle sorte que le corps métallique du capteur et le blindage du câble soient reliés de manière fiable à la terre du système.

**MARKING**

The marking of the product shall include the following :

Full marking:

PCB Piezotronics Inc. or IMI Sensors or IMI

Address : ...

Type : ... <sup>(1)</sup>

Serial number : ...

Year of construction : ...

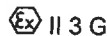
 Ex II 3 G

Ex ec IIC T4 Gc

LCIE 05 ATEX 6155 X

$-40\text{ °C} \leq T_{\text{amb}} \leq +80\text{ °C}$

**WARNING – DO NOT CONNECT OR DISCONNECT WHEN ENERGIZED**

Reduced marking:

PCB Piezotronics Inc. or IMI Sensors or IMI

Type : ... <sup>(1)</sup>

Serial number : ...

Year of construction : ...

 Ex II 3 G

Ex ec IIC T4 Gc

$T_a = 80\text{ °C}$

LCIE 05 ATEX 6155 X

<sup>(1)</sup> See the Range Details above

The equipment shall also bear the usual marking required by the product standards applying to such equipment under the manufacturer responsibility.

**SPECIFIC CONDITIONS OF USE**

Ambient operating temperature range:  
 $-40\text{ °C}$  up to  $+80\text{ °C}$ .

The transducer shall be connected to an external power supply delivering a maximum of 30 V d.c. and 1 W.

Transient protection shall be provided that is set at a level not exceeding 140 % of the peak rated voltage value at the supply terminals to the device.

The mounting of the sensor in an installation must be carried out in such a way that the sensor metallic body and cable shield are reliably connected to the system earth.

1 Version : 03

### LCIE 05 ATEX 6155 X

Issue : 03

- e. Pour les capteurs avec connecteur intégré :  
Le connecteur mâle ou femelle homologue fourni par l'utilisateur final doit être conforme à toutes les clauses applicables des normes EN 60079-0 et EN 60079-7. Un degré de protection IP54 minimum selon la norme IEC 60079-0 doit être assuré.  
Le connecteur homologue ne doit pas être connecté ou déconnecté sous tension.
- f. Pour les capteurs avec conducteurs volants :  
Les conducteurs volants doivent être convenablement protégés contre les chocs et doivent être connectés dans une enveloppe dûment certifiée ou dans une zone sûre. L'installation doit garantir qu'aucune force de traction ne sera appliquée aux conducteurs.
- g. Pour les capteurs avec coude de conduit:  
L'utilisateur devra utiliser un dispositif d'entrée certifié « Ex e » à l'entrée du coude tout en respectant les exigences d'installation de la norme EN 60079-14.  
Déconnecter le capteur du circuit d'alimentation avant d'ouvrir le coude de conduit.  
Le démontage du capteur de son coude de conduit n'est pas autorisé.
- h. **AVERTISSEMENT – NE PAS CONNECTER OU DECONNECTER SOUS TENSION**
- i. L'équipement doit être connecté conformément aux instructions du fabricant.

For sensor with integral connector:

The mating connector provided by the end user shall be in accordance with all applicable clauses of EN 60079-0 and EN 60079-7 for a zone 2 application. A minimum degree of protection IP54 according to EN 60079-0 shall be ensured.

The mating connector shall not be connected or disconnected when energized.

For sensors with flying leads:

The flying leads shall be suitably protected from impact and shall be terminated within a suitably certified enclosure or in safe area. The installation shall guarantee that no pulling force will be applied to the leads.

For sensors fitted with a capped conduit elbow:

The user shall use an "Ex e" certified entry device at the capped elbow's entry while respecting the installation requirements of EN 60079-14.

Disconnect the device from supply circuit before opening the capped conduit elbow.

The disassembling of the sensor from its capped elbow is not allowed.

**WARNING – DO NOT CONNECT OR DISCONNECT WHEN ENERGIZED**

The equipment must be connected according to the instructions of the manufacturer.

#### 14 EXIGENCES ESSENTIELLES DE SANTE ET DE SECURITE

Couvertes par les normes listées au point 8.

#### ESSENTIAL HEALTH AND SAFETY REQUIREMENTS

Covered by standards listed at 8.

#### 15 DOCUMENTS DESCRIPTIFS

N°	Description	Reference	Rev.	Date	Page(s)
1.	Technical file	64777	A	2023-01-26	49
2.	Instructions For Use	32836	--	--	--

#### DESCRIPTIVE DOCUMENTS

#### 16 INFORMATIONS COMPLEMENTAIRES

##### Essais individuels

Conformément au paragraphe 7.1 de la norme EN 60079-7, chaque produit fabriqué doit être soumis à un essai de rigidité diélectrique à 500 V c.a. pendant 1 minute. Alternativement, le test peut être effectué à 600 V c.a. pendant 100 ms. Aucun claquage ne doit se produire.

#### ADDITIONAL INFORMATION

##### Routine tests

In accordance with clause 7.1 of standard EN 60079-7, each product manufactured shall be subjected to a dielectric strength test at 500 V a.c. for 1 minute. Alternatively the test may be carried out at 600 V a.c. for 100 ms. No breakdown shall occur.

#### 17 DETAILS DES MODIFICATIONS DE L'ATTESTATION

Version 00 : Version initiale.  
2005-12-07

#### DETAILS OF CERTIFICATE CHANGES

Issue 00: Initial issue.

1 Version : 03

**LCIE 05 ATEX 6155 X**

Issue : 03

- |   |   |  |  |
|---|---|--|--|
| <p>Version 01 :<br/>2007-08-02</p> <p>Version 02 :<br/>2018-07-11</p> <p>Version 03 :</p> | <ul style="list-style-type: none"><li>• Mise à jour normative selon les normes EN 60079-0:2006 et EN 60079-15:2005.</li><li>• Mise à jour normative selon les normes EN 60079-0:2012 + A11:2013 et EN 60079-15:2010.</li><li>• Distinction entre le nom du fabricant (PCB Piezotronics Inc.) et le nom de la marque commerciale (IMI Sensors ou IMI).</li><li>• Mise à jour de la nomenclature des modèles.</li><li>• Mise à jour normative selon les normes EN IEC 60079-0:2018 et EN 60079-7:2015 + A1:2018.</li><li>• Mise à jour de la désignation du type pour notamment introduire les capteurs « Modifiés » (M) sur demande spéciale du client (aucun impact sur les modes de protection).</li><li>• Mise à jour des conditions particulières d'utilisation.</li></ul> | <p>Issue 01:</p> <p>Issue 02:</p> <p>Issue 03:</p> | <ul style="list-style-type: none"><li>• Normative update according to EN 60079-0:2006 and EN 60079-15:2005 standards.</li><li>• Normative update according to EN 60079-0:2012+A11:2013 and EN 60079-15:2010 standards.</li><li>• Distinction between the name of the manufacturer (PCB Piezotronics Inc.) and the trademark (IMI Sensors or IMI).</li><li>• Update of the nomenclature of the models.</li><li>• Normative update according to EN IEC 60079-0:2018 and EN 60079-7:2015 + A1:2018.</li><li>• Update of the type designation to notably introduce "Modified" sensors (M) for customer special request (no impact on the types of protection).</li><li>• Update of Specific Conditions of Use.</li></ul> |
|---|---|--|--|



# ATTESTATION D'EXAMEN UE DE TYPE

## EU TYPE EXAMINATION CERTIFICATE



1 Version : 02

**LCIE 05 ATEX 6154 X**

Issue : 02

- |    |  |  |
|----|--|--|
| 2  | Directive 2014/34/UE<br>Appareil ou Système de Protection destiné à être utilisé en Atmosphères Explosibles  | Directive 2014/34/EU<br>Equipment or Protective System Intended for use in Potentially Explosive Atmospheres   |
| 3  | Produit :<br><b>Transmetteurs de vibration</b>   | Product :<br><b>Vibration transmitters</b>   |
|    | Type: EX(M)64xYxx, EXTO(M)64xYxx, EXRV(M)64xYxx  |  |
| 4  | Fabricant :  | Manufacturer :   |
| 5  | Adresse :  | Address :  |
|    | PCB Piezotronics Inc.<br>3425 Walden Avenue<br>DEPEW, NY 14043<br>UNITED STATES of AMERICA   |  |
| 6  | Ce produit et ses variantes éventuelles acceptées sont décrits dans l'annexe de la présente attestation et dans les documents descriptifs cités en référence.  | This product any acceptable variation thereto is specified in the schedule to this certificate and the documents therein referred to.  |
| 7  | Le LCIE, Organisme Notifié sous la référence 0081 conformément à l'article 17 de la directive 2014/34/UE du Parlement européen et du Conseil du 26 février 2014, certifie que ce produit est conforme aux Exigences Essentielles de Sécurité et de Santé pour la conception et la construction de produits destinés à être utilisés en atmosphères explosibles, données dans l'annexe II de la Directive.<br>Les résultats des vérifications et essais figurent dans le(s) rapport(s) confidentiel(s) N° : | LCIE, Notified Body number 0081 in accordance with article 17 of the Directive 2014/34/EU of the European Parliament and the Council of 26 February 2014 certifies that product has been found to comply with the Essential Health and Safety Requirements relating to the design and construction of products intended for use in potentially explosive atmospheres, given in Annex II to the Directive.<br>The examination and test results are recorded in confidential report(s) N°: |
|    | 140596-682756  |  |
| 8  | Le respect des Exigences Essentielles de Sécurité et de Santé est assuré par la conformité à :   | Compliance with the Essential Health and Safety Requirements has been assured by compliance with :   |
|    | EN 60079-0:2012+A11:2013,<br>EN 60079-11:2012  |  |
| 9  | Le signe « X » lorsqu'il est placé à la suite du numéro de l'attestation, indique que cet appareil est soumis aux conditions particulières d'utilisation, mentionnées dans l'annexe de cette attestation.  | If the sign "X" is placed after the certificate number, it indicates that the product is subject to the Specific Conditions of Use specified in the schedule to this certificate.  |
| 10 | Cette Attestation d'Examen UE de Type concerne uniquement la conception et la construction du produit spécifié. Des exigences supplémentaires de la directive sont applicables pour la fabrication et la fourniture du produit. Ces dernières ne sont pas couvertes par la présente attestation.   | This EU Type Examination Certificate relates only to the design and construction of the specified product. Further requirements of the Directive apply to the manufacturing process and supply of this product. These are not covered by this certificate.   |
| 11 | Le marquage du produit est mentionné dans l'annexe de cette attestation.   | The marking of the product is specified in the schedule to this certificate.   |

Fontenay-aux-Roses, le 11 juillet 2018

Responsable de Certification

Certification Officer

Julien Gauthier

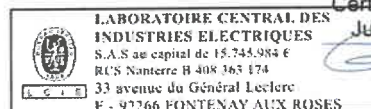

Seul le texte en français peut engager la responsabilité du LCIE. Ce document ne peut être reproduit que dans son intégralité, sans aucune modification. Il est établi en accord avec le référentiel de certification ATEX du LCIE. The LCIE's liability applies only on the French text. This document may only be reproduced in its entirety and without any change. It is issued in accordance with LCIE's ATEX Certification Rules.  
CERT-ATEX-FORM 04 Rev. 02

Page 1 of 4

LCIE

Laboratoire Central des Industries Electriques  
Une société de Bureau Veritas

33 Avenue du Général Leclerc  
92260 Fontenay-aux-Roses  
FRANCE

WWW.LCIE.FR

#### 12 DESCRIPTION DU PRODUIT

L'appareil est un transmetteur de vibration intégrant un cristal piézoélectrique, un traitement électronique du signal et un connecteur ou un câble intégré ou des fils volants pour l'interface externe. Le signal délivré est un courant de sortie dans la plage 4-20mA correspondant au niveau de vibration. Les appareils de type EXTO sont équipés d'un capteur de température intégré. L'appareil, type EXRV, délivre une sortie de vibration brute dans la plage 0-2.5VAC

Les boîtiers des têtes de capteur sont réalisés en acier inoxydable de plusieurs formes, en fonction du type. Les connexions externes peuvent être effectuées par connecteur ou câble blindé (305 m de longueur maximum) ou fils volants selon le type.

Equipement disponible en version métrique (type avec M)

#### DESCRIPTION OF PRODUCT

The apparatus is a vibration transmitter integrating a piezoelectric crystal, an electronic signal processing and a connector or a cable or flying leads for external interface. The delivered signal is an output current in the range 4-20mA corresponding to vibration level.

Apparatus, type EXTO, are provided with an integrated temperature sensor. Apparatus, type EXRV, delivers raw vibration output in the range 0-2.5VAC

Sensor heads are made of stainless steel housings with different shapes, depending on the type. External connections can be done by connector or shield cable (305m maximum length) or flying leads depending on the type.

Apparatus is available in metric version (type with M).

#### DETAIL DE LA GAMME

#### RANGE DETAILS

#### Types et caractéristiques / Types and characteristics

EX(M)64xA0y, EX(M)64xB0y avec connecteur / with connector.  
 EX(M)64xA1y, EX(M)64xA6y, EX(M)64xB1y, EX(M)64xB6y avec câble / with cable.  
 EXTO(M)64xA3y, EXTO(M)64xB3y avec capteur de température et connecteur / with temperature sensor and connector.  
 EXTO(M)64xA1y, EXTO(M)64xA6y, EXTO(M)64xB1y, EXTO(M)64xB6y avec capteur de température et câble / with temperature sensor and cable.  
 EXRV(M)64xA0y, EXRV(M)64xB0y avec sortie vibration brute et connecteur / with raw vibration output and connector.  
 EXRV(M)64xA1y, EXRV(M)64xA6y, EXRV(M)64xB1y, EXRV(M)64xB6y avec sortie vibration brute et câble / with raw vibration output and cable.  
 EX(M)64xB7y avec fils volants / with flying leads.  
 EXTO(M)64xB7y avec capteur de température et fils volants / with temperature sensor and flying leads.  
 EXRV(M)64xB7y avec sortie vibration brute et fils volants / with raw vibration output and flying leads.  
 Note: la lettre M indique un équipement en version métrique. Les lettres x et y sont des variables du type (valeurs de 0 à 9).  
 Note: M letter indicates apparatus in metric version. Letters x and y are variable digits of the type (values between 0 and 9).

#### Paramètres électriques :

#### Electrical parameters :

Type / Type	Paramètres de SI / IS parameters
EX(M)64xA0y, EX(M)64xB0y	U <sub>i</sub> : 30V; I <sub>i</sub> : 100mA; P <sub>i</sub> : 1W; C <sub>i</sub> : 0nF; L <sub>i</sub> : 121.1µH
EX(M)64xA1y, EX(M)64xA6y, EX(M)64xB1y, EX(M)64xB6y	U <sub>i</sub> : 30V; I <sub>i</sub> : 100mA; P <sub>i</sub> : 1W; C <sub>i</sub> : 61nF; L <sub>i</sub> : 426.1µH
EXTO(M)64xA3y, EXTO(M)64xB3y	U <sub>i</sub> : 28V; I <sub>i</sub> : 120mA; P <sub>i</sub> : 1W; C <sub>i</sub> : 0nF; L <sub>i</sub> : 122.2µH
EXTO(M)64xA1y, EXTO(M)64xA6y, EXTO(M)64xB1y, EXTO(M)64xB6y	U <sub>i</sub> : 28V; I <sub>i</sub> : 120mA; P <sub>i</sub> : 1W; C <sub>i</sub> : 61nF; L <sub>i</sub> : 427.2µH
EXRV(M)64xA0y, EXRV(M)64xB0y	U <sub>i</sub> : 28V; I <sub>i</sub> : 120mA; P <sub>i</sub> : 1W; C <sub>i</sub> : 25nF; L <sub>i</sub> : 121.1µH
EXRV(M)64xA1y, EXRV(M)64xA6y, EXRV(M)64xB1y, EXRV(M)64xB6y	U <sub>i</sub> : 28V; I <sub>i</sub> : 120mA; P <sub>i</sub> : 1W; C <sub>i</sub> : 80nF; L <sub>i</sub> : 426.1µH
EX(M)64xB7y	U <sub>i</sub> : 30V; I <sub>i</sub> : 100mA; P <sub>i</sub> : 1W; C <sub>i</sub> : 0nF; L <sub>i</sub> : 121.1µH
EXTO(M)64xB7y	U <sub>i</sub> : 30V; I <sub>i</sub> : 120mA; P <sub>i</sub> : 1W; C <sub>i</sub> : 0nF; L <sub>i</sub> : 122.2µH
EXRV(M)64xB7y	U <sub>i</sub> : 30V; I <sub>i</sub> : 120mA; P <sub>i</sub> : 1W; C <sub>i</sub> : 25nF; L <sub>i</sub> : 121.1µH

Seul le texte en français peut engager la responsabilité du LCIE. Ce document ne peut être reproduit que dans son intégralité, sans aucune modification. Il est établi en accord avec le référentiel de certification ATEX du LCIE. The LCIE's liability applies only on the French text. This document may only be reproduced in its entirety and without any change. It is issued in accordance with LCIE's [ATEX Certification Rules](#)  
 CERT-ATEX-FORM 04 Rev. 02



# ATTESTATION D'EXAMEN UE DE TYPE - ANNEXE

## EU TYPE EXAMINATION CERTIFICATE - SCHEDULE

1 Version : 02

LCIE 05 ATEX 6154 X

Issue : 02

### MARQUAGE

Le marquage du produit doit comprendre :

**Marquage complet :**

PCB Piezotronics Inc. ou IMI Sensors ou IMI  
Adresse : ...  
Type : ...  
N° de fabrication : ...  
Année de fabrication : ...

⊕ II 1 G

Ex ia IIC T4 Ga  
LCIE 05 ATEX 6154 X  
-40°C ≤ T<sub>amb</sub> ≤ +80°C  
U<sub>i</sub> : ...V, I<sub>i</sub> : ...mA, P<sub>i</sub> : ...W, C<sub>i</sub> : ...nF, L<sub>i</sub> : ... μF  
(complété suivant le modèle)

**Marquage réduit :**

PCB Piezotronics Inc. ou IMI Sensors ou IMI  
Type : ...  
N° de fabrication : ...  
Année de fabrication : ...

⊕ II 1 G

Ex ia IIC T4 Ga, Ta = 80°C  
LCIE 05 ATEX 6154 X

L'appareil doit également comporter le marquage normalement prévu par les normes de construction qui le concernent sous la responsabilité du fabricant.

### MARKING

The marking of the product shall include the following :

**Full marking :**

PCB Piezotronics Inc. or IMI Sensors or IMI  
Address: ...  
Type: ...  
Serial number: ...  
Year of construction: ...

⊕ II 1 G

Ex ia IIC T4 Ga  
LCIE 05 ATEX 6154 X  
-40°C ≤ T<sub>amb</sub> ≤ +80°C  
U<sub>i</sub> : ...V, I<sub>i</sub> : ...mA, P<sub>i</sub> : ...W, C<sub>i</sub> : ...nF, L<sub>i</sub> : ... μF  
(completed following the model)

**Reduced marking :**

PCB Piezotronics Inc. or IMI Sensors or IMI  
Type : ...  
Serial number: ...  
Year of construction: ...

⊕ II 1 G

Ex ia IIC T4 Ga, Ta = 80°C  
LCIE 05 ATEX 6154 X

The equipment shall also bear the usual marking required by the product standards applying to such equipment under the manufacturer responsibility.

### 13 CONDITIONS PARTICULIERES D'UTILISATION

- Plage de température ambiante : -40°C à +80°C.
- Les matériels de sécurité intrinsèque ne doivent être raccordés qu'à des matériels associés de sécurité intrinsèque certifiés pour l'usage considéré. Cette association doit répondre aux exigences de la norme EN 60079-25.
- Le montage du produit dans une installation doit être effectué de telle sorte que le corps métallique du capteur et le blindage du câble soient reliés de manière fiable à la terre du système.
- L'appareil doit être raccordé conformément au manuel d'instruction.

### 14 EXIGENCES ESSENTIELLES DE SANTE ET DE SECURITE

Couvertes par les normes listées au point 8.

### 15 DOCUMENTS DESCRIPTIFS

N°	Description	Reference	Rev.	Date	Page(s)
1.	Notice d'instructions / <i>Instructions notice</i>	32836	-	-	3
2.	Dossier technique / <i>Technical file</i>	64777	NR	2018/06/28	42

### SPECIFIC CONDITIONS OF USE

Ambient temperature range: -40°C to +80°C.

The intrinsically safe apparatus shall only be connected to associated intrinsically safe apparatus certified for the intended use. This association shall comply with the requirements of the standard EN 60079-25.

The mounting of the apparatus into an installation must be carried out in such a way that sensor metallic body and cable shield are reliably connected to the system earth.

The apparatus must be connected according to instruction manual.

### ESSENTIAL HEALTH AND SAFETY REQUIREMENTS

Covered by standards listed at 8.

### DESCRIPTIVE DOCUMENTS

Seul le texte en français peut engager la responsabilité du LCIE. Ce document ne peut être reproduit que dans son intégralité, sans aucune modification. Il est établi en accord avec le référentiel de certification ATEX du LCIE. *The LCIE's liability applies only on the French text. This document may only be reproduced in its entirety and without any change. It is issued in accordance with LCIE's ATEX Certification Rules*  
CERT-ATEX-FORM 04 Rev. 02

Page 3 of 4

LCIE

Laboratoire Central des Industries Electriques  
Une société de Bureau Veritas

33 Avenue du Général Leclerc  
92260 Fontenay-aux-Roses  
FRANCE

WWW.LCIE.FR

## 16 INFORMATIONS COMPLEMENTAIRES

**Essais individuels**

Néant.

**Conditions de certification**

Les détenteurs d'attestations d'examen UE de type doivent également satisfaire les exigences de contrôle de production telles que définies à l'article 13 de la Directive 2014/34/UE.

## 17 DETAILS DES MODIFICATIONS

Version 00 : Version initiale.  
2005/12/07

Version 01 : Mise à jour normative suivant les normes EN 60079-0 (2006) et EN 60079-11 (2007).

Version 02 : - Mise à jour normative suivant les normes EN 60079-0:2012+A11:2013 et EN 60079-11 :2012.  
- Modification des paramètres de sécurité intrinsèque.  
- Distinction entre le nom du fabricant (PCB Piezotronics Inc) et le nom de la marque commerciale (IMI Sensors ou IMI).  
- Mise à jour de la nomenclature des modèles.

## ADDITIONAL INFORMATION

**Routine tests**

None.

**Conditions of certification**

Holder of UE type examination certificates are also required to comply with the production control requirements defined in article 13 of Directive 2014/34/UE.

## DETAILS OF CHANGES

Issue 00: Initial issue.  
2005/12/07

Issue 01: Normative update according to EN 60079-0 (2006) and EN 60079-11 (2007) standards.

Issue 02: - Normative update according to EN 60079-0:2012+A11:2013 and EN 60079-11:2012 standards.  
- Modification of intrinsic safety parameters.  
- Distinction between the name of manufacturer (PCB Piezotronics Inc.) and the name of trademark (IMI Sensors or IMI).  
- Update of the nomenclature of the models.





LCIE

1 AVENANT D'ATTESTATION D'EXAMEN CE DE TYPE

2 Appareil ou système de protection destiné à être utilisé en atmosphères explosibles (Directive 94/9/CE)

3 Numéro de l'avenant : LCIE 05 ATEX 6154 X / 01

4 Appareil ou système de protection : Capteurs de vibration
Type : EX64..., EXTO64..., EXVR64...

5 Demandeur : I.M.I.

15 DESCRIPTION DE L'AVENANT

Mise à jour normative selon les normes EN 60079-0 (2006) et EN 60079-11 (2007).

Les résultats des vérifications et essais figurent dans le rapport confidentiel N° 60058689/559760

Paramètres spécifiques du ou des modes de protection concerné(s) : Inchangés

Le marquage doit être modifié comme suit : Ex ia IIC T4

16 DOCUMENTS DESCRIPTIFS

Dossier de certification N° 27866 Rév. A du 27/06/2007. Ce dossier comprend 18 rubriques (37 pages). Dossier de certification N° 28770 Rév. A du 27/06/2007. Ce dossier comprend 12 rubriques (28 pages).

17 CONDITIONS SPECIALES POUR UNE UTILISATION SURE Inchangées

18 EXIGENCES ESSENTIELLES DE SECURITE ET DE SANTE Conformité aux normes européennes EN 60079-0 (2006) et EN 60079-11 (2007).

19 VERIFICATIONS ET ESSAIS INDIVIDUELS Néant

1 SUPPLEMENTARY EC TYPE EXAMINATION CERTIFICATE

2 Equipment or protective system intended for use in potentially explosive atmospheres (Directive 94/9/EC)

3 Supplementary certificate number : LCIE 05 ATEX 6154 X / 01

4 Equipment or protective system : Vibration sensors
Type : EX64..., EXTO64..., EXVR64...

5 Applicant : I.M.I.

15 DESCRIPTION OF THE SUPPLEMENTARY CERTIFICATE

Normative update according to EN 60079-0 (2006) and EN 60079-11 (2007) standards.

The examination and test results are recorded in confidential report N° 60058689/559760

Specific parameters of the mode(s) of protection concerned: Unchanged

The marking shall be modified as follows : Ex ia IIC T4

16 DESCRIPTIVE DOCUMENTS

Certification file N° 27866 Rev. A dated 27/06/2007. This file includes 18 items (37 pages). Certification file N° 28770 Rév. A dated 27/06/2007. This file includes 12 items (28 pages).

17 SPECIAL CONDITIONS FOR SAFE USE

Unchanged

18 ESSENTIAL HEALTH AND SAFETY REQUIREMENTS

Conformity to the European standards EN 60079-0 (2006) and EN 60079-11 (2007).

19 ROUTINE VERIFICATIONS AND TESTS

None

Fontenay-aux-Roses, le 2 août 2007

Le responsable de certification ATEX
ATEX certification manager



Signature of Henri CERVELLO

Seul le texte en français peut engager la responsabilité du LCIE. Ce document ne peut être reproduit que dans son intégralité, sans aucune modification.



LCIE

1 ATTESTATION D'EXAMEN CE DE TYPE

- 2 Appareils et systèmes de protection destinés à être utilisés en atmosphères explosibles  
Directive 94/9/CE
- 3 Numéro de l'attestation d'examen CE de type  
LCIE 05 ATEX 6154 X
- 4 Appareil ou système de protection :  
Capteurs de vibrations  
Type : EX64...,EXTO64...,EXRV64 (voir page suivante)
- 5 Demandeur : I.M.I. (Industrial Monitoring Instrumentation)
- 6 Adresse : A PCB PIEZOTRONICS DIVISION  
3425 Walden Avenue  
Depew, New York 14043  
U.S.A.
- 7 Cet appareil ou système de protection et ses variantes éventuelles acceptées est décrit dans l'annexe de la présente attestation et dans les documents descriptifs cités en annexe.
- 8 Le LCIE, organisme notifié sous la référence 0081 conformément à l'article 9 de la directive 94/9/CE du Parlement européen et du Conseil du 23 mars 1994, certifie que cet appareil ou système de protection est conforme aux exigences essentielles en ce qui concerne la sécurité et la santé pour la conception et la construction d'appareils et de systèmes de protection destinés à être utilisés en atmosphères explosibles, données dans l'annexe II de la directive. Les vérifications et épreuves figurent dans nos rapports confidentiels n° 60040901/540946/1.
- 9 Le respect des exigences essentielles en ce qui concerne la sécurité et la santé est assuré par la conformité aux documents suivants :  
-EN 50014 (1997) + amendements 1 et 2,  
-EN 50020 (2002).
- 10 Le signe X lorsqu'il est placé à la suite du numéro de l'attestation, indique que ce matériel ou système de protection est soumis aux conditions spéciales pour une utilisation sûre, mentionnées dans l'annexe de la présente attestation.
- 11 Cette attestation d'examen CE de type concerne uniquement la conception et la construction de l'appareil ou du système de protection spécifié, conformément à la directive 94/9/CE. Des exigences supplémentaires de cette directive sont applicables pour la fabrication et la fourniture de l'appareil ou du système de protection.
- 12 Le marquage de l'appareil ou du système de protection devra comporter, entre autres indications utiles, les mentions suivantes :  
 II 1 G  
EEx ia IIC T4

Fontenay-aux-Roses, le 7 décembre 2005

1 EC TYPE EXAMINATION CERTIFICATE

- 2 Equipment or protective system intended for use in potentially explosive atmospheres  
Directive 94/9/EC
- 3 EC type Examination Certificate number  
LCIE 05 ATEX 6154 X
- 4 Equipment or protective system :  
Vibration sensors  
Type : EX64...,EXTO64...,EXRV64... (see following page)
- 5 Applicant : I.M.I. (Industrial Monitoring Instrumentation)
- 6 Address : A PCB PIEZOTRONICS DIVISION  
3425 Walden Avenue  
Depew, New York 14043  
U.S.A.
- 7 This equipment or protective system and any acceptable variation thereto is specified in the schedule to this certificate and the documents therein referred to.
- 8 LCIE, notified body number 0081 in accordance with article 9 of the Directive 94/9/EC of the European Parliament and Council of 23 March 1994, certifies that this equipment or protective system has been found to comply with the essential Health and Safety Requirements relating to the design and construction of equipment and protective system intended for use in potentially explosive atmospheres, given in Annex II of the Directive.  
The examination and test results are recorded in confidential reports n° 60040901/540946/1.
- 9 Compliance with the Essential Health and Safety Requirements has been assured by compliance with :  
-EN 50014 (1997) + amendments 1 and 2,  
-EN 50020 (2002).
- 10 If the sign X is placed after the certificate number, it indicates that the equipment or protective system is subject to special conditions for safe use specified in the schedule to this certificate.
- 11 This EC Type examination certificate relates only to the design and construction of this specified equipment or protective system in accordance with the Directive 94/9/EC. Further requirements of the Directive applies to the manufacture and supply of this equipment or protective system.
- 12 The marking of the equipment or protective system shall include the following :  
 II 1 G  
EEx ia IIC T4

Le Directeur de l'organisme certificateur  
Manager of the certification body

Henri CERVELLO  
Timbre sec / Dry seal

Seul le texte en français peut engager la responsabilité du LCIE. Ce document ne peut être reproduit que dans son intégralité, sans aucune modification  
The LCIE's liability applies only on the French text. This document may be reproduced in full and without any change

IEg



LCIE

(A1) ANNEXE

(A1) SCHEDULE

(A2) ATTESTATION D'EXAMEN CE DE TYPE

(A2) EC TYPE EXAMINATION CERTIFICATE

LCIE 05 ATEX 6154 X

LCIE 05 ATEX 6154 X

(A3) Description de l'équipement ou du système de protection :

(A3) Description of Equipment or Protective System :

Capteurs de vibrations  
Type : EX64...,EXTO64...,EXRV64

Vibration sensors  
Type : EX64...,EXTO64...,EXRV64

Ce capteur est composé d'un ensemble piezo-cristal, d'une carte électronique et d'un connecteur ou un câble intégré.

This apparatus is made of a piezo-crystal assembly, an electronic board and a connector or an integrated cable.

Modèles concernés :  
EX64xB0y, EX64xB1y, EX64xB6y  
EXTO64xB3y, EXTO64xB1y, EXTO64xB6y,  
EXRV64xB0y, EXRV64xB1y, EXRV64xB6y,  
EX64xB7y, EXTO64xB7y, EXRV64xB7y  
EX64xA0y, EX64xA1y, EX64xA6y,  
EXTO64xA3y, EXTO64xA1y, EXTO64xA6y,  
EXRV64xA0y, EXRV64xA1y, EXRV64xA6y

Models concerned :  
EX64xB0y, EX64xB1y, EX64xB6y  
EXTO64xB3y, EXTO64xB1y, EXTO64xB6y,  
EXRV64xB0y, EXRV64xB1y, EXRV64xB6y,  
EX64xB7y, EXTO64xB7y, EXRV64xB7y  
EX64xA0y, EX64xA1y, EX64xA6y,  
EXTO64xA3y, EXTO64xA1y, EXTO64xA6y,  
EXRV64xA0y, EXRV64xA1y, EXRV64xA6y

Le marquage est le suivant :

Marking is as follow :

I.M.I. Adresse : ...  
Type : EX... (1)  
N° de fabrication : ... Année de fabrication : ...  
II 1 G EEx ia IIC T4  
LCIE 05 ATEX 6154 X  
T.amb. : - 40°C à + 80°C

I.M.I. Address : ...  
Type : EX... (1)  
Serial number : ... Year of manufacturing : ...  
II 1 G EEx ia IIC T4  
LCIE 05 ATEX 6154 X  
T.amb. : - 40°C to + 80°C

(1) Suivant le modèle

(1) According to the model

Le marquage CE est accompagné du numéro d'identification de l'organisme notifié responsable de la surveillance du système approuvé de qualité (0081 pour le LCIE).

The CE marking shall be accompanied by the identification number of the notified body responsible for surveillance of the approved quality system (0081 for LCIE).

Le matériel devra également comporter le marquage normalement prévu par les normes de construction du matériel électrique concerné.

The equipment must also bear the usual marking required by the manufacturing standards applying to such equipments.

Paramètres électriques relatifs à la sécurité :

Electrical parameters relative to safety :

Modèle / Model	Ui (V)	Ii (mA)	Pi (W)	Ci (nF)	Li (µH)
EX64xA0x, EX64xB0y	30	100	1	0	1,06
EX64xA1y, EX64xA6y, EX64xB1y, EX64xB6y	30	100	1	61	306
EXTO64xA3y, EXTO64xB3y	28	120	1	0	1,06
EXTO64xA1y, EXTO64xA6y, EXTO64xB1y, EXTO64xB6y	28	120	1	61	306
EXRV64xA0y, EXRV64xB0y	28	120	1	0	121,06
EXRV64xA1y, EXRV64xA6y, EXRV64xB1y, EXRV64xB6y	28	120	1	61	426
EX64xB7y	30	100	1	0	1,06
EXTO64xB7y, EXRV64xB7y	30	120	1	0	1,06

MEg



L C I E

(A1) ANNEXE

(A1) SCHEDULE

(A2) ATTESTATION D'EXAMEN CE DE TYPE

(A2) EC TYPE EXAMINATION CERTIFICATE

LCIE 05 ATEX 6154 X (suite)

LCIE 05 ATEX 6154 X (continued)

(A4) Documents descriptifs :

(A4) Descriptive documents :

Dossier technique N° 28770 Rév. NR du 10/10/2005.  
Ce document comporte 12 rubriques (28 pages).

Technical file No. 28770 Rev. NR dated 10/10/2005.  
This file includes 12 items (28 pages).

Dossier technique N° 27866 Rév. NR du 10/10/2005.  
Ce document comporte 18 rubriques (37 pages).

Technical file No. 27866 Rev. NR dated 10/10/2005.  
This file includes 18 items (37 pages).

(A5) Conditions spéciales pour une utilisation sûre :

(A5) Special conditions for safe use :

Ce matériel est un appareil de sécurité intrinsèque, il peut être placé en atmosphère explosible.

This equipment is an intrinsically safe apparatus, it can be mounted in explosive atmosphere.

Le matériel ne doit être raccordé qu'à un matériel associé de sécurité intrinsèque certifié et cette association doit être compatible du point de vue sécurité intrinsèque (voir paramètres électriques au paragraphe (A3)).

The apparatus must be only connected to a certified associated intrinsically safe equipment and this combination must be compatible regarding intrinsic safety rules (see electrical parameters clause (A3)).

Température ambiante d'utilisation : - 40°C à + 80°C.

Operating ambient temperature : - 40°C to + 80°C.

(A6) Exigences essentielles en ce qui concerne la sécurité et la santé :

(A6) Essential Health and Safety Requirements :

Conformité aux normes européennes EN 50014 (1997 + amendements 1 et 2) et EN 50020 (2002).

Conformity to the European standards EN 50014 (1997 + amendments 1 and 2) and EN 50020 (2002).

Vérifications et épreuves individuelles :

Individual examinations and tests :

L'appareil est dispensé d'épreuve individuelle.

The equipment is not submitted to routine test.



*To: IMI*

Fontenay-aux-Roses, le 27 JUN 2001

N/Réf. : MLI/SFe/ ENV 9183  
Affaire suivie par Monsieur Michel EQUI  
Tél. : 33-(1) 40.95.62.63  
Fax : 33-(1) 40.95.89.37

IMI  
A division of PCB Piezotronics INC.  
3425 Walden Avenue, Depew, New York  
14043 USA

*For the attention of*

A l'attention de Mr. Nick FULCINITI

*SUBJECT : Modification of the Certificate of Conformity*  
**OBJET : MODIFICATION DU CERTIFICAT DE CONFORMITÉ LCIE 01.E6029 X.**

Messieurs,

*Following your above-referenced request, we request that you please find attached the document modified accordingly.*  
Comme suite à votre demande ci-dessus référencée, nous vous prions de bien vouloir trouver ci-joint le document dûment modifié.

*We wish you receipt in good condition and we remind you that the retention of modified documents in your possession is your responsibility.*  
Nous vous en souhaitons bonne réception et vous rappelons que la gestion des documents modifiés, en votre possession, est de votre responsabilité.

*"We extend, Sirs, the expression of our best wishes"*  
Veuillez agréer, Messieurs, l'expression de nos sentiments distingués.

Le secrétariat

**COPY**

*with Translation in red ink*

Ginette DELATOUCHE

*John Couture  
02 July 2001*



Fontenay-aux-Roses, le 27 JUIN 2001

N/Réf. : MLI/SFe/ ENV 9183  
Affaire suivie par Monsieur Michel EQUI  
Tél. : 33-(1) 40.95.62.63  
Fax : 33-(1) 40.95.89.37

IMI  
A division of PCB Piezotronics INC.  
3425 Walden Avenue, Depew, New York  
14043 USA

A l'attention de Mr. Nick FULCINITI

**OBJET** : MODIFICATION DU CERTIFICAT DE CONFORMITÉ LCIE 01.E6029 X.

Messieurs,

Comme suite à votre demande ci-dessus référencée, nous vous prions de bien vouloir trouver ci-joint le document dûment modifié.

Nous vous en souhaitons bonne réception et vous rappelons que la gestion des documents modifiés, en votre possession, est de votre responsabilité.

Veillez agréer, Messieurs, l'expression de nos sentiments distingués.

Le secrétariat

Ginette DELATOUCHE

L30330/Env/S87

■ LABORATOIRE CENTRAL DES INDUSTRIES ELECTRIQUES

Société anonyme à Directoire et Conseil de surveillance au capital de 103 592 000 Francs  
RCS Nanterre B 408 363 174 - N° siret : 408 363 174 00017 - APE 743 B

Siège social : 33, avenue du Général Leclerc - F 92260 Fontenay-aux-Roses - Tél. : +33 (0)1 40 95 60 60  
Correspondance : BP n° 8 - F 92266 Fontenay-aux-Roses cedex Fax : +33 (0)1 40 95 86 56



**MATÉRIEL OU SYSTÈME ÉLECTRIQUE POUR  
ATMOSPHÈRES EXPLOSIVES**

- (1) **CERTIFICAT DE CONFORMITÉ**  
(2) **LCIE 01.E6029 X**

(3) Le présent certificat est délivré pour :

Capteurs de vibrations  
Types : EX64 ...

(4) construit et soumis à la certification par :

IMI  
PCB PIEZOTRONICS INC.  
3425 Walden Avenue, Depew, New York  
14043 USA

(5) Ce matériel ou système électrique et ses variantes éventuelles acceptées sont décrits dans l'annexe du présent certificat et dans les documents descriptifs qui y sont mentionnés.

(6) Le LCIE, organisme notifié conformément à l'article 14 de la directive du Conseil des communautés européennes 76/117/CEE du 18 décembre 1975,

- certifie que ce matériel électrique est conforme aux normes européennes harmonisées :

- . EN 50014 (1992) NF EN 50014 (1993)
- . EN 50020 (1994) NF EN 50020 (1995)

et qu'il a subi avec succès les vérifications et épreuves de type prescrites par ces normes,

- certifie avoir établi un procès-verbal confidentiel de ces vérifications et épreuves.

(7) Le code de ce matériel électrique est :

EEx ia IIC T4

(10) Par le marquage du matériel livré, le fournisseur atteste, sous sa propre responsabilité, que ce matériel est conforme aux documents descriptifs cités dans l'annexe du présent certificat et qu'il a subi avec succès les vérifications et épreuves individuelles prescrites par les normes européennes harmonisées mentionnées au point (6) ci-dessus.

(11) Le matériel électrique livré est autorisé à porter la marque distinctive communautaire définie dans l'annexe II de la directive 79/196/CEE du 6 février 1979. Cette marque figure sur la première page du présent certificat ; elle doit être apposée sur le matériel électrique de manière à être visible, lisible et durable.

(12) Le signe X lorsqu'il est placé à la suite du numéro du certificat de conformité indique que ce matériel électrique est soumis aux conditions spéciales pour une utilisation sûre, mentionnées dans l'annexe du présent certificat.



**ELECTRICAL EQUIPMENT OR SYSTEM FOR  
EXPLOSIVE ATMOSPHERE**

- (1) **CERTIFICATE OF CONFORMITY**  
(2) **LCIE 01.E6029 X**

(3) The present certificate is issued for :

Vibrations sensors  
Types : EX64 ...

(4) manufactured and submitted for certification by :

IMI  
PCB PIEZOTRONICS INC.  
3425 Walden Avenue, Depew, New York  
14043 USA

(5) This electrical equipment or system and any accepted variations thereof are specified in the annex to this certificate and in the descriptive documents therein referred to.

(6) LCIE, as an approved certification body in accordance with article 14 of the European Communities Council Directive 76/117/EEC of December 18, 1975,

- certifies that it has fully satisfied the type examination and test requirements of these standards,

- . EN 50014 (1992) NF EN 50014 (1993)
- . EN 50020 (1994) NF EN 50020 (1995)

and that it has fully satisfied the type examination and test requirements of these standards,

- certifies that a confidential test report has been completed on these type examinations and tests.

(7) The code of this electrical equipment is :

EEx ia IIC T4

(10) By marking the electrical equipment supplied, the manufacturer attests on his own responsibility that this electrical equipment complies with the descriptive documents referred to in the annex to this certificate and that it has fully satisfied individual examinations and tests required by the harmonized European standards specified in (6) above :

(11) The electrical equipment supplied is authorized to display the distinctive European Community mark specified in annex II of the directive 79/196/CEE of February 6, 1979. The mark appears at the top of this certificate. It must be applied to the electrical equipment so as to be visible, legible and permanent.

(12) When an X appears after the certificate number, special conditions applied to the electrical equipment for its safe use. These are specified in the annex to this certificate.

(13-14) Fontenay-aux-Roses, le 30 mai 2001

Le Directeur de l'organisme certificateur  
Manager of the certification body

Timbre sec/dry seal

Par délégation  
**Michel BRÉNON**  
Directeur adjoint  
à la Certification

(7) Code : EEx ia IIC T4

Page 1/2  
A

(8) Seul le texte en français peut engager la responsabilité du LCIE. Ce document ne peut être reproduit que dans son intégralité, sans aucune modification.  
The LCIE's liability applies only on the French text. This document may only be reproduced in full and without any change.

**LABORATOIRE CENTRAL DES INDUSTRIES ÉLECTRIQUES**

Société anonyme à Directoire et Conseil de surveillance au capital de 103 592 000 Francs - RCS Nanterre B 408 363 174

Siège social : 33, avenue du Général Leclerc - F 92260 Fontenay-aux-Roses - Tél. : +33 (0)1 40 95 60 60

(9) **CERTIFICAT DE CONFORMITÉ**  
**LCIE 01.E6029 X**

**ANNEXE**

(A1) DÉSIGNATION DU MATÉRIEL OU SYSTÈME ÉLECTRIQUE CERTIFIÉ :

Capteurs de vibrations  
Types : EX64 ...

(A2) DESCRIPTION DU MATÉRIEL OU SYSTÈME ÉLECTRIQUE CERTIFIÉ :

La matériel est composé d'un ensemble piezo-cristal, d'une carte électronique et d'un connecteur ou d'un câble intégré.

Connecteur :

Types : EX64xA00, EX64xA01 et EX64xA02

Câble intégré (305 m) :

Types : EX64xA10, EX64xA11 et EX64xA12  
EX64xA60, EX64xA61 et EX64xA62

(A3) DOCUMENTS DESCRIPTIFS :

Dossier de certification n° 220490 Rév. 0 du 13/04/2001.  
Ce dossier comprend 19 rubriques (83 pages).

(A4) PARAMÈTRES SPÉCIFIQUES DU OU DES MODES DE PROTECTION CONCERNÉS :

Types : EX64xA0x :

$U_i \leq 28 \text{ V}$  ;  $I_i \leq 93 \text{ mA}$  ;  $P_i \leq 1 \text{ W}$  ;  $C_i = 0$  ;  $L_i = 0$

Types : EX64xA1x et/and EX64xA6x (305 m de câble/305 m of Cable)

$U_i \leq 28 \text{ V}$  ;  $I_i \leq 93 \text{ mA}$  ;  $P_i \leq 1 \text{ W}$  ;  $C_i \leq 61 \text{ nF}$  ;  $L_i \leq 0,305 \text{ mH}$

(A5) MARQUAGE DU MATÉRIEL CERTIFIÉ :

Le marquage doit être visible, lisible et durable ; il doit comporter les indications suivantes :

IMI  
Type : EX64xAxx (1)  
n° de fabrication : ...  
EEx ia IIC T4  
LCIE 01.E6029 X

(1) Complété par le modèle.

Le matériel devra également comporter le marquage normalement prévu par les normes de construction du matériel électrique concerné.

(A6) VÉRIFICATIONS ET ÉPREUVES INDIVIDUELLES :

Néant.

(A7) CONDITIONS SPÉCIALES POUR UNE UTILISATION SÛRE :

Le matériel est un appareil à sécurité intrinsèque, il peut être placé en atmosphères explosibles.

Le matériel ne doit être raccordé qu'à un matériel associé de sécurité intrinsèque certifié et cette association doit être compatible du point de vue de la sécurité intrinsèque.

Les caractéristiques électriques du matériel associé de sécurité intrinsèque ne doivent excéder aucune des valeurs suivantes :

$U_o \leq 28 \text{ V}$  ,  $I_o \leq 93 \text{ mA}$  ,  $P_o \leq 1 \text{ W}$

Température ambiante d'utilisation : - 40 °C à + 80 °C.

(9) **CERTIFICATE OF CONFORMITY**  
**LCIE 01.E6029 X**

**SCHEDULE**

(A1) NAME OF THE CERTIFIED ELECTRICAL EQUIPMENT OR SYSTEM :

Vibrations sensors  
Types : EX64 ...

(A2) DESCRIPTION OF THE CERTIFIED ELECTRICAL EQUIPMENT OR SYSTEM :

The apparatus is formed of a piezo-crystal assembly, an electronic board and a connector or an integral cable.

Connector :

Types : EX64xA00, EX64xA01 and EX64xA02

Integral cable (305 m) :

Types : EX64xA10, EX64xA11 and EX64xA12  
EX64xA60, EX64xA61 and EX64xA62

(A3) DESCRIPTIVE DOCUMENTS :

Certification file n° 220490 Rev.0 dated 13/04/2001.  
This file included 19 items (83 pages).

(A4) SPECIFIC PARAMETERS OF THE MODE(S) OF PROTECTION CONCERNED :

Types : EX64xA0x :

$U_i \leq 28 \text{ V}$  ;  $I_i \leq 93 \text{ mA}$  ;  $P_i \leq 1 \text{ W}$  ;  $C_i = 0$  ;  $L_i = 0$

Types : EX64xA1x et/and EX64xA6x (305 m de câble/305 m of Cable)

$U_i \leq 28 \text{ V}$  ;  $I_i \leq 93 \text{ mA}$  ;  $P_i \leq 1 \text{ W}$  ;  $C_i \leq 61 \text{ nF}$  ;  $L_i \leq 0,305 \text{ mH}$

(A5) MARKING OF THE CERTIFIED EQUIPMENT :

The marking must be visible, legible and permanent, and must include the following information :

IMI  
Type : EX64xAxx (1)  
Serial number : ...  
EEx ia IIC T4  
LCIE 01.E6029 X

(1) Completed by the model.

The equipment must also carry the usual marking required by the manufacturing standards applying to such equipments.

(A6) INDIVIDUAL EXAMINATIONS AND TESTS :

None.

(A7) SPECIAL CONDITIONS FOR SAFE USE :

The equipment is an intrinsically safe apparatus, it can be mounted in explosive atmosphere.

The apparatus must be only connected to a certified associated intrinsically safe equipment and this combinaison must be compatible as regards intrinsic safety rules.

The electrical parameters of the associated intrinsically safe equipment must not exceed any of the following values :

$U_o \leq 28 \text{ V}$  ,  $I_o \leq 93 \text{ mA}$  ,  $P_o \leq 1 \text{ W}$

Ambient operating temperature : - 40 °C to + 80 °C.



1 **EXAMINATION CERTIFICATE**

2 **Component Intended for use in Potentially Explosive Atmospheres meeting ATEX Directive 2014/34/EU**

3 **Examination Certificate Number: CTD011 X to be used in conjunction with the Type Examination Certificate LCIE 05 ATEX 6154 X, Issue: 01**

4 **Apparatus:** Models EX64xA0y, EXM64xA0y, EX64xB0y, and EXM64xB0y Series  
EXRV64xA0y, EXRVM64xA0y, EXRV64xB0y, and EXRVM64xB0y Series  
EXTO64xA3y, EXTOM64xA3y, EXTO64xB3y, and EXTOM64xB3y Series  
EX64xA1y, EXM64xA1y, EXTO64xA1y, EXRV64xA1y, EXTOM64xA1y, and EXRVM64xA1y Series  
EX64xB1y, EXM64xB1y, EXTO64xB1y, EXRV64xB1y, EXTOM64xB1y, and EXRVM64xB1y Series  
EX64xA6y, EXM64xA6y, EXTO64xA6y, EXRV64xA6y, EXTOM64xA6y, and EXRVM64xA6y Series  
EX64xB6y, EXM64xB6y, EXTO64xB6y, EXRV64xB6y, EXTOM64xB6y, and EXRVM64xB6y Series  
EX64xB7y, EXTO64xB7y, and EXRV64xB7y Series

The “x” and “y” represent a single digit from 0-9 representing model number and connector type

5 **Manufacturer:** IMI Sensors, a Division of PCB Piezotronics

6 **Address:** 3425 Walden Avenue, Depew, New York, 14043

7 This apparatus and any acceptable variation are specified in the schedule in this certificate and all pertinent documents referenced.

8 IMI Sensors certifies that this component has been found to comply with the Essential Health and Safety Requirements relating to the design and construction of components intended to form part of Category 3 equipment intended for use in potentially explosive atmospheres given in Annex II to European Union Directive 2014/34/EU of February 2014. This certificate is based on LCIE confidential report(s) n° 60058689/559760 and 60040901/540946/1, for the above models certified to Equipment Group II Category 1 Gas Group.

9 Compliance with the Essential Health and Safety Requirements has been assured by compliance with:

EN 60079-0:2012+A11:2013  
EN 60079-11:2012

10 The apparatus may be connected to other ATEX certified equipment, as long as it meets the parameters of the system.

11 This Examination Certificate relates only to the design and construction of this specified equipment in accordance to Directive 2014/34/EU

12 Equipment will be marked per previous approvals:



This Certificate implies that the equipment can also be used in:



This certificate may only be reproduced in its entirety, without any change, schedule included.

13

**Schedule**

14

**Certificate Number CTD011 X**

15 **Description of component**

4-20 mA VELOCITY SENSOR:

Type: Models EX64xA0y, EXM64xA0y, EX64xB0y, and EXM64xB0y Series  
 EXRV64xA0y, EXRVM64xA0y, EXRV64xB0y, and EXRVM64xB0y Series  
 EXTO64xA3y, EXTOM64xA3y, EXTO64xB3y, and EXTOM64xB3y Series  
 EX64xA1y, EXM64xA1y, EXTO64xA1y, EXRV64xA1y, EXTOM64xA1y, and EXRVM64xA1y Series  
 EX64xB1y, EXM64xB1y, EXTO64xB1y, EXRV64xB1y, EXTOM64xB1y, and EXRVM64xB1y Series  
 EX64xA6y, EXM64xA6y, EXTO64xA6y, EXRV64xA6y, EXTOM64xA6y, and EXRVM64xA6y Series  
 EX64xB6y, EXM64xB6y, EXTO64xB6y, EXRV64xB6y, EXTOM64xB6y, and EXRVM64xB6y Series  
 EX64xB7y, EXTO64xB7y, and EXRV64xB7y Series

This apparatus is made of a piezo-crystal assembly, an electronic board and a connector or an integral cable.

**Electrical Parameters Relative to Safety**

<b>Model</b> ("M" – Metric versions included)	Ui (V)	Ii (mA)	Pi (W)	Ci (nF)	Li (µH)
EX64xA0x, EX64xB0y	30	100	1	0	1,06
EX64xA1y, EX64xA6y, EX64xB1y, EX64xB6y	30	100	1	61	360
EXTO64xA3y, EXTO64xB3y	28	120	1	0	1,06
EXTO64xA1y, EXTO64xA6y, EXTO64xB1y, EXTO64xB6y	28	120	1	61	306
EXRV64xA0y, EXRV64xB0y	28	120	1	0	121,06
EXRV64xA1y, EXRV64xA6y, EXRV64xB1y, EXRV64xB6y	28	120	1	61	426
EX64xB7y	30	100	1	0	1,06
EXTO64xB7y, EXRV64xB7y	30	120	1	0	1,06

16 **Descriptive Documents:**

Technical Files No. 27866, 27867

17 **Special Conditions for Safe Use:**

The supply electrical parameters shall not exceed the values mentioned in the table above.

18 **Essential Health and Safety Requirements**

All relevant Essential Health and Safety Requirements are covered by the standards listed in item 9.

Carrie Termin  
 Quality Engineer  
 On Behalf of IMI Sensors, a Division of PCB Piezotronics

*Carrie Termin* 05/25/17



CTD011



LCIE

# ATTESTATION D'EXAMEN DE TYPE TYPE EXAMINATION CERTIFICATE



1 Version : 03

**LCIE 05 ATEX 6155 X**

Issue : 03

- |  |   |
|--|---|
| <p><b>Directive 2014/34/UE</b></p> <p>2 Appareil ou Système de Protection destiné à être utilisé en Atmosphères Explosibles</p> <p>3 Produit :<br/><b>Capteurs de vibration</b></p> <p>4 Fabricant :</p> <p>5 Adresse :</p> <p>6 Ce produit et ses variantes éventuelles acceptées sont décrits dans l'annexe de la présente attestation et dans les documents descriptifs cités en référence.</p> <p>7 Le LCIE certifie que ce produit est conforme aux Exigences Essentielles de Sécurité et de Santé pour la conception et la construction de produits destinés à être utilisés en atmosphères explosibles, données dans l'annexe II de la Directive.<br/>Les résultats des vérifications et essais figurent dans le(s) rapport(s) confidentiel(s) N° :</p> <p>8 Le respect des Exigences Essentielles de Sécurité et de Santé est assuré par la conformité à :</p> <p>9 Le signe « X » lorsqu'il est placé à la suite du numéro de l'attestation, indique que cet appareil est soumis aux conditions particulières d'utilisation, mentionnées dans l'annexe de cette attestation.</p> <p>10 Cette Attestation d'Examen de Type concerne uniquement la conception et la construction du produit spécifié.<br/>Des exigences supplémentaires de la directive sont applicables pour la fabrication et la fourniture du produit. Ces dernières ne sont pas couvertes par la présente attestation.</p> <p>11 Le marquage du produit est mentionné dans l'annexe de cette attestation.</p> | <p><b>Directive 2014/34/EU</b></p> <p>Equipment or Protective System Intended for use in Potentially Explosive Atmospheres</p> <p>Product :<br/><b>Vibration sensors</b></p> <p><b>Type: EX(M)64****/M**, EXTO(M)64****/M**, EXRV(M)64****/M**</b></p> <p>Manufacturer :<br/><b>PCB Piezotronics Inc.</b></p> <p>Address :<br/><b>3425 Walden Avenue<br/>Depew, New York 14043<br/>États-Unis d'Amérique</b></p> <p>This product and any acceptable variation thereto are specified in the schedule to this certificate and the documents therein referred to.</p> <p>LCIE certifies that product has been found to comply with the Essential Health and Safety Requirements relating to the design and construction of products intended for use in potentially explosive atmospheres, given in Annex II to the Directive.<br/>The examination and test results are recorded in confidential report(s) N°:<br/><b>140596-682759 ; 162903-740871</b></p> <p>Compliance with the Essential Health and Safety Requirements has been assured by compliance with :<br/><b>EN IEC 60079-0:2018<br/>EN 60079-7:2015 + A1:2018</b></p> <p>If the sign "X" is placed after the certificate number, it indicates that the product is subject to the Specific Conditions of Use specified in the schedule to this certificate.</p> <p>This Type Examination Certificate relates only to the design and construction of the specified product.<br/>Further requirements of the Directive apply to the manufacturing process and supply of this product. These are not covered by this certificate.</p> <p>The marking of the product is specified in the schedule to this certificate.</p> |
|--|---|

Fontenay-aux-Roses, le 28 février 2023

Responsable de Certification

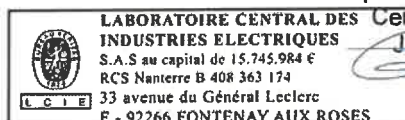

Certification Officer  
**Julien Gauthier**



# ATTESTATION D'EXAMEN DE TYPE - ANNEXE

## TYPE EXAMINATION CERTIFICATE - SCHEDULE

1 Version : 03

LCIE 05 ATEX 6155 X

Issue : 03

### 12 DESCRIPTION DU PRODUIT

Ces capteurs de vibration ont un boîtier en acier inoxydable intégrant une électronique, complètement encapsulée dans un composé d'empotage, associée à un élément sensible (cristal piézoélectrique avec une valeur de capacité  $\leq 700$  pF). La construction du boîtier métallique du capteur est entièrement soudée. La forme du boîtier diffère selon le modèle du capteur.

Les capteurs sont équipés d'un connecteur intégré ou d'un câble intégré (non armé ou armé). La longueur maximale du câble est de 305 m.

Le raccordement électrique peut également se faire via un bornier ou des conducteurs volants selon le modèle de capteur. Dans ce cas, le capteur de vibration est vissé, grâce à un filetage externe 1" NPT, dans un coude de conduit Y-3 (100-7094-90) de Killark procurant un degré de protection IP54.

Les capteurs de vibration fournissent en sortie un courant de 4-20 mA lorsqu'ils sont soumis à un mouvement mécanique. Les produits avec option TO incluent une sortie 4-20mA supplémentaire indépendante pour la mesure de la température. Le capteur de température intégré surveille l'environnement interne au boîtier du capteur.

Les produits avec option RV fournissent en sortie une tension de 0-2,5 V c.a. et 2,5 V c.c. correspondant à la vibration brute de l'accéléromètre intégré.

### DESCRIPTION OF PRODUCT

These vibration sensors have a stainless steel housing comprising of electronics, completely encapsulated in potting compound, associated to a sensing element (piezoelectric crystal with a capacitance value  $\leq 700$  pF).

The metallic enclosure of the sensor is a fully welded construction. The shape of the housing differs depending on the model of the sensor.

The sensors are fitted with an integral connector or an integral (unarmoured or armoured) cable. The maximum length of cable is 305 m.

The electrical connection can also be done via a terminal block or flying leads depending on the type of the equipment. In this case, the vibration sensor is screwed, thanks to a 1 inch NPT external thread, into a Y-3 capped conduit elbow (100-7094-90) from Killark providing a degree of protection IP54.

The vibration sensors provide a 4-20mA current output when subjected to mechanical motion.

The products with TO (Temperature Output) option includes an additional independent 4-20mA output for temperature measurement. The imbedded temperature sensor monitors the environment internal to the sensor housing.

The products with RV option include a 0-2.5 V a.c. and 2.5 V d.c. output that corresponds to raw vibration from the imbedded accelerometer.

Type de l'équipement <i>Type of the equipment</i>	Configuration
EX(M)64**0**, EX(M)64**9**	Avec connecteur intégré <i>with integral connector</i>
EX(M)64**1**/M**, EX(M)64**6**/M**	Avec câble intégré <i>with integral cable</i>
EXTO(M)64**3**, EXTO(M)64**9**	Avec sortie température et connecteur <i>with Temperature Output and connector</i>
EXTO(M)64**1**/M**, EXTO(M)64**6**/M**	Avec sortie température et câble intégré <i>with Temperature Output and integral cable</i>
EXRV(M)64**0**, EXRV(M)64**9**	Avec sortie vibration brute et connecteur <i>with Raw Vibration Output and connector</i>
EXRV(M)64**1**/M**, EXRV(M)64**6**/M**	Avec sortie vibration brute et câble intégré <i>with Raw Vibration Output and integral cable</i>
EX(M)64**7**, EX(M)64**8**	Avec conducteurs volants ou bornier + coude de conduit <i>with flying leads or terminal block + capped conduit elbow</i>
EXRV(M)64**7** EXRV(M)64**8**	Avec sortie vibration brute et conducteurs volants ou bornier + coude de conduit <i>with Raw Vibration Output and flying leads or terminal block + capped conduit elbow</i>

### CARACTERISTIQUES

Tension maximum d'entrée  $U_{max}$  : 30 V d.c.

Puissance maximale  $P_{max}$  : 1 W

### RATINGS

Maximum input voltage  $U_{max}$  : 30 V d.c.

Maximum power  $P_{max}$  : 1 W

Seul le texte en français peut engager la responsabilité de LCIE. Ce document ne peut être reproduit que dans son intégralité, sans aucune modification. Il est établi en accord avec le [référentiel de certification ATEX](#) de LCIE. *The LCIE's liability applies only on the French text. This document may only be reproduced in its entirety and without any change. It is issued in accordance with LCIE's [ATEX Certification Rules](#).*  
CERT-ATEX-FORM 05 Rev. 05



# ATTESTATION D'EXAMEN DE TYPE - ANNEXE

## TYPE EXAMINATION CERTIFICATE - SCHEDULE

1 Version : 03

LCIE 05 ATEX 6155 X

Issue : 03

### DETAIL DE LA GAMME

### RANGE DETAILS

EX	*	64	*	*	*	*	*	/	M	*	*	
<p>Deux caractères optionnels pour désigner le type de terminaison du câble</p> <p>Trois à six chiffres optionnels utilisant xxx-xx pour désigner la longueur en pieds-pouces ou mètres-centimètres avec M dans la colonne précédente</p> <p>Longueur de câble métrique en option</p> <p>Modificateur de longueur de câble en option</p> <p>Pour M uniquement ; Un nombre (01 à 999) qui désigne un numéro de modèle spécial avec une sensibilité, une plage de mesure, une plage de fréquence, une longueur de câble et une terminaison de câble personnalisés. Peut inclure d'ajouter le logo du client et le numéro de modèle en plus du modèle et du logo PCB.</p> <p>Un chiffre ou une lettre 0, 1, 2, 3, 4, 5, 6, 7, 8, 9, M qui désigne la plage de mesure et le filtrage M = Spécial client</p> <p>Un chiffre 0, 1, 3, 6, 7, 8 ou 9 qui désigne le type de connecteur 0 = Pour connecteur MIL-C-5015 à 2 broches ou MIL-C-5015 à 3 broches si option RV 1 = Pour câble intégral gainé en polyuréthane 3 = Pour connecteur MIL-C-26482 à 4 broches pour option TO 6 = Câble intégral armé gainé en polyuréthane 7 = Bornier pour capteur version coude coiffé de conduit 8 = Conducteurs volants pour capteur version coude coiffé de conduit 9 = Pour connecteur M12 4/5 broches</p> <p>Une lettre de A à Z pour indiquer le niveau de révision du modèle</p> <p>Un chiffre 0, 1, 2, 3, 4, 5, 6, 7 ou 8 qui indique le type de capteur et la plage de mesure de sortie 0 = Pour les configurations Sortie par le haut ou Coude de conduit avec plage de mesure en in/sec crête 1 = Pour les configurations Sortie par le haut ou Coude de conduit avec plage de mesure en in/sec valeur efficace 2 = Pour les configurations Sortie sur le côté avec plage de mesure en in/sec crête 3 = Pour les configurations Sortie sur le côté avec plage de mesure en in/sec valeur efficace 4 = Réserve pour un futur emplacement de sortie et plage de mesure 5 = Pour les configurations Sortie par le haut ou Coude de conduit avec plage de mesure de 0 à 5 g valeur efficace 6 = Pour les configurations Sortie par le haut ou Coude de conduit avec plage de mesure de 0 à 10 g valeur efficace 7 = Pour les configurations Sortie sur le côté avec plage de mesure de 0 à 5 g valeur efficace 8 = Pour les configurations Sortie sur le côté avec plage de mesure de 0 à 10 g valeur efficace</p> <p>Famille de capteurs de la série 64</p> <p>Une ou plusieurs options de capteur M = Monture métrique TO = Sortie Température RV = Sortie Vibration brute</p> <p>Type de produit : EX = ATEX/IECEX Produit</p>												



# ATTESTATION D'EXAMEN DE TYPE - ANNEXE

## TYPE EXAMINATION CERTIFICATE - SCHEDULE

1 Version : 03

**LCIE 05 ATEX 6155 X**

Issue : 03

EX	*	64	*	*	*	*	*	/	M	*	*	
<p style="margin-left: 150px;">Optional Two characters to designate cable termination type</p> <p style="margin-left: 150px;">Optional Three to six digits using xxx-xx to designate length in feet-inches or meters-centimeters with M in previous column</p> <p style="margin-left: 150px;">Optional Metric Cable Length</p> <p style="margin-left: 150px;">Optional Cable length modifier</p> <p style="margin-left: 150px;">For M only; A number (01 to 999) which designates a special model number with custom sensitivity, measurement range, frequency range, cable length and cable termination. May include added customer Logo and model number in addition to PCB Model and Logo.</p> <p style="margin-left: 150px;">A number or letter 0, 1, 2, 3, 4, 5, 6, 7, 8, 9, M which designates measurement range and filtering M = Customer special</p> <p style="margin-left: 150px;">One number 0, 1, 3, 6, 7, 8 or 9 which denotes the type of connector: 0 = For 2-Pin MIL-C-5015 connector or 3-Pin MIL-C-5015 if RV option 1 = For Integral polyurethane jacketed cable 3 = For 4-Pin MIL-C-26482 connector for TO option 6 = Integral armoured polyurethane jacketed cable 7 = Terminal Block for conduit hub version sensor (with capped elbow) 8 = Flying Leads for conduit hub version sensor (with capped elbow) 9 = For M12 4/5-Pin connector</p> <p style="margin-left: 150px;">One letter A to Z to denote model revision level</p> <p style="margin-left: 150px;">One number 0, 1, 2, 3, 4, 5, 6, 7 or 8 which denotes the type of sensor and output measurement range: 0 = For Top-Exit or Conduit Hub configurations with measurement range in in/sec pk 1 = For Top-Exit or Conduit Hub configurations with measurement range in in/sec rms 2 = For Side-Exit configurations with measurement range in in/sec pk 3 = For Side-Exit configurations with measurement range in in/sec rms 4 = Reserved for future exit location and measurement range 5 = For Top-Exit or Conduit Hub configurations with measurement range of 0 to 5 g rms 6 = For Top-Exit or conduit Hub configurations with measurement range of 0 to 10 g rms 7 = For Side-Exit configurations with measurement range of 0 to 5 g rms 8 = For Side-Exit configurations with measurement range of 0 to 10 g rms</p> <p style="margin-left: 150px;">64 Series Family of sensors</p> <p style="margin-left: 150px;">One or more Sensor Options: M = Metric Mount TO = Temperature Output RV = Raw Vibration Output</p> <p style="margin-left: 150px;">Product Type : EX = ATEX/IECEX Product</p>												

**MARQUAGE**

Le marquage du produit doit comprendre :

Marquage complet :

PCB Piezotronics Inc. ou IMI Sensors ou IMI

Adresse : ...

Type : ... <sup>(1)</sup>

Numéro de fabrication : ...

Année de fabrication : ...

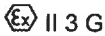
 Ex II 3 G

Ex ec IIC T4 Gc

LCIE 05 ATEX 6155 X

$-40\text{ °C} \leq T_{\text{amb}} \leq +80\text{ °C}$

AVERTISSEMENT – NE PAS CONNECTER OU  
DECONNECTER SOUS TENSION

Marquage réduit :

PCB Piezotronics Inc. ou IMI Sensors ou IMI

Type : ... <sup>(1)</sup>

N° de fabrication : ...

Année de fabrication : ...

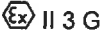
 Ex II 3 G

Ex ec IIC T4 Gc

T<sub>a</sub> = 80 °C

LCIE 05 ATEX 6155 X

<sup>(1)</sup> Voir le détail de la gamme ci-dessus

L'appareil doit également comporter le marquage normalement prévu par les normes de construction qui le concernent sous la responsabilité du fabricant.

**MARKING**

The marking of the product shall include the following :

Full marking:

PCB Piezotronics Inc. or IMI Sensors or IMI

Address : ...

Type : ... <sup>(1)</sup>

Serial number : ...

Year of construction : ...

 Ex II 3 G

Ex ec IIC T4 Gc

LCIE 05 ATEX 6155 X

$-40\text{ °C} \leq T_{\text{amb}} \leq +80\text{ °C}$

WARNING – DO NOT CONNECT OR DISCONNECT WHEN  
ENERGIZED

Reduced marking:

PCB Piezotronics Inc. or IMI Sensors or IMI

Type : ... <sup>(1)</sup>

Serial number : ...

Year of construction : ...

 Ex II 3 G

Ex ec IIC T4 Gc

T<sub>a</sub> = 80 °C

LCIE 05 ATEX 6155 X

<sup>(1)</sup> See the Range Details above

The equipment shall also bear the usual marking required by the product standards applying to such equipment under the manufacturer responsibility.

**13 CONDITIONS PARTICULIERES D'UTILISATION**

- Gamme de température ambiante de fonctionnement :  
-40 °C à +80 °C.
- L'appareil doit uniquement être connecté à une source externe délivrant au maximum une tension de 30 V d.c. et une puissance de 1 Watt.
- La protection contre les transitoires doit être fournie à un niveau défini ne dépassant pas 140 % de la valeur de crête de la tension assignée aux bornes d'alimentation vers l'appareil.
- Le montage du capteur dans une installation doit être effectué de telle sorte que le corps métallique du capteur et le blindage du câble soient reliés de manière fiable à la terre du système.

**SPECIFIC CONDITIONS OF USE**

Ambient operating temperature range:  
-40 °C up to +80 °C.

The transducer shall be connected to an external power supply delivering a maximum of 30 V d.c. and 1 W.

Transient protection shall be provided that is set at a level not exceeding 140 % of the peak rated voltage value at the supply terminals to the device.

The mounting of the sensor in an installation must be carried out in such a way that the sensor metallic body and cable shield are reliably connected to the system earth.



- e. Pour les capteurs avec connecteur intégré :  
Le connecteur mâle ou femelle homologue fourni par l'utilisateur final doit être conforme à toutes les clauses applicables des normes EN 60079-0 et EN 60079-7. Un degré de protection IP54 minimum selon la norme IEC 60079-0 doit être assuré.  
Le connecteur homologue ne doit pas être connecté ou déconnecté sous tension.
- f. Pour les capteurs avec conducteurs volants :  
Les conducteurs volants doivent être convenablement protégés contre les chocs et doivent être connectés dans une enveloppe dûment certifiée ou dans une zone sûre. L'installation doit garantir qu'aucune force de traction ne sera appliquée aux conducteurs.
- g. Pour les capteurs avec coude de conduit:  
L'utilisateur devra utiliser un dispositif d'entrée certifié « Ex e » à l'entrée du coude tout en respectant les exigences d'installation de la norme EN 60079-14.  
Déconnecter le capteur du circuit d'alimentation avant d'ouvrir le coude de conduit.  
Le démontage du capteur de son coude de conduit n'est pas autorisé.
- h. **AVERTISSEMENT – NE PAS CONNECTER OU DECONNECTER SOUS TENSION**
- i. L'équipement doit être connecté conformément aux instructions du fabricant.

For sensor with integral connector:  
The mating connector provided by the end user shall be in accordance with all applicable clauses of EN 60079-0 and EN 60079-7 for a zone 2 application. A minimum degree of protection IP54 according to EN 60079-0 shall be ensured.

The mating connector shall not be connected or disconnected when energized.

For sensors with flying leads:  
The flying leads shall be suitably protected from impact and shall be terminated within a suitably certified enclosure or in safe area. The installation shall guarantee that no pulling force will be applied to the leads.

For sensors fitted with a capped conduit elbow:  
The user shall use an "Ex e" certified entry device at the capped elbow's entry while respecting the installation requirements of EN 60079-14.  
Disconnect the device from supply circuit before opening the capped conduit elbow.  
The disassembling of the sensor from its capped elbow is not allowed.

**WARNING – DO NOT CONNECT OR DISCONNECT WHEN ENERGIZED**

The equipment must be connected according to the instructions of the manufacturer.

#### 14 EXIGENCES ESSENTIELLES DE SANTE ET DE SECURITE

Couvertes par les normes listées au point 8.

#### ESSENTIAL HEALTH AND SAFETY REQUIREMENTS

Covered by standards listed at 8.

#### 15 DOCUMENTS DESCRIPTIFS

N°	Description	Reference	Rev.	Date	Page(s)
1.	Technical file	64777	A	2023-01-26	49
2.	Instructions For Use	32836	--	--	--

#### DESCRIPTIVE DOCUMENTS

#### 16 INFORMATIONS COMPLEMENTAIRES

##### Essais individuels

Conformément au paragraphe 7.1 de la norme EN 60079-7, chaque produit fabriqué doit être soumis à un essai de rigidité diélectrique à 500 V c.a. pendant 1 minute. Alternativement, le test peut être effectué à 600 V c.a. pendant 100 ms. Aucun claquage ne doit se produire.

#### ADDITIONAL INFORMATION

##### Routine tests

In accordance with clause 7.1 of standard EN 60079-7, each product manufactured shall be subjected to a dielectric strength test at 500 V a.c. for 1 minute. Alternatively the test may be carried out at 600 V a.c. for 100 ms. No breakdown shall occur.

#### 17 DETAILS DES MODIFICATIONS DE L'ATTESTATION

Version 00 : Version initiale.  
2005-12-07

#### DETAILS OF CERTIFICATE CHANGES

Issue 00: Initial issue.

1 Version : 03

LCIE 05 ATEX 6155 X

Issue : 03

Version 01 :  
2007-08-02

- Mise à jour normative selon les normes EN 60079-0:2006 et EN 60079-15:2005.

Version 02 :  
2018-07-11

- Mise à jour normative selon les normes EN 60079-0:2012 + A11:2013 et EN 60079-15:2010.
- Distinction entre le nom du fabricant (PCB Piezotronics Inc.) et le nom de la marque commerciale (IMI Sensors ou IMI).
- Mise à jour de la nomenclature des modèles.

Version 03 :

- Mise à jour normative selon les normes EN IEC 60079-0:2018 et EN 60079-7:2015 + A1:2018.
- Mise à jour de la désignation du type pour notamment introduire les capteurs « Modifiés » (M) sur demande spéciale du client (aucun impact sur les modes de protection).
- Mise à jour des conditions particulières d'utilisation.

Issue 01: • Normative update according to EN 60079-0:2006 and EN 60079-15:2005 standards.

Issue 02: • Normative update according to EN 60079-0:2012+A11:2013 and EN 60079-15:2010 standards.

- Distinction between the name of the manufacturer (PCB Piezotronics Inc.) and the trademark (IMI Sensors or IMI).
- Update of the nomenclature of the models.

Issue 03: • Normative update according to EN IEC 60079-0:2018 and EN 60079-7:2015 + A1:2018.

- Update of the type designation to notably introduce "Modified" sensors (M) for customer special request (no impact on the types of protection).
- Update of Specific Conditions of Use.



LCIE

# ATTESTATION D'EXAMEN DE TYPE TYPE EXAMINATION CERTIFICATE



1 Version : 02

LCIE 05 ATEX 6155 X

Issue : 02

- |  |  |
|--|--|
| <p>2 Appareil ou Système de Protection destiné à être utilisé en Atmosphères Explosibles</p> <p>3 Produit :<br/><b>Transmetteurs de vibration</b></p> <p>4 Fabricant :</p> <p>5 Adresse :</p> <p>6 Ce produit et ses variantes éventuelles acceptées sont décrits dans l'annexe de la présente attestation et dans les documents descriptifs cités en référence.</p> <p>7 Le LCIE certifie que ce produit est conforme aux Exigences Essentielles de Sécurité et de Santé pour la conception et la construction de produits destinés à être utilisés en atmosphères explosibles, données dans l'annexe II de la Directive.<br/>Les résultats des vérifications et essais figurent dans le(s) rapport(s) confidentiel(s) N° :</p> <p>8 Le respect des Exigences Essentielles de Sécurité et de Santé est assuré par la conformité à :</p> <p>9 Le signe « X » lorsqu'il est placé à la suite du numéro de l'attestation, indique que cet appareil est soumis aux conditions particulières d'utilisation, mentionnées dans l'annexe de cette attestation.</p> <p>10 Cette Attestation d'Examen de Type concerne uniquement la conception et la construction du produit spécifié.<br/>Des exigences supplémentaires de la directive sont applicables pour la fabrication et la fourniture du produit. Ces dernières ne sont pas couvertes par la présente attestation.</p> <p>11 Le marquage du produit est mentionné dans l'annexe de cette attestation.</p> | <p>Equipment or Protective System Intended for use in Potentially Explosive Atmospheres</p> <p>Product :<br/><b>Vibration transmitters</b></p> <p>Type: EX(M)64xYxx, EXTO(M)64xYxx, EXRV(M)64xYxx</p> <p>Manufacturer :<br/><b>PCB Piezotronics Inc.</b></p> <p>Address :<br/>3425 Walden Avenue<br/>DEPEW, NY 14043<br/>UNITED STATES of AMERICA</p> <p>This product any acceptable variation thereto is specified in the schedule to this certificate and the documents therein referred to.</p> <p>LCIE certifies that product has been found to comply with the Essential Health and Safety Requirements relating to the design and construction of products intended for use in potentially explosive atmospheres, given in Annex II to the Directive.<br/>The examination and test results are recorded in confidential report(s) N°:<br/>140596-682759</p> <p>Compliance with the Essential Health and Safety Requirements has been assured by compliance with :<br/>EN 60079-0:2012+A11:2013,<br/>EN 60079-15:2010</p> <p>If the sign "X" is placed after the certificate number, it indicates that the product is subject to the Specific Conditions of Use specified in the schedule to this certificate.</p> <p>This Type Examination Certificate relates only to the design and construction of the specified product.<br/>Further requirements of the Directive apply to the manufacturing process and supply of this product. These are not covered by this certificate.</p> <p>The marking of the product is specified in the schedule to this certificate.</p> |
|--|--|

Fontenay-aux-Roses, le 11 juillet 2018

Responsable de Certification  
Certification Officer

Julien Gauthier

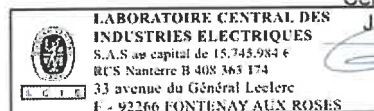

Seul le texte en français peut engager la responsabilité du LCIE. Ce document ne peut être reproduit que dans son intégralité, sans aucune modification. Il est établi en accord avec le référentiel de certification ATEX du LCIE. The LCIE's liability applies only on the French text. This document may only be reproduced in its entirety and without any change. It is issued in accordance with LCIE's ATEX Certification Rules.  
CERT-ATEX-FORM 05 Rev. 02

Page 1 of 4

LCIE

Laboratoire Central des Industries Electriques  
Une société de Bureau Veritas

33 Avenue du Général Leclerc  
92260 Fontenay-aux-Roses  
FRANCE

WWW.LCIE.FR

## 12 DESCRIPTION DU PRODUIT

L'appareil est un transmetteur de vibration intégrant un cristal piézoélectrique, un traitement électronique du signal et un connecteur ou un câble intégré ou des fils volants pour l'interface externe. Le signal délivré est un courant de sortie dans la plage 4-20mA correspondant au niveau de vibration.

Les appareils de type EXTO sont équipés d'un capteur de température intégré. L'appareil, type EXRV, délivre une sortie de vibration brute dans la plage 0-2.5VAC

Les boîtiers des têtes de capteur sont réalisés en acier inoxydable de plusieurs formes, en fonction du type. Les connexions externes peuvent être effectuées par connecteur ou câble blindé ou fils volants selon le type.

Équipement disponible en version métrique (type avec M).

Paramètres électriques :

Tension maximum d'entrée  $U_{max}$  : 30V  
Puissance maximum  $P_{max}$  : 1W

## DESCRIPTION OF PRODUCT

The apparatus is a vibration transmitter integrating a piezoelectric crystal, an electronic signal processing and a connector or a cable or flying leads for external interface. The delivered signal is an output current in the range 4-20mA corresponding to vibration level.

Apparatus, type EXTO, are provided with an integrated temperature sensor. Apparatus, type EXRV, delivers raw vibration output in the range 0-2.5VAC

Sensor heads are made of stainless steel housings with several shapes, depending on the type. External connections can be done by connector or shield cable or flying leads depending on the type.

Apparatus is available in metric version (type with M).

Electrical parameters:

Maximum input voltage  $U_{max}$  : 30V  
Maximum power  $P_{max}$  : 1W

## DETAIL DE LA GAMME

## RANGE DETAILS

## Types et caractéristiques / Types and characteristics

EX(M)64xA0y, EX(M)64xB0y avec connecteur / with connector.

EX(M)64xA1y, EX(M)64xA6y, EX(M)64xB1y, EX(M)64xB6y avec câble / with cable.

EXTO(M)64xA3y, EXTO(M)64xB3y avec capteur de température et Connecteur / with temperature sensor and connector.

EXTO(M)64xA1y, EXTO(M)64xA6y, EXTO(M)64xB1y, EXTO(M)64xB6y avec capteur de température et câble / with temperature sensor and cable.

EXRV(M)64xA0y, EXRV(M)64xB0y avec sortie vibration brute et connecteur / with raw vibration output and connector.

EXRV(M)64xA1y, EXRV(M)64xA6y, EXRV(M)64xB1y, EXRV(M)64xB6y avec sortie vibration brute et câble / with raw vibration output and cable.

EX(M)64xB7y avec fils volants / with flying leads.

EXTO(M)64xB7y avec capteur de température et fils volants / with temperature sensor and flying leads.

EXRV(M)64xB7y avec sortie vibration brute et fils volants / with raw vibration output and flying leads.

Note: la lettre M indique un équipement en version métrique. Les lettres x et y sont des variables du type (valeurs de 0 à 9).

Note: M letter indicates apparatus in metric version. Letters x and y are variable digits of the type (values between 0 and 9).

## MARQUAGE

Le marquage du produit doit comprendre :

Marquage complet :

PCB Piezotronics Inc. ou IMI Sensors ou IMI

Adresse : ...

Type : ...

Numéro de fabrication : ...

Année de fabrication : ...

⊕ II 3 G

Ex nA IIC T4 Gc

LCIE 05 ATEX 6155 X

-40°C ≤ Tamb ≤ +80°C

AVERTISSEMENT – NE PAS SEPARER SOUS TENSION

## MARKING

The marking of the product shall include the following :

Full marking :

PCB Piezotronics Inc. or IMI Sensors or IMI

Address: ...

Type : ...

Serial number: ...

Year of construction: ...

⊕ II 3 G

Ex nA IIC T4 Gc

LCIE 05 ATEX 6155 X

-40°C ≤ Tamb ≤ +80°C

WARNING – DO NOT SEPARATE WHEN ENERGIZED

#### MARQUAGE (suite)

Le marquage du produit doit comprendre :

Marquage réduit :

PCB Piezotronics Inc. ou IMI Sensors ou IMI

Type : ...

N° de fabrication : ...

Année de fabrication : ...

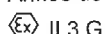
 Ex II 3 G

Ex nA IIC T4 Gc, Ta = 80°C

LCIE 05 ATEX 6155 X

L'appareil doit également comporter le marquage normalement prévu par les normes de construction qui le concernent sous la responsabilité du fabricant.

#### MARKING (continued)

The marking of the product shall include the following :

Reduced marking :

PCB Piezotronics Inc. or IMI Sensors or IMI

Type : ...

Serial number: ...

Year of construction: ...

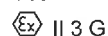
 Ex II 3 G

Ex nA IIC T4 Gc, Ta = 80°C

LCIE 05 ATEX 6155 X

The equipment shall also bear the usual marking required by the product standards applying to such equipment under the manufacturer responsibility.

#### 13 CONDITIONS PARTICULIERES D'UTILISATION

- a. Plage de température ambiante : -40°C à +80°C.
- b. L'appareil doit être connecté uniquement à une source externe de tension maximum 30V et de puissance maximum 1W.
- c. Le montage du produit dans une installation doit être effectué de telle sorte que le corps métallique du capteur et le blindage du câble soient reliés de manière fiable à la terre du système.
- d. Pour l'installation finale, l'utilisateur devra prendre toutes les précautions nécessaires pour maintenir un degré de protection minimum IP54 de la connexion du capteur lors de son raccordement selon les préconisations de la norme EN 60079-14.
- e. L'appareil doit être raccordé conformément au manuel d'instruction.
- f. AVERTISSEMENT – NE PAS SEPARER SOUS TENSION

#### SPECIFIC CONDITIONS OF USE

Ambient temperature range: -40°C to +80°C.

The equipment must only be connected to an external source with 30V maximum voltage and maximum power 1W.

The mounting of the apparatus into an installation must be carried out in such a way that sensor metallic body and cable shield are reliably connected to the system earth.

For final installation, the user shall take all necessary precautions to maintain the minimum degree of protection IP54 of the sensor connection when connected according to the requirements of EN 60079-14 standard.

The apparatus must be connected according to instruction manual.

**WARNING – DO NOT SEPARATE WHEN ENERGIZED**

#### 14 EXIGENCES ESSENTIELLES DE SANTE ET DE SECURITE

Couvertes par les normes listées au point 8.

#### ESSENTIAL HEALTH AND SAFETY REQUIREMENTS

Covered by standards listed at 8.

#### 15 DOCUMENTS DESCRIPTIFS

N°	Description	Reference	Rev.	Date	Page(s)
1.	Notice d'instructions / <i>Instructions notice</i>	32836	-	-	3
2.	Dossier technique / <i>Technical file</i>	64777	NR	2018/06/28	42

#### DESCRIPTIVE DOCUMENTS

#### 16 INFORMATIONS COMPLEMENTAIRES

**Essais individuels**

Chaque appareil doit être soumis au test de rigidité diélectrique suivant le paragraphe 23.2.1 de la norme EN 60079-15:2010. La tension de test doit être appliquée entre les signaux électriques actifs et l'enveloppe.

#### ADDITIONAL INFORMATION

**Routine tests**

Each equipment shall be submitted to the dielectric strength test according to the clause 23.2.1 of EN 60079-15:2010. Test voltage shall be applied between active electrical signals and the enclosure.

Seul le texte en français peut engager la responsabilité du LCIE. Ce document ne peut être reproduit que dans son intégralité, sans aucune modification. Il est établi en accord avec le référentiel de certification ATEX du LCIE. The LCIE's liability applies only on the French text. This document may only be reproduced in its entirety and without any change. It is issued in accordance with LCIE's [ATEX Certification Rules](#).  
CERT-ATEX-FORM 05 Rev. 02



# ATTESTATION D'EXAMEN DE TYPE - ANNEXE

## TYPE EXAMINATION CERTIFICATE - SCHEDULE

1 Version : 02

LCIE 05 ATEX 6155 X

Issue : 02

### 16 INFORMATIONS COMPLEMENTAIRES (suite)

En accord avec l'Article 41 de la Directive 2014/34/UE, les attestations d'examen de type mentionnant la Directive 94/9/CE émises avant la date d'application de la Directive 2014/34/UE (20 avril 2016) peuvent être considérées comme émises en accord avec la Directive 2014/34/UE. Les nouvelles versions de ces attestations peuvent conserver le numéro de l'attestation d'origine émise avant le 20 avril 2016.

### 17 DETAILS DES MODIFICATIONS

- Version 00 : Version initiale  
2005/12/07
- Version 01 : Mise à jour normative suivant les normes  
2007/08/02 EN 60079-0 : 2006 et EN 60079-15 : 2005.
- Version 02 : - Mise à jour normative suivant les normes  
EN 60079-0:2012+A11:2013 et EN 60079-15 :2010,  
- Distinction entre le nom du fabricant (PCB Piezotronics Inc) et le nom de la marque commerciale (IMI Sensors ou IMI),  
- Mise à jour de la nomenclature des modèles.

### ADDITIONAL INFORMATION (continued)

In accordance with Article 41 of Directive 2014/34/EU, Type Examination Certificates referring to Directive 94/9/EC that were in existence prior to the date of application of Directive 2014/34/EU (20 April 2016) may be referenced as if they were issued in accordance with Directive 2014/34/EU. New issues of such certificates may continue to bear the original certificate number issued prior to 20 April 2016.

### DETAILS OF CHANGES

- Issue 00: Initial issue.  
2005/12/07
- Issue 01: Normative update according to EN 60079-0:  
2007/08/02 2006 and EN 60079-15: 2005 standards.
- Issue 02: - Normative update according to EN 60079-0:2012+A11:2013 and EN 60079-15:2010 standards,  
- Distinction between the name of manufacturer (PCB Piezotronics Inc.) and the trademark (IMI Sensors or IMI),  
- Update of the nomenclature of the models.

Seul le texte en français peut engager la responsabilité du LCIE. Ce document ne peut être reproduit que dans son intégralité, sans aucune modification. Il est établi en accord avec le [référentiel de certification ATEX](#) du LCIE. *The LCIE's liability applies only on the French text. This document may only be reproduced in its entirety and without any change. It is issued in accordance with LCIE's [ATEX Certification Rules](#).*

Page 4 of 4

LCIE

Laboratoire Central des Industries Electriques  
Une société de Bureau Veritas

33 Avenue du Général Leclerc  
92260 Fontenay-aux-Roses  
FRANCE

WWW.LCIE.FR



LCIE



- 1 AVENANT D'ATTESTATION D'EXAMEN CE DE TYPE**
- 2 Appareil ou système de protection** destiné à être utilisé en atmosphères explosibles (**Directive 94/9/CE**)
- 3** Numéro de l'avenant :  
**LCIE 05 ATEX 6155 X / 01**
- 4** Appareil ou système de protection :  
Capteurs de vibration  
Type : EX64..., EXTO64..., EXVR64...
- 5** Demandeur : I.M.I.
- 15 DESCRIPTION DE L'AVENANT**  
Mise à jour normative selon les normes EN 60079-0 (2006) et EN 60079-15 (2005).  
Les résultats des vérifications et essais figurent dans le rapport confidentiel N° 60058689/559762  
Paramètres spécifiques du ou des modes de protection concerné(s) :  
Inchangés  
Le marquage doit être modifié comme suit :  
Ex nL IIC T4  
Ex nA IIC T4 (pour EX64xB7y, EXTO64xB7y, EXRV64xB7y)
- 16 DOCUMENTS DESCRIPTIFS**  
Dossier de certification N° 27867 Rév. A du 27/06/2007. Ce dossier comprend 18 rubriques (37 pages).  
Dossier de certification N° 28771 Rév. A du 27/06/2007. Ce dossier comprend 12 rubriques (28 pages).
- 17 CONDITIONS SPECIALES POUR UNE UTILISATION SURE**  
Inchangées
- 18 EXIGENCES ESSENTIELLES DE SECURITE ET DE SANTE**  
Conformité aux normes européennes EN 60079-0 (2006) et EN 60079-15 (2005).
- 19 VERIFICATIONS ET ESSAIS INDIVIDUELS**  
Néant

- 1 SUPPLEMENTARY EC TYPE EXAMINATION CERTIFICATE**
- 2 Equipment or protective system** intended for use in potentially explosive atmospheres (**Directive 94/9/EC**)
- 3** Supplementary certificate number :  
**LCIE 05 ATEX 6155 X / 01**
- 4** Equipment or protective system :  
Vibration sensors  
Type : EX64..., EXTO64..., EXVR64...
- 5** Applicant : I.M.I.
- 15 DESCRIPTION OF THE SUPPLEMENTARY CERTIFICATE**  
Normative update according to EN 60079-0 (2006) and EN 60079-15 (2005) standards.  
The examination and test results are recorded in confidential report N° 60058689/559762  
Specific parameters of the mode(s) of protection concerned:  
Unchanged  
The marking shall be modified as follows :  
Ex nL IIC T4  
Ex nA IIC T4 (for EX64xB7y, EXTO64xB7y, EXRV64xB7y)
- 16 DESCRIPTIVE DOCUMENTS**  
Certification file N° 27867 Rev. A dated 27/06/2007. This file includes 18 items (37 pages).  
Certification file N° 28771 Rév. A dated 27/06/2007. This file includes 12 items (28 pages).
- 17 SPECIAL CONDITIONS FOR SAFE USE**  
Unchanged
- 18 ESSENTIAL HEALTH AND SAFETY REQUIREMENTS**  
Conformity to the European standards EN 60079-0 (2006) and EN 60079-15 (2005).
- 19 ROUTINE VERIFICATIONS AND TESTS**  
None

Fontenay-aux-Roses, le 2 août 2007

Le responsable de certification ATEX  
ATEX certification manager



  
Henri CERVELLO

Seul le texte en français peut engager la responsabilité du LCIE. Ce document ne peut être reproduit que dans son intégralité, sans aucune modification.  
The LCIE's liability applies only on the French text. This document may only be reproduced in its entirety and without any change.

Page 1 sur 1

01A-Annexe III\_CE\_typ\_app\_av - rev1.DOC

LCIE  
Laboratoire Central  
des Industries Electriques  
Une société de Bureau Veritas  
33, av. du Général Leclerc  
BP 8  
92200 Fontenay-aux-Roses cedex  
France

Tél : +33 1 40 95 60 60  
Fax : +33 1 40 95 86 56  
contact@lcie.fr  
www.lcie.fr

Société Anonyme  
au capital de 15 745 984 €  
RCS Nanterre B 408 363 174



LCIE

## 1 ATTESTATION D'EXAMEN DE TYPE

2 Appareils et systèmes de protection destinés à être utilisés en atmosphères explosibles  
Directive 94/9/CE

3 Numéro de l'attestation d'examen de type  
LCIE 05 ATEX 6155 X

4 Appareil ou système de protection :  
Capteurs de vibrations  
Type : EX64...,EXTO64...,EXRV64 (voir page suivante)

5 Demandeur : I.M.I. (Industrial Monitoring Instrumentation)

6 Adresse : A PCB PIEZOTRONICS DIVISION  
3425 Walden Avenue  
Depew, New York 14043  
U.S.A.

7 Cet appareil ou système de protection et ses variantes éventuelles acceptées est décrit dans l'annexe de la présente attestation et dans les documents descriptifs cités en annexe.

8 Le LCIE certifie que cet appareil ou système de protection est conforme aux exigences essentielles en ce qui concerne la sécurité et la santé pour la conception et la construction d'appareils et de systèmes de protection destinés à être utilisés en atmosphères explosibles, données dans l'annexe II de la directive. Les vérifications et épreuves figurent dans nos rapports confidentiels n° 60040901/540946/2.

9 Le respect des exigences essentielles en ce qui concerne la sécurité et la santé est assuré par la conformité aux documents suivants :

-EN 50021 (1999)

10 Le signe X lorsqu'il est placé à la suite du numéro de l'attestation, indique que ce matériel ou système de protection est soumis aux conditions spéciales pour une utilisation sûre, mentionnées dans l'annexe de la présente attestation.

11 Cette attestation d'examen de type concerne uniquement la conception et la construction de l'appareil ou du système de protection spécifié, conformément à la directive 94/9/CE. Des exigences supplémentaires de cette directive sont applicables pour la fabrication et la fourniture de l'appareil ou du système de protection.

12 Le marquage de l'appareil ou du système de protection devra comporter, entre autres indications utiles, les mentions suivantes :

II 3 G  
EEx nL ou nA IIC T4

## 1 TYPE EXAMINATION CERTIFICATE

2 Equipment or protective system intended for use in potentially explosive atmospheres  
Directive 94/9/EC

3 Type Examination Certificate number  
LCIE 05 ATEX 6155 X

4 Equipment or protective system :  
Vibration sensors  
Type : EX64...,EXTO64...,EXRV64... (see following page)

5 Applicant : I.M.I. (Industrial Monitoring Instrumentation)

6 Address : A PCB PIEZOTRONICS DIVISION  
3425 Walden Avenue  
Depew, New York 14043  
U.S.A.

7 This equipment or protective system and any acceptable variation thereto is specified in the schedule to this certificate and the documents therein referred to.

8 LCIE certifies that this equipment or protective system has been found to comply with the essential Health and Safety Requirements relating to the design and construction of equipment and protective system intended for use in potentially explosive atmospheres, given in Annex II of the Directive. The examination and test results are recorded in confidential reports n° 60040901/540946/2.

9 Compliance with the Essential Health and Safety Requirements has been assured by compliance with :

-EN 50021 (1999)

10 If the sign X is placed after the certificate number, it indicates that the equipment or protective system is subject to special conditions for safe use specified in the schedule to this certificate.

11 This type examination certificate relates only to the design and construction of this specified equipment or protective system in accordance with the Directive 94/9/EC. Further requirements of the Directive applies to the manufacture and supply of this equipment or protective system.

12 The marking of the equipment or protective system shall include the following :

II 3 G  
EEx nL or nA IIC T4

Fontenay-aux-Roses, le 7 décembre 2005

Le Directeur de l'organisme certificateur  
Manager of the certification body

Henri CERVELLO  
Timbre sec / Dry seal

Seul le texte en français peut engager la responsabilité du LCIE. Ce document ne peut être reproduit que dans son intégralité, sans aucune modification  
The LCIE's liability applies only on the French text. This document may be reproduced in full and without any change

Page 1/3

LCIE

Laboratoire Central

des Industries Electriques

Une société de Bureau Veritas

33. av du Général Leclerc

BP 8

92266 Fontenay-aux-Roses cedex

France

Tél : +33 1 40 95 60 60

Fax : +33 1 40 95 86 56

contact@lcie.fr

www.lcie.fr

Société Anonyme

au capital de 15 745 984 €

RCS Nanterre B 408 363 174





LCIE

(A1) ANNEXE

(A1) SCHEDULE

(A2) ATTESTATION D'EXAMEN DE TYPE

(A2) TYPE EXAMINATION CERTIFICATE

LCIE 05 ATEX 6155 X

LCIE 05 ATEX 6155 X

(A3) Description de l'équipement ou du système de protection :

(A3) Description of Equipment or Protective System :

Capteurs de vibrations  
Type : EX64...,EXTO64...,EXRV64

Vibration sensors  
Type : EX64...,EXTO64...,EXRV64

Ce capteur est composé d'un ensemble piezo-cristal, d'une carte électronique et d'un connecteur ou un câble intégré.

This apparatus is made of a piezo-crystal assembly, an electronic board and a connector or an integrated cable.

Modèles concernés :  
EX64xB0y, EX64xB1y, EX64xB6y,  
EXTO64xB3y, EXTO64xB1y, EXTO64xB6y,  
EXRV64xB0y, EXRV64xB1y, EXRV64xB6y,  
EX64xB7y, EXTO64xB7y, EXRV64xB7y  
EX64xA0y, EX64xA1y, EX64xA6y,  
EXTO64xA3y, EXTO64xA1y, EXTO64xA6y,  
EXRV64xA0y, EXRV64xA1y, EXRV64xA6y

Models concerned :  
EX64xB0y, EX64xB1y, EX64xB6y  
EXTO64xB3y, EXTO64xB1y, EXTO64xB6y,  
EXRV64xB0y, EXRV64xB1y, EXRV64xB6y,  
EX64xB7y, EXTO64xB7y, EXRV64xB7y  
EX64xA0y, EX64xA1y, EX64xA6y,  
EXTO64xA3y, EXTO64xA1y, EXTO64xA6y,  
EXRV64xA0y, EXRV64xA1y, EXRV64xA6y

Le marquage est le suivant :

Marking is as follow :

I.M.I. Adresse : ...  
Type : EX... (1)  
N° de fabrication : ... Année de fabrication : ...  
II 3 G  
EEx nL IIC T4  
EEx nA IIC T4 (types EX64xB7y, EXTO64xB7y, EXRV64xB7y)  
LCIE 05 ATEX 6155 X  
T.amb. : - 40°C à + 80°C

I.M.I. Address : ...  
Type : EX... (1)  
Serial number : ... Year of manufacturing : ...  
II 3 G  
EEx nL IIC T4  
EEx nA IIC T4 (types EX64xB7y, EXTO64xB7y, EXRV64xB7y)  
LCIE 05 ATEX 6155 X  
T.amb. : - 40°C to + 80°C

(1) Suivant le modèle

(1) According to the model

Le matériel devra également comporter le marquage normalement prévu par les normes de construction du matériel électrique concerné.

The equipment must also bear the usual marking required by the manufacturing standards applying to such equipments.

Paramètres électriques relatifs à la sécurité :

Electrical parameters relative to safety :

Modèle / Model	Ui (V)	Ii (mA)	Pi (W)	Ci (nF)	Li (µH)
EX64xA0x, EX64xB0y	30	100	1	0	1,06
EX64xA1y, EX64xA6y, EX64xB1y, EX64xB6y	30	100	1	61	306
EXTO64xA3y, EXTO64xB3y	28	120	1	0	1,06
EXTO64xA1y, EXTO64xA6y, EXTO64xB1y, EXTO64xB6y	28	120	1	61	306
EXRV64xA0y, EXRV64xB0y	28	120	1	0	121,06
EXRV64xA1y, EXRV64xA6y, EXRV64xB1y, EXRV64xB6y	28	120	1	61	426
EX64xB7y	12 à/to 30				
EXTO64xB7y, EXRV64xB7y	12 à/to 30				

Handwritten signature



L C I E

(A1) **ANNEXE**

(A1) **SCHEDULE**

(A2) **ATTESTATION D'EXAMEN DE TYPE**

(A2) **TYPE EXAMINATION CERTIFICATE**

**LCIE 05 ATEX 6155 X (suite)**

**LCIE 05 ATEX 6155 X (continued)**

(A4) Documents descriptifs :

Dossier technique N° 28771 Rév. NR du 10/10/2005.  
Ce document comporte 12 rubriques (28 pages).

Dossier technique N° 27867 Rév. NR du 10/10/2005.  
Ce document comporte 18 rubriques (37 pages).

(A5) Conditions spéciales pour une utilisation sûre :

Les paramètres électriques d'alimentation ne doivent pas excéder les valeurs mentionnées au paragraphe (A3).

Température ambiante d'utilisation : - 40°C à + 80°C.

(A6) Exigences essentielles en ce qui concerne la sécurité et la santé :

Conformité au norme européenne EN 50021 (1999).

Vérifications et épreuves individuelles :

L'appareil est dispensé d'épreuve individuelle.

(A4) Descriptive documents :

Technical file No. 28771 Rev. NR dated 10/10/2005.  
This file includes 12 items (28 pages).

Technical file No. 27867 Rev. NR dated 10/10/2005.  
This file includes 18 items (37 pages).

(A5) Special conditions for safe use :

The supply electrical parameters shall not exceed the values mentioned in paragraph (A3).

Operating ambient temperature : - 40°C to + 80°C.

(A6) Essential Health and Safety Requirements :

Conformity to the European standard EN 50021 (1999).

Individual examinations and tests :

The equipment is not submitted to routine test.



**СЕРТИФИКАТ СООТВЕТСТВИЯ**

№ ЕАЭС RU C-US.AA87.B.00217/19

Серия **RU** № **0124866**



**ОРГАН ПО СЕРТИФИКАЦИИ** Орган по сертификации взрывозащищенного и рудничного оборудования (ОС ЦСВЭ) Общества с ограниченной ответственностью «Центр по сертификации взрывозащищенного и рудничного оборудования» (ООО «НАНИО ЦСВЭ»). Адрес места нахождения юридического лица: Россия, 140004, Московская область, Люберецкий район, город Люберцы, поселок ВУГИ, АО «Завод «ЭКОМАШ», литера В, Объект 6, этаж 3, офис 26. Адрес места осуществления деятельности в области аккредитации: Россия, 140004, Московская область, Люберецкий район, город Люберцы, поселок ВУГИ, АО «Завод «ЭКОМАШ», Литера В, Объект 6, этаж 3, офисы 26/3, 26/4, 26/5, 27/6, 30/1, 32. Аттестат № RA.RU.11AA87 от 20.07.2015 г. Телефон: +7 (495) 558-83-53, +7 (495) 558-82-44. Адрес электронной почты: ccve@ccve.ru

**ЗАЯВИТЕЛЬ** Общество с ограниченной ответственностью «Альфатех». Адрес места нахождения юридического лица: Россия, 125009, Москва, Малый Гнезниковский переулок, дом № 12, помещение I, комната 4. Адрес места осуществления деятельности: Россия, 127495, Москва, Долгопрудненское шоссе, дом № 3, Технопарк «Физтехпарк». ОГРН: 1167746393792. Телефон: +7 (495) 642-49-14. Адрес электронной почты: info@alphatechgroup.ru

**ИЗГОТОВИТЕЛЬ** PCB Piezotronics, Inc  
Адрес места нахождения юридического лица и адрес места осуществления деятельности по изготовлению продукции: 3425 Walden Av., Depew, NY 14043, США

**ПРОДУКЦИЯ** Пьезоэлектрические преобразователи, вибропереключатели, предусилители с Ex-маркировкой согласно приложению (см. бланки №№ 0621345, 0621346, 0621347). Документы, в соответствии с которыми изготовлены изделия – см. приложение, бланк № 0621344. Серийный выпуск.

КОД ТН ВЭД ЕАЭС 9031 80 3800, 9026 20 2000, 8517 69 9000

СООТВЕТСТВУЕТ ТРЕБОВАНИЯМ  
ТР ТС 012/2011 «О безопасности оборудования для работы во взрывоопасных средах».

**СЕРТИФИКАТ СООТВЕТСТВИЯ ВЫДАН НА ОСНОВАНИИ**  
Протокола испытаний № 235.2019-Т от 11.09.2019 Испытательной лаборатории технических устройств Автономной некоммерческой организации «Национальный испытательный и научно-исследовательский институт оборудования для взрывоопасных сред» ИЛ Ex TU (аттестат № РОСС RU.0001.21MШ19 от 16.10.2015); Акта анализа состояния производства № 35-А/19 от 14.03.2019 Органа по сертификации взрывозащищенного и рудничного оборудования (ОС ЦСВЭ) Общества с ограниченной ответственностью «Центр по сертификации взрывозащищенного и рудничного оборудования» (ООО «НАНИО ЦСВЭ») (аттестат № RA.RU.11AA87 выдан 20.07.2015); Документов, представленных заявителем в качестве доказательства соответствия продукции требованиям ТР ТС 012/2011 (см. приложение, бланк № 0621344).  
Схема сертификации – 1с.

**ДОПОЛНИТЕЛЬНАЯ ИНФОРМАЦИЯ**  
Перечень стандартов, применяемых на добровольной основе для соблюдения требований ТР ТС 012/2011 (см. приложение, бланк № 0621344). Условия и срок хранения указаны в эксплуатационной документации. Назначенный срок службы – 10 лет.

СРОК ДЕЙСТВИЯ С 13.09.2019 ПО 12.09.2024  
ВКЛЮЧИТЕЛЬНО

Руководитель (уполномоченное лицо) органа по сертификации

(подпись)

Залогин Александр Сергеевич

(Ф.И.О.)

Эксперт (эксперт-аудитор) (эксперты (эксперты-аудиторы))

(подпись)

М.П. Рафалович Борис Александрович

(Ф.И.О.)

ПРИЛОЖЕНИЕ

К СЕРТИФИКАТУ СООТВЕТСТВИЯ № ЕАЭС RU C-US.AA87.B.00217/19 Лист 1

Серия RU № 0621344

**I. ПЕРЕЧЕНЬ СТАНДАРТОВ, ПРИМЕНЯЕМЫХ НА ДОБРОВОЛЬНОЙ ОСНОВЕ  
ДЛЯ СОБЛЮДЕНИЯ ТРЕБОВАНИЙ ТР ТС 012/2011 «О БЕЗОПАСНОСТИ ОБОРУДОВАНИЯ  
ДЛЯ РАБОТЫ ВО ВЗРЫВООПАСНЫХ СРЕДАХ»**

Обозначение стандартов	Наименование стандартов
ГОСТ 31610.0-2014 (IEC 60079-0:2011)	Взрывоопасные среды. Часть 0. Оборудование. Общие требования
ГОСТ IEC 60079-1-2011	Взрывоопасные среды. Часть 1. Оборудование с видом взрывозащиты «взрывонепроницаемые оболочки «d»
ГОСТ 31610.11-2014 (IEC 60079-11:2011)	Взрывоопасные среды. Часть 11. Оборудование с видом взрывозащиты «искробезопасная электрическая цепь «i»
ГОСТ 31610.15-2012/МЭК 60079-15:2005	Электрооборудование для взрывоопасных газовых сред. Часть 15. Конструкция, испытания и маркировка электрооборудования с видом защиты «п»

**II. ДОКУМЕНТЫ, ПРЕДСТАВЛЕННЫЕ ЗАЯВИТЕЛЕМ В КАЧЕСТВЕ ДОКАЗАТЕЛЬСТВА  
СООТВЕТСТВИЯ ПРОДУКЦИИ ТРЕБОВАНИЯМ ТР ТС 012/2011**

Руководства по эксплуатации: № 750119 от 23.01.19, № 830119 от 23.01.19, № 940219 от 07.02.19, № 630119 от 22.01.19, № 610119 от 22.01.19, № 910219 от 07.02.19, № 950219 от 08.02.19, № 970219 от 08.02.19.  
Технические файлы: № 54202 от 02.02.2017, № 54204 от 02.02.2017, № 22438 С от 19.07.2012, № 62501 от 06.10.2016, № 33699 от 16.06.2016, № 56178 от 01.07.2016, № 70893 от 24.07.2019, № 54707 от 10.08.2016, № 48813 от 06.01.2011  
Чертежи: № 47912 от 31.03.2017, № 49038 от 31.03.2017.  
Перечень стандартов см. п. I.

**III. ДОКУМЕНТЫ, В СООТВЕТСТВИИ С КОТОРЫМИ ИЗГОТОВЛЕНА ПРОДУКЦИЯ**

Технические файлы: № 54202 от 02.02.2017, № 54204 от 02.02.2017, № 22438 С от 19.07.2012, № 62501 от 06.10.2016, № 33699 от 16.06.2016, № 56178 от 01.07.2016, № 70893 от 24.07.2019, № 54707 от 10.08.2016, № 48813 от 06.01.2011  
Чертежи: № 47912 от 31.03.2017, № 49038 от 31.03.2017

Руководитель (уполномоченное  
лицо) органа по сертификации

(подпись)

Эксперт (эксперт-аудитор)  
(эксперты (эксперты-аудиторы))

(подпись)



Залогин Александр Сергеевич  
(Ф.И.О.)

М.П.

Рафалович Борис Александрович  
(Ф.И.О.)

**ПРИЛОЖЕНИЕ**

**К СЕРТИФИКАТУ СООТВЕТСТВИЯ № ЕАЭС RU C-US.AA87.B.00217/19 Лист 2**

Серия **RU** № **0621345**

**1. НАЗНАЧЕНИЕ И ОБЛАСТЬ ПРИМЕНЕНИЯ**

Пьезоэлектрические преобразователи (далее – преобразователи) предназначены для контроля параметров вибрации, динамического давления и преобразования их в электрический сигнал.

Вибропереключатели предназначены для контроля уровня вибрации и защиты оборудования от повышенной вибрации.

Предусилители предназначены для преобразования зарядового сигнала в вольтовый.

Область применения - взрывоопасные зоны помещений и наружных установок согласно Ex-маркировке, ГОСТ IEC 60079-14-2013, регламентирующих применение во взрывоопасных средах.

**2. СТРУКТУРНОЕ ОБОЗНАЧЕНИЕ**

**2.1. Преобразователи 176ХУУ/МZZZ-АА**

X = от А до Z ревизия продукта, не влияющая на взрывозащиту

УУ = от 01 до 99 для индикации вариантов монтажа, диафрагмы, кабелей или разъемов

M = опционально для указания метрической длины кабеля

ZZZ = от 001 до 999 опционально для указания длины кабеля в футах: (не более 200 футов) или метрах: (не более 61 м)

AA = от 01 до 99 опционально для указания дробной длины кабеля в дюймах или сантиметрах, не влияющей на взрывозащиту

**2.2. Преобразователи 351abcd**

a – ревизия продукта, может быть: А,В,С,Д,Е,F,G,H,I,J,K,L или M, не влияющая на взрывозащиту

b – первая цифра вариации продукта, может быть: 0,1,2,3,4,5,6,7,8 или 9, не влияющая на взрывозащиту

c – вторая цифра вариации продукта, может быть: 0,1,2,3,4,5,6,7,8 или 9, не влияющая на взрывозащиту

d – третья цифра вариации продукта, может быть: 0,1,2,3,4,5,6,7,8,9 или отсутствует, не влияющая на взрывозащиту

**2.3 Преобразователи EX(TO)(M)602yzzz1aaa, EX(TO)(M)603yzzz/aaa, EX(TO)(M)606yzzz/aaa, EX(TO)(M)607yzzz/aaa, EX(TO)(M)608yzzz/aaa, EX(M)637XYYYZ, (M)638XYYYZ**

XX = TO (с температурным выходом), M (с метрической резьбой),

y = одна буква от А до Z, не влияющая на взрывозащиту

zzz = две или три цифры от 00 до 999, не влияющие на взрывозащиту

aaa = длина кабеля и/или тип разъема

**2.4 Предусилители EX682XYYY**

X – ревизия продукта (А,В ... М), не влияющая на взрывозащиту

YYY: параметры фильтрации, усиления, частотная характеристика, ... (от 1 до 999), не влияющие на взрывозащиту

**2.5 Преобразователи EX(RV)(TO)(M)64xухх, EX(RV)(TO)(M)649ухх, EX (RV)(TO) (M)686ухх**

XX = M (с метрической резьбой), TO (с температурным выходом), RV (с доп. вольтовым выходом).

Буквы х являются переменными цифрами (значения от 0 до 9), не влияющими на взрывозащиту

y = одна буква от А до Z, не влияющая на взрывозащиту

**2.6 Преобразователи EX (XX) 622yzzz / aaa, EX (XX) 623yzzz / aaa, EX (XX) 625yzzz / aaa, EX (XX) 628yzzz / aaa**

XX = HT (Высокотемпературная версия), M (с метрической резьбой), TO (с температурным выходом), VO (с выходом по скорости).

y = одна буква от А до Z, не влияющая на взрывозащиту

zzz = две или три цифры от 00 до 999, не влияющие на взрывозащиту

aaa = длина кабеля и/или тип разъема

**2.7 Вибропереключатели 685ухх**

Буквы х являются переменными цифрами (значения от 0 до 9), не влияющими на взрывозащиту

y = одна буква от А до Z, не влияющая на взрывозащиту

Руководитель (уполномоченное  
лицо) органа по сертификации

(подпись)

**Залогин Александр Сергеевич**  
(Ф.И.О.)

Эксперт (эксперт-аудитор)  
(эксперты (эксперты-аудиторы))

(подпись)

**Рафалович Борис Александрович**  
(Ф.И.О.)

## ПРИЛОЖЕНИЕ

К СЕРТИФИКАТУ СООТВЕТСТВИЯ № ЕАЭС RU C-US.AA87.B.00217/19 Лист 3

Серия **RU** № **0621346**

### 3. ОСНОВНЫЕ ТЕХНИЧЕСКИЕ ДАННЫЕ

3.1. Ех-маркировка: преобразователей 176XYU/MZZ-AA	0Ex ia IIC T660°C...T6 Ga X
преобразователей 351abcd	0Ex ia IIC T4 Ga X
вибропереключателей 685yxx	1Ex d IIB+H2 T4 Gb
преобразователей EX(TO)(M)602yzzz1aaa, EX(TO)(M)603yzzz/aaa, EX(TO)(M)606yzzz/aaa, EX(TO)(M)607yzzz/aaa, EX(TO)(M)608yzzz/aaa	2Ex nA IIC T4 Gc X или 0Ex ia IIC T4 Ga X
преобразователей EX(M)637XYUZY, (M)638XYUZY	0Ex ia IIC T4 Ga X или 2Ex nA IIC T4 Gc X
предусилителей EX682XYUZY	0Ex ia IIC T4 Ga X или 2Ex nA IIC T4 Gc X
EX(RV)(TO)(M)64хyxx, EX(RV)(TO)(M)649yxx, EX (RV)(TO) (M)686yxx	1Ex d IIC T4 Gb X или 1Ex d IIC T3 Gb X
преобразователей EX (XX) 622yzzz / aaa, EX (XX) 623yzzz / aaa, EX (XX) 625yzzz / aaa , EX (XX) 628yzzz / aaa	2Ex nA IIC T4 Gc X
3.2. Диапазон температур окружающей среды, °С,	
преобразователей 176XYU/MZZ-AA	от -70 до 650
преобразователей 351abcd	от -196 до 121
вибропереключателей 685yxx	от -25 до 60
преобразователей EX(TO)(M)602yzzz1aaa, EX(TO)(M)603yzzz/aaa, EX(TO)(M)606yzzz/aaa, EX(TO)(M)607yzzz/aaa, EX(TO)(M)608yzzz/aaa	от -54 до 121
преобразователей EX(M)637XYUZY, (M)638XYUZY	от -196 до 121
предусилителей EX682XYUZY	от -40 до 85
преобразователей EX(RV)(TO)(M)64хyxx, EX(RV)(TO)(M)649yxx, EX (RV)(TO) (M)686yxx	от -20 до 80
преобразователей EX (XX) 622yzzz / aaa, EX (XX) 623yzzz / aaa, EX (XX) 625yzzz / aaa , EX (XX) 628yzzz / aaa	от -54 до 121

### 3.3. Входные искробезопасные электрические параметры преобразователей, предусилителей:

Модель	U <sub>i</sub> , В	I <sub>i</sub> , мА	P <sub>i</sub> , Вт	C <sub>i</sub> , нФ	L <sub>i</sub> , мГн
преобразователей 176XYU/MZZ-AA	30	300	1	5	0,5
преобразователей 351abcd	28	200	1,2	61	305 мкГн
преобразователей EX(TO)(M)602yzzz1aaa, EX(TO)(M)603yzzz/aaa, EX(TO)(M)606yzzz/aaa, EX(TO)(M)607yzzz/aaa, EX(TO)(M)608yzzz/aaa	28	200	1	16,2 или 77,2 (с кабелем)	пренебрежимо мала или 305 мкГн (с учетом кабеля 305м)
преобразователей EX(M)637XYUZY, (M)638XYUZY	28	93	0,65	6,5	пренебрежимо мала
предусилителей EX682XYUZY	28	100	0,7	пренебрежимо мала	пренебрежимо мала

Руководитель (уполномоченное  
лицо) органа по сертификации

(подпись)

Эксперт (эксперт-аудитор)  
(эксперты (эксперты-аудиторы))

(подпись)

Залогин Александр Сергеевич

(Ф.И.О.)

М.П. Рафалович Борис Александрович

(Ф.И.О.)

## ПРИЛОЖЕНИЕ

К СЕРТИФИКАТУ СООТВЕТСТВИЯ № ЕАЭС RU C-US.AA87.B.00217/19 Лист 4

Серия RU № 0621347

### 3.4. Электрические параметры:

#### 3.4.1 вибропереключателей 685ухх

Напряжение питания, В 85-245 (AC), 24 (DC)  
Максимальный ток, mA 150

3.4.2 преобразователей EX(TO)(M)602yzzz/aaa, EX(TO)(M)603yzzz/aaa, EX(TO)(M)606yzzz/aaa, EX(TO)(M)607yzzz/aaa, EX(TO)(M)608yzzz/aaa, EX (XX) 622yzzz / aaa, EX (XX) 623yzzz / aaa, EX (XX) 625yzzz / aaa, EX (XX) 628yzzz / aaa

с Ex-маркировкой 2Ex nA IIC T4 Gc X:

Напряжение питания, В 28  
Максимальный ток, mA 200  
Мощность, Вт 1

#### 3.4.3 преобразователей EX(M)637XYYYZ, (M)638XYYYZ

Напряжение питания, В 18 – 28  
Максимальный ток, mA 1,6 – 20  
Мощность, Вт 0,5

#### 3.4.4 Предусилителей EX682XYYY

Напряжение питания, В 22 – 28  
Максимальный ток, mA 3,1 – 4,1  
Мощность, Вт 0,1

#### 3.4.5 преобразователей EX(RV)(TO)(M)64уххх, EX(RV)(TO)(M)649ухх, EX (RV)(TO) (M)686ухх

Напряжение питания, В 18 – 30  
Максимальный ток, mA 1,6 – 20  
Мощность, Вт 0,5

### 4. ОПИСАНИЕ КОНСТРУКЦИИ И СРЕДСТВ ОБЕСПЕЧЕНИЯ ВЗРЫВОЗАЩИЩЕННОСТИ

Преобразователи состоят из герметичного цилиндрического металлического корпуса, в котором размещается печатная плата и пьезокристаллический элемент. Сборка подключается к разъему или встроенному кабелю. На наружной поверхности корпуса преобразователя нанесена маркировка.

Вибропереключатели серии 685ухх выполнены в металлическом корпусе, внутри которого размещена электронная плата. На наружной поверхности корпуса нанесена маркировка.

Предусилители серии EX682XYYY выполнены в прямоугольном пластиковом корпусе с креплением на DIN рейку. Внутри корпуса размещена электронная плата. На корпусе размещен съемный клеммный блок. На наружной поверхности корпуса нанесена маркировка.

Подробное описание конструкции приведено в Руководствах по эксплуатации №750119 от 23.01.19, №830119 от 23.01.19, №940219 от 07.02.19, №630119 от 22.01.19, №610119 от 22.01.19, №910219 от 07.02.19, №950219 от 08.02.19, №970219 от 08.02.19

Взрывозащищенность преобразователей, вибропереключателей и предусилителей обеспечивается выполнением требований: ГОСТ 31610.15-2012/МЭК 60079-15:2005, ГОСТ 31610.0-2014 (IEC 60079-0:2011), ГОСТ IEC 60079-1-2011, ГОСТ 31610.11-2014 (IEC 60079-11:2011), в соответствии с Ex-маркировкой.

### 5. МАРКИРОВКА

Маркировка, наносимая на преобразователи, вибропереключатели и предусилители, включает следующие данные:

- товарный знак или наименование предприятия-изготовителя;
- серийный номер или номер партии;
- диапазон значений температур окружающей среды при эксплуатации;
- Ex-маркировку;
- специальный знак взрывобезопасности;
- наименование центра по сертификации и номер сертификата;
- предупредительные надписи;
- искробезопасные параметры

и другие данные, которые изготовитель должен отразить в маркировке, в соответствии с требованиями нормативной и технической документации.

### 6. СПЕЦИАЛЬНЫЕ УСЛОВИЯ ПРИМЕНЕНИЯ

5.1 Знак X, стоящий после Ex-маркировки, означает, что при эксплуатации преобразователей, вибропереключателей, предусилителей необходимо соблюдать следующие специальные условия:

- преобразователи, вибропереключатели, предусилители должны быть подключены к сертифицированному на соответствие требованиям ТР ТС 012/2011 источнику питания с соответствующей областью применения.

5.2 Свободные концы постоянно подсоединенного кабеля должны подключаться в сертифицированной на соответствие требованиям ТР ТС 012/2011 соединительной коробке или вне взрывоопасной зоны.

Специальные условия применения, обозначенные знаком X, отражены в сопроводительной документации, подлежащей обязательной поставке в комплекте с каждым изделием.

Внесение изменений в конструкцию изделий возможно только по согласованию с ОС ЦСВЭ в соответствии с требованиями ТР ТС 012/2011.

Руководитель (уполномоченное лицо) органа по сертификации

Эксперт (эксперт-аудитор) (эксперты (эксперты-аудиторы))

(подпись)

(подпись)



Залогин Александр Сергеевич

(ф.и.о.)

М.П. Рафалович Борис Александрович

(ф.и.о.)

**SIL Declaration of Conformity**  
Functional safety according to IEC 61508

Manufacturer: PCB Piezotronics  
3425 Walden Avenue  
Depew, NY 14043 USA

PCB Piezotronics declares as manufacturer, that the vibration transmitters:

- 640 Series – (XX)640yzzz/aaa (XX) Options include one or more of the following:
  - 641 Series – (XX)641yzzz/aaa
  - 642 Series – (XX)642yzzz/aaa
  - 643 Series – (XX)643yzzz/aaa
  - 645 Series – (XX)645yzzz/aaa
  - 646 Series – (XX)646yzzz/aaa
  - 647 Series – (XX)647yzzz/aaa
  - 648 Series – (XX)648yzzz/aaa
- EX – Approved for Hazardous Locations  
HT – High Temperature (257°F, 125°C)  
M – Metric Mounting Hardware  
RV – Dual Output (4-20 Vibration/Analog Acceleration)  
RVVO – Dual Output (4-20 Vibration/Analog Velocity)  
TO – Dual Output (Vibration/Temperature)
- Note: “yzzz” completes the model, “aaa” indicates cable length (if applicable)

Is hardware suitable for use in safety-instrumented systems according to IEC 61508, if the safety instructions and the following parameters are observed:

Parameter	64x Series – Connector or integral Cable*	64x Series - Terminal Block or Flying Leads*
SIL	2	2
Proof Test Interval (Annual)	8,760 h	8,760 h
Device Type	B	B
HFT	0	0
SFF	86.27%	86.12%
PFD <sub>AV</sub> <sup>1</sup>	1.255 x 10 <sup>-3</sup>	1.299 x 10 <sup>-3</sup>
λ <sub>du</sub> x 10 <sup>-6</sup>	0.3348	0.3469
SIL Capability (Low Demand Mode)	2	2
SIL Capability (Continuous Demand Mode)	2	2
MTTF <sup>2</sup>	24.4 y	24.4 y

1. The value comply with SIL 2 according to ISA S84.01  
2. According to Siemens SN29500 and Proven in Use data

\* With or without EX, HT, M, RV, RVVO, or TO Option(s)

The PCB sensor hardware is suitable for inclusion in Safety Instrumented Systems (SIS) that are designed using IEC 61511 (for the process industry sector), IEC 62061 (safety of machinery), EN 50129 (railway applications), and ISO 26262 (automotive industry).

Note: The use of SIL Hardware in specific safety standard application may apply different number of sequences or definitions to those in IEC 61508.

July 3, 2019

PCB Piezotronics Authorized Representative:

Carrie Termin  
Regulatory Affairs and Product Certification Specialist



**PCB PIEZOTRONICS, INC. — CORPORATE HEADQUARTERS**

3425 Walden Avenue, Depew, New York 14043-2495 USA

Phone: 716-684-0001 Fax: 716-684-0987

E-mail: info@pcb.com

Web site: www.pcb.com

**AS9100 and ISO9001 Certified  
ISO17025 Accredited**



# INTERTEK ASSURANCE SAFETY INTEGRITY LEVEL SUMMARY REPORT

## PCB SIL SENSOR RATING

**CLIENT NAME**

PCB Piezotronics, Inc.  
3425 Walden Ave  
Depew, NY 14043-2417

**REPORT NO**

103685042CSLT-001

**COMPILED BY**

Ashton D. Hainge, CFSP, PMP

**PROJECT NAME**

G103685042

**DATE**

16 November 2018

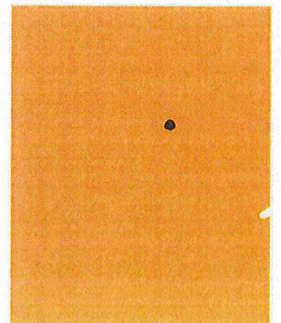
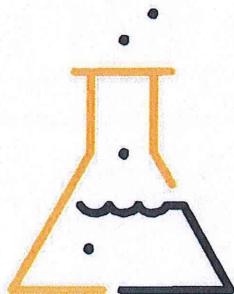



# PCB FUNCTIONAL SAFETY SIL SUMMARY AND RESULTS

## Summary

This summary report details results of the reliability analysis performed on the PCB Piezotronics 4-20 mA Output Velocity Sensor and 4-20 mA Output Acceleration Sensor model 64XYZZ Series. These results are based the following PCB Piezotronics documentation. Design changes from this documentation package would need to be evaluated for the impact on reliability characteristics.

1. Electrical schematic 23927-B
2. Electrical schematic 24297-E
3. BOM 21459-01-L
4. BOM 24297-01-209-100-G
5. Manual 640BXX

Reliability calculations were conducted at the component and circuit level using the methodology outlined in MIL-HDKB-217F. Product level failure parameters were then calculated in accordance the functional safety approach of IEC 61508-1:2010, IEC 61508-2:2010, IEC 61508-6:2010, and IEC 61508-7:2010.

## Results

The results from the FMEA are given below for the 4-20 mA Output Velocity Sensor and 4-20 mA Output Acceleration Sensor model 64XYZZ:

Name	Circular Connector	Terminal Block
Architecture	1001	1001
Proof test interval (Annual)	8,760 h	8,760 h
PFD <sub>avg</sub>	1.255x10 <sup>-3</sup>	1.299x10 <sup>-3</sup>
SFF	86.27%	86.12%
HFT	0	0
SIL Capability (Low Demand Mode)	2	2
SIL Capability (Continuous Demand Mode)	2	2
Architecture	1001	1001

**PCB Sensor Product Meets SIL 2 Capability**



Name		Results*
Safe Detected failure rate	$\lambda_{SD} \times 10^{-6}$	0.4937 (0.5117)
Safe Undetected failure rate	$\lambda_{SU} \times 10^{-6}$	0.3291 (0.3411)
Dangerous Detected failure rate	$\lambda_{DD} \times 10^{-6}$	1.2813 (1.2993)
Dangerous Undetected failure rate	$\lambda_{DU} \times 10^{-6}$	0.3348 (0.3468)
Average frequency of a dangerous failure on demand	$PFH \times 10^{-6}$	1255.0477 (1299.0000)

**Type B components: 64XYZZ Series (includes EX64XYZZ Series)**

The safety relevant parameter  $PFD_{avg}$  is in compliance with the corresponding requirements for SIL 2 according to IEC 61508<sup>1</sup>.

The safety relevant parameters HFT and SFF are in compliance with the corresponding requirements for SIL 1 according to IEC 61508.

The user should consider, that the hardware fault tolerance of all inspected devices is zero and that a single fault can lead to a dangerous failure.

Senior Consultant,

Ashton Hainge, Intertek  
CFSP, PMP

\*Note: Values are for Circular/Cylindrical connectors. Values for Terminal Block connectors are given in parenthesis.

<sup>1</sup> The assessment results described in this report only refer to the safety-related parameters  $PFD_{avg}$ , HFT, and SFF according to IEC 61508.

This report does not make any statements, that the manufacturer meets all other requirements of the above cited standards for hardware, software, documentation, management of functional safety, verification, and validation.

This report does not imply that the examined pressure sensors have been certified for functional safety by the assessor according to IEC 61508 or any other standards.

The sensors are only one part of a complete safety function. It is at the responsibility of the end-user to prepare and to apply an extensive reliability model, that brings out the complete safety function and that meets all requirements of the claimed SIL level according to IEC 61508.

## EU Declaration of Conformity PS053

*In Accordance with ISO/IEC 17050*

**Manufacturer:**  
 PCB Piezotronics, Inc.  
 3425 Walden Avenue  
 Depew, New York 14043  
 USA

**Authorized European Representative:**  
 PCB Piezotronics Europe GmbH  
 Porschestrasse 20-30  
 41836 Hückelhoven  
 Germany

**Certifies that type of equipment:**      **Vibration Sensor(s)**

**Whose Product Models Include:**      **EX64..., EXTO64..., EXRV64... Series**

This declaration is applicable to all Vibration Sensor(s) of the above series which have the CE & (EX) ATEX mark on their data sheets and where those data sheets refer to this declaration of conformity. The data sheets for all model numbers referenced above, which include the CE & (EX) ATEX mark on such data sheets and refer to this Declaration of Conformity are hereby incorporated by reference into this Declaration.

**Conform to the following EU Directive(s) when installed per product documentation:**

2014/30/EU  
 2011/65/EU w/2015/863/EU  
 2014/34/EU

EMC Directive  
 RoHS Directive  
 ATEX Directive

### Harmonized Standards to which Conformity is Declared:

<b>Harmonized Standards</b>	EN 61326-1:2013  EN 61326-2-3: 2013  EN 61010-1:2010 EN 61010-1:2010/A1:2019/AC:2019-04 EN 61010-1:2010/A1:2019  EN 60079-0:2018  EN 60079-11: 2012  EN IEC 63000:2018	Electrical Equipment for Measurement, Control and Laboratory Use- EMC requirements - Part 1: General requirements  Electrical equipment for measurement, control and laboratory use - EMC requirements - Part 2-3: Particular requirements - Test configuration, operational conditions and performance criteria for transducers with integrated or remote signal conditioning  Safety Requirements for Electrical Equipment for Measurement, Control, and Laboratory Use - Part 1: General Requirements  General Explosive Atmosphere  Intrinsic safe, i  Technical documentation for the assessment of electrical and electronic products with respect to the restriction of hazardous substances (IEC 63000:2018)
<b>Emissions Test Standards</b>	EN 55011:2016, EN 55011:2016/A1:2017 EN 55011:2016/A11:2020	Industrial, scientific and medical (ISM) radio frequency equipment-Electromagnetic disturbance characteristics- Limits and methods of Measurement Class B
<b>Other Standards Applied (non-OJEU)</b>	EN 61000-4-2:2001  EN 61000-4-3:2006	Electromagnetic compatibility (EMC)–Part 4–2: Testing and measuring techniques– Electrostatic discharge immunity test  Electromagnetic compatibility (EMC) - Part 4-3: Testing and measurement techniques - Radiated, radio-frequency, electromagnetic field immunity test

<b>Immunity Test Standards</b>	EN 61000-4-4:2004  EN 61000-4-5:2005  EN 61000-4-6:2006  EN 61000-4-8:2001	Electromagnetic compatibility (EMC) - Part 4-4: Testing and measurement techniques - Electrical fast transient/burst immunity test  Electromagnetic compatibility (EMC) - Part 4-5: Testing and measurement techniques - Surge immunity test  Electromagnetic compatibility (EMC) - Part 4-6: Testing and measurement techniques - Immunity to conducted disturbances, induced by radio-frequency fields  Electromagnetic compatibility (EMC) – Part 4-8: Testing and measurement techniques – Power frequency magnetic field immunity test
<b>Test Reports</b>	EMC Reports Safety Reports	GM29045c GM29046s
<b>EC Type Examination</b>	ATEX Certification	LCIE 05 ATEX 6154 X Ex ia IIC T4, II 1G
<b>Voluntary Certification</b>	Supplemental ATEX Certification	LCIE 05 ATEX 6155 X Ex nL IIC T4 Ex nA IIC T4 (for EX64xB7y, EXTO64xB7y, and EXRV64xB7y)
<b>Notified Body Name</b>		Laboratoire Central des Industries Electriques (0081)
<b>Notified Body's Address</b>		<b>FONTENAY-AUX-ROSES (Head Office)</b> 33, avenue du Général Leclerc FR- 92260 Fontenay-aux-Roses Tel. : + 33 1 40 95 60 60 Fax : + 33 1 40 95 86 56

I, the undersigned, hereby declare that the equipment specified above conforms to the above Directive(s) Standard(s)

**Place:** Depew, NY **Date:** 03/26/2023

Signature:



Name: Wendy Willard

Title: Regulatory Affairs and Product Certification Specialist