



Model EX603C11

Intrinsically-safe industrial ceramic shear ICP® accel, 100 mV/g, 0.5 to 10k Hz, top exit, 10-ft integral cable, intrinsically safe, single point ISO 17025 accredited calibration

Installation and Operating Manual

**For assistance with the operation of this product,
contact the PCB Piezotronics, Inc.**

**Toll-free: 800-959-4464
24-hour SensorLine: 716-684-0001
Fax: 716-684-3823
E-mail: imi@pcb.com
Web: www.imi-sensors.com**



Repair and Maintenance

PCB guarantees Total Customer Satisfaction through its “Lifetime Warranty Plus” on all Platinum Stock Products sold by PCB and through its limited warranties on all other PCB Stock, Standard and Special products. Due to the sophisticated nature of our sensors and associated instrumentation, **field servicing and repair is not recommended and, if attempted, will void the factory warranty.**

Beyond routine calibration and battery replacements where applicable, our products require no user maintenance. Clean electrical connectors, housings, and mounting surfaces with solutions and techniques that will not harm the material of construction. Observe caution when using liquids near devices that are not hermetically sealed. Such devices should only be wiped with a dampened cloth—never saturated or submerged.

In the event that equipment becomes damaged or ceases to operate, our Application Engineers are here to support your troubleshooting efforts 24 hours a day, 7 days a week. Call or email with model and serial number as well as a brief description of the problem.

Calibration

Routine calibration of sensors and associated instrumentation is necessary to maintain measurement accuracy. We recommend calibrating on an annual basis, after exposure to any extreme environmental influence, or prior to any critical test.

PCB Piezotronics is an ISO-9001 certified company whose calibration services are accredited by A2LA to ISO/IEC 17025, with full traceability to SI through N.I.S.T. In addition to our standard calibration services, we also offer specialized tests, including: sensitivity at elevated or cryogenic temperatures, phase response, extended high or low frequency response, extended range, leak testing, hydrostatic pressure testing, and others. For more information, contact your local PCB Piezotronics distributor, sales representative, or factory customer service representative.

Returning Equipment

If factory repair is required, our representatives will provide you with a Return Material Authorization (RMA) number, which we use to reference any information you have already provided and expedite the repair process. This number should be clearly marked on the outside of all returned package(s) and on any packing list(s) accompanying the shipment.

Contact Information

PCB Piezotronics, Inc.
3425 Walden Ave.
Depew, NY14043 USA
Toll-free: (800) 828-8840
24-hour SensorLine: (716) 684-0001
General inquiries: info@pcb.com
Repair inquiries: rma@pcb.com

For a complete list of distributors, global offices and sales representatives, visit our website, www.pcb.com.

Safety Considerations

This product is intended for use by qualified personnel who recognize shock hazards and are familiar with the precautions required to avoid injury. While our equipment is designed with user safety in mind, the protection provided by the equipment may be impaired if equipment is used in a manner not specified by this manual.

Discontinue use and contact our 24-Hour Sensorline if:

- Assistance is needed to safely operate equipment
- Damage is visible or suspected
- Equipment fails or malfunctions

For complete equipment ratings, refer to the enclosed specification sheet for your product.

Definition of Terms and Symbols

The following symbols may be used in this manual:



DANGER

Indicates an immediate hazardous situation, which, if not avoided, may result in death or serious injury.

**CAUTION**

Refers to hazards that could damage the instrument.

**NOTE**

Indicates tips, recommendations and important information. The notes simplify processes and contain additional information on particular operating steps.

The following symbols may be found on the equipment described in this manual:



This symbol on the unit indicates that high voltage may be present. Use standard safety precautions to avoid personal contact with this voltage.



This symbol on the unit indicates that the user should refer to the operating instructions located in the manual.



This symbol indicates safety, earth ground.



PCB工业监视和测量设备 - 中国RoHS2公布表

PCB Industrial Monitoring and Measuring Equipment - China RoHS 2 Disclosure Table

部件名称	有害物质					
	铅 (Pb)	汞 (Hg)	镉 (Cd)	六价铬 (Cr(VI))	多溴联苯 (PBB)	多溴二苯醚 (PBDE)
住房	0	0	0	0	0	0
PCB板	X	0	0	0	0	0
电气连接器	0	0	0	0	0	0
压电晶体	X	0	0	0	0	0
环氧	0	0	0	0	0	0
铁氟龙	0	0	0	0	0	0
电子	0	0	0	0	0	0
厚膜基板	0	0	X	0	0	0
电线	0	0	0	0	0	0
电缆	X	0	0	0	0	0
塑料	0	0	0	0	0	0
焊接	X	0	0	0	0	0
铜合金/黄铜	X	0	0	0	0	0
本表格依据 SJ/T 11364 的规定编制。						
0：表示该有害物质在该部件所有均质材料中的含量均在 GB/T 26572 规定的限量要求以下。						
X：表示该有害物质至少在该部件的某一均质材料中的含量超出 GB/T 26572 规定的限量要求。						
铅是欧洲RoHS指令2011/65/ EU附件三和附件四目前由于允许的豁免。						

CHINA RoHS COMPLIANCE

Component Name	Hazardous Substances					
	Lead (Pb)	Mercury (Hg)	Cadmium (Cd)	Chromium VI Compounds (Cr(VI))	Polybrominated Biphenyls (PBB)	Polybrominated Diphenyl Ethers (PBDE)
Housing	O	O	O	O	O	O
PCB Board	X	O	O	O	O	O
Electrical Connectors	O	O	O	O	O	O
Piezoelectric Crystals	X	O	O	O	O	O
Epoxy	O	O	O	O	O	O
Teflon	O	O	O	O	O	O
Electronics	O	O	O	O	O	O
Thick Film Substrate	O	O	X	O	O	O
Wires	O	O	O	O	O	O
Cables	X	O	O	O	O	O
Plastic	O	O	O	O	O	O
Solder	X	O	O	O	O	O
Copper Alloy/Brass	X	O	O	O	O	O

This table is prepared in accordance with the provisions of SJ/T 11364.

O: Indicates that said hazardous substance contained in all of the homogeneous materials for this part is below the limit requirement of GB/T 26572.

X: Indicates that said hazardous substance contained in at least one of the homogeneous materials for this part is above the limit requirement of GB/T 26572.

Lead is present due to allowed exemption in Annex III or Annex IV of the European RoHS Directive 2011/65/EU.

INSTRUÇÕES PARA USO - EX(TO)(M)602yzzz/aaa, EX(TO)(M)603yzzz/aaa, EX(TO)(M)606yzzz/aaa, EX(TO)(M)607yzzz/aaa, e EX(TO)(M)608yzzz/aaa Series

Modelo(s)	EX(TO)(M)602yzzz/aaa, EX(TO)(M)603yzzz/aaa, EX(TO)(M)606yzzz/aaa, EX(TO)(M)607yzzz/aaa, e EX(TO)(M)608yzzz/aaa Series aonde: Opções do Modelo incluem: TO – Sensor de saída de temperatura M – Hardware e cabo de montagem métrica y = Uma letra de A a Z denotando nível de revisão (com “M” reservado para pedidos especiais do cliente) zzz = Dois ou Três Números 00 a 999 qual cabo / tipo de conector e sensibilidade, filtragem ou polarização (dois números) ou número sequencial de ordem especial (até três dígitos) aaa = Designa o comprimento do cabo e / ou o tipo de conector
Marcações	PCB Depew, NY IECEX LCIE 13.0045X LCIE 06 ATEX 6033X LCIE 06 ATEX 6032X DNV 18.0162 X Ex ia IIC T4 Ga Ta=121 °C Ex nA IIC T4 Gc Ta=121°C Instalar conforme desenho 67371
Colocação em serviço	Alimentação: Todos os sensores ICP® requerem excitação de corrente constante para operação adequada. Por esta razão, utilize apenas condicionadores de sinal de corrente constante PCB ou outras fontes aprovadas de corrente constante. A fonte de alimentação consiste em uma fonte de 18 a 30 Vcc regulada por corrente. Essa energia é regulada por um circuito limitador de corrente, que fornece a excitação de corrente constante necessária para a operação adequada dos sensores ICP®. Em geral, os dispositivos alimentados por bateria oferecem versatilidade para medições portáteis de baixo ruído, enquanto as unidades alimentadas por linha fornecem a capacidade de monitoramento contínuo. Consulte o catálogo de produtos da Divisão de Vibração para obter mais informações sobre condicionadores de sinal. NOTA: <i>Sob nenhuma circunstância a tensão deve ser fornecida a um acelerômetro ICP sem um diodo regulador de corrente ou circuito elétrico equivalente. Isso pode incluir ohmímetros, multímetros e testadores de continuidade.</i>
Uso Seguro	Depois de concluir a configuração do sistema, ligue o condicionador de sinal e aguarde de 1 a 2 minutos para que o sistema se estabilize. O medidor (ou LED) no condicionador de sinal deve estar lendo “verde”. Isso indica operação adequada e você pode começar a fazer medições. Se uma condição com defeito for indicada (leitura vermelha ou amarela), primeiro verifique todas as conexões do sistema, depois verifique a funcionalidade do cabo e do condicionador de sinal. Se o sistema ainda não funcionar corretamente, consulte um representante da fábrica da PCB. NOTA: <i>Sempre opere o acelerômetro dentro das limitações listadas na Folha de Especificações anexada. Operar o dispositivo fora desses parâmetros pode causar danos temporários ou permanentes ao sensor.</i>
Montagem	O EX(TO)(M)602yzzz/aaa, EX(TO)(M)603yzzz/aaa, EX(TO)(M)606yzzz/aaa, EX(TO)(M)607yzzz/aaa, e EX(TO)(M)608yzzz/aaa têm invólucros de titânio selados hermeticamente, com um cabo integral vedado e não requerem montagem. Apenas montagem na máquina que está sendo monitorada utilizando acessórios de montagem padrão.
Desmontagem	Além da remoção da montagem, não há desmontagem do sensor necessário para colocá-lo fora de serviço.
Manutenção	A manutenção de rotina, como a limpeza de conectores elétricos, invólucros e superfícies de montagem com soluções e técnicas que não prejudiquem o material físico da construção, é aceitável.

Manutenção	Devido à natureza sofisticada dos sensores e à instrumentação associada fornecida pela PCB Piezotronics, a manutenção ou reparo pelo usuário não é recomendada e, se tentada, pode anular a garantia de fábrica. No entanto, a calibração de rotina de sensores e instrumentação associada é recomendada, pois isso ajuda a aumentar a confiança na precisão da medição e nos dados adquiridos.
Reparo	No caso do equipamento ficar danificado ou deixar de funcionar, providências devem ser tomadas para devolver o equipamento à PCB Piezotronics para reparo. O serviço ou reparo do usuário não é recomendado e, se tentado, pode anular a garantia de fábrica.
Instalação	Visão geral: O sensor deve ser montado para ser colocado em serviço. Ao escolher um método de montagem, considere de perto as vantagens e desvantagens de cada técnica. Características como localização, robustez, amplitude, acessibilidade, temperatura e portabilidade são extremamente críticas. No entanto, a consideração mais importante e muitas vezes negligenciada é o efeito que a técnica de montagem tem no desempenho de alta frequência do acelerômetro. Os métodos de montagem incluem: Montagem do suporte, montagem adesiva, montagem magnética, suporte manual ou montagem da ponta da sonda. Cabeamento: O cuidado e a atenção na instalação do cabo e na condição do cabo são essenciais, pois a confiabilidade e a precisão de qualquer sistema de medição não são melhores do que a do seu elo mais fraco. Devido à natureza das medições de vibração, todos os cabos do sensor acabarão por fadigar e falhar. Uma boa prática de instalação prolongará a vida de um cabo, no entanto, é altamente recomendável manter os cabos de reserva à mão para permitir a continuação do teste no caso de uma falha no cabo.
Ajuste	O sensor é um dispositivo selado e nenhum ajuste do usuário é possível. No entanto, a calibração de rotina dos sensores pelo fabricante é recomendada, pois isso ajuda a aumentar a confiança na precisão da medição e nos dados adquiridos.
Áreas de perigo (para dispositivos de alívio de pressão)	N/A – não é um dispositivo de alívio de pressão.
Instruções de Treinamento	Sensores industriais devem ser instalados em áreas classificadas por profissionais treinados de acordo com os requisitos da norma ABNT NBR IEC 60079-14.
Detalhes sobre segurança da categoria de proteção	Ex ia é “segurança intrínseca”, que limita a energia das faíscas e temperaturas da superfície a níveis seguros. Ex nA é "Não Centelhante", o que garante que não há risco de formação de arco e faíscas ou superfícies quentes durante a operação normal
Parâmetros de Identidade e Limites (Valores)	Faixa de Temperatura: -54°C a +121°C Para Modelos com Conector de 2 pinos: $U_i = 28\text{ V}$, $I_i = 200\text{ mA}$, $P_i = 1\text{ W}$, $C_i = 16,2\text{ nF}$, $L_i = 0$ Para modelos com cabo integral (com um comprimento máximo de cabo de 305 m (1000 pés)): $U_i = 28\text{ V}$, $I_i = 200\text{ mA}$, $P_i = 1\text{ W}$, $C_i = 77,2\text{ nF}$, $L_i = 305\text{ }\mu\text{H}$ Para modelos com Amor cabo revestido (com um comprimento de cabo máxima de 305 m (1000 pés).): $U_i = 28\text{ V}$, $I_i = 200\text{ mA}$, $P_i = 1\text{ W}$, $C_i = 16,2\text{ nF}$, $L_i = 305\text{ }\mu\text{H}$
Condição Especial de Uso	Versão Ex ia: O equipamento só deve ser conectado a um equipamento certificado intrinsecamente seguro associado. Essa combinação deve ser compatível com as regras de segurança intrínsecas (consulte os parâmetros elétricos). O equipamento deve ser conectado de acordo com o desenho 64371 (página 1/2) Versão Ex nA: O equipamento deve ser conectado apenas a um equipamento cujos parâmetros elétricos sejam compatíveis com os parâmetros elétricos. O equipamento deve ser conectado de acordo com o desenho 64371 (página 2/2) ATENÇÃO – NÃO SEPARE QUANDO ENERGIZADO
Características Essencial de ferramentas para fixar ao sistemas (se qualquer)	N/A – Nenhuma ferramenta está instalada no sistema.
Desenhos e Diagramas	33701, 33700, 56178, 56179, 64371, 23402, 23575, 64374 e 41721.

Outros	LCIE 06 ATEX 6033 X, LCIE 06 ATEX 6032 X, IECEx LCIE 13.0045X e DNV 18.0162 X Para certificação ATEX “ia” – EN 60079-0 + A11:2013 e EN 60079-11:2012 Para certificação ATEX “nA” – EN 60079-0 + A11:2013 e EN 60079-15:2010 Para certificação IECEx “ia” – IEC 60079-0 Ed. 6 e IEC 60079-11 Ed. 6 Para certificação IECEx “nA” – IEC 60079-0 Ed. 6 e IEC 60079-15 Ed. 4 Para certificação INMETRO “ia” – ABNT NBR IEC 60079-0:2013 e ABNT NBR IEC 60079-11:2013 Para certificação INMETRO “nA” – ABNT NBR IEC 60079-0:2013 e ABNT NBR IEC 60079-15:2012
--------	---

Nota: A literatura (como o manual ou materiais de marketing) descrevendo o equipamento ou sistema de proteção não deve contradizer as instruções no que diz respeito aos aspectos de segurança.

Nota: IMI Sensors é uma divisão da PCB Piezotronics. Esta divisão está totalmente contida nas instalações de fabricação da PCB Piezotronics na Avenida Walden 3425, Depew, Nova York. Mesmo endereço, mesma instalação de fabricação. Parte da documentação contida no arquivo técnico associado a este aplicativo é rotulada IMI Sensors, A divisão da PCB Piezotronics e alguns são rotulados simplesmente como PCB Piezotronics. Os desenhos etiquetados PCB Piezotronics são desenhos de nível mais alto que são utilizados em várias divisões, enquanto os desenhos rotulados IMI são específicos dos modelos IMI. Haverá uma mistura de desenho IMI e PCB para suportar esta aplicação, e na realidade eles são a mesma entidade, porém com um nome comercial associado (IMI) que é reconhecido por nossa base de clientes.



INDUSTRIAL MONITORING INSTRUMENTATION DIVISION

Piezoelectric ICP® Accelerometers Operating Guide

Operating Guide with Enclosed Warranty Information

3424 Walden Avenue, Depew, New York 14043-2495

Phone (716) 684-0003

Fax (716) 684-3823

Toll Free Line 1-800-959-4IMI

**MANUAL NUMBER: 18405
MANUAL REVISION: A**

ECN NUMBER: 49766

**General
OPERATING GUIDE**

for use with

PIEZOELECTRIC ICP® ACCELEROMETERS

SPECIFICATION SHEET, INSTALLATION DRAWING AND CALIBRATION INFORMATION ENCLOSED

IMI ASSUMES NO RESPONSIBILITY FOR DAMAGE CAUSED TO THIS PRODUCT AS A RESULT OF PROCEDURES THAT ARE INCONSISTENT WITH THIS OPERATING GUIDE

1.0 INTRODUCTION

Congratulations on the purchase of a quality ICP® industrial sensor. In order to ensure the highest level of performance for this product, it is imperative that you properly familiarize yourself with the correct mounting and installation techniques before attempting to operate this device. If, after reading this manual, you have any additional questions concerning this sensor or its application, feel free to call an Application Engineer at **716-684-0003** or **800-959-4464**.

Proper sensor selection requires special attention to three main areas: sensor design, dynamic expectations, and application environment.

Sensor design encompasses the actual sensing element, the physical material, and component selection for the sensor. Preferred industrial accelerometers employ a shear sensing element with either a quartz or ceramic crystal.

Quartz sensing elements are typically used when long-term stability and minimum output shifts due to temperature changes are desired. Ceramic sensing elements provide excellent resolution and durability in noisy environments, and can be designed to supply low-frequency and high-frequency measurements. Shear-design sensors are preferred because of their inherent insensitivity to adverse environmental influences, such as case or base strain and thermal transients. Internal case isolation and shielding is important in avoiding erroneous signals resulting from ground loops and pick-up of electromagnetic and radio frequency interference. Other critical material selection criteria include non-magnetic stainless steel housing, hermetic sealing, and industrial military connectors. See Figure 1.

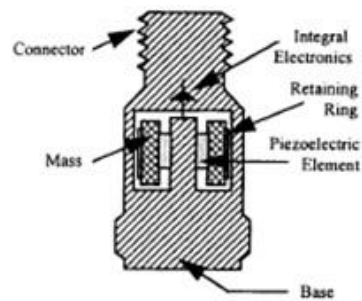

Figure 1. Typical Industrial Shear Mode Accelerometer

Dynamic expectations are application-specific and refer to the frequency range of measurement and the anticipated amplitudes of vibration. After careful review of the machinery to be monitored, minimum and maximum measurement frequency ranges may be established. The minimum measurement frequency is normally related to any sub-harmonics of running speed or any lower frequencies where vibration data is to be collected. The maximum measurement frequency of interest is determined by the maximum number of harmonics of an event like running speed, bearing frequencies, or gear mesh. This measurement frequency range should be well within the specified frequency range of the sensor.

Amplitude range refers to the anticipated levels of vibration to be measured. These values are related to the alarm levels set for the machine. By carefully evaluating the idiosyncrasies of the machinery, the predictive maintenance engineer can estimate the minimum expected vibration levels and ensure that the electrical noise floor of the accelerometer is less than those levels.

The environment of the application is a critical consideration during program implementation. The sensor chosen must be capable of surviving the wide range of conditions to which it is subjected; therefore, take time to evaluate potential conditions, such as high temperatures and chemical contaminants. The specified temperature range of the sensor must conform to the fluctuations of the environmental temperature. If harsh industrial chemicals are present, the sensor requires hermetic sealing and construction that resists corrosion. Finally, specific location of the sensor within the environment must be sensible, as both cable and sensor may be damaged by imprudent installation in heavily traveled, physically punishing areas.

2.0 ICP® ACCELEROMETERS

Enclosed in the back of this guide is a Specification Sheet, which lists the complete performance characteristics of the particular sensor.

All ICP® sensors require a constant current power source for proper operation. A typical sensing system includes an ICP® sensor, ordinary two conductor cable and a basic constant current power supply (as shown in Figure 2).

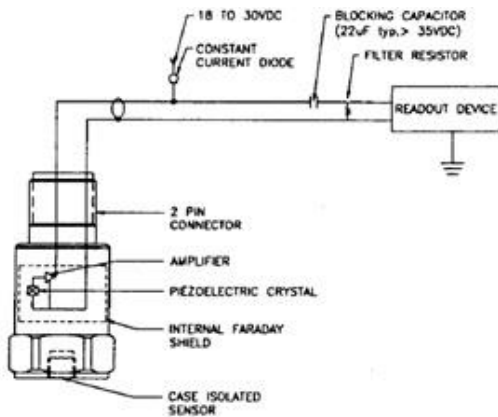

Figure 2. Typical Sensor System

The signal conditioner consists of a well-regulated 18 to 30 VDC source (battery or line-powered), a current-regulating diode (or equivalent constant current circuit), and a capacitor for decoupling (removing the bias voltage) the signal.

The current-regulating device is used in place of a resistor for several reasons. The very high dynamic resistance of the diode yields a source follower gain which is extremely close to unity and independent of

input voltage. Also, the diode can be changed to supply higher currents for driving long cable lengths. Constant current diodes, as shown in Figure 3, should be used in ICP® signal conditioners. **(The correct orientation of the diode within the circuit is critical for proper operation.)** Except for special models, standard ICP® sensors require a minimum of 2 mA for proper operation.

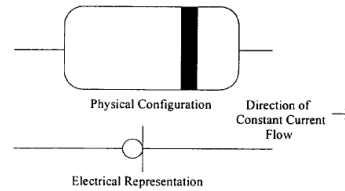

Figure 3. Constant Current Diode

The typical limits for this type of diode are to a 4 mA maximum rating; however, several diodes can be placed in parallel for higher current levels. All line-powered signal conditioners should use higher capacity (up to 20 mA) constant current circuits in place of the diodes, particularly when driving long signal cables (see Section 5).

Decoupling of the data signal occurs at the output stage of the signal conditioner. A 10 to 30 µF capacitor coupled with a resistor shifts the signal level to essentially eliminate the sensor bias voltage. The result is a drift-free AC mode of operation.

3.0 OPTIONAL FEATURES

In addition to standard features, a variety of options are also available. When listed before the model number, the following prefix letters indicate that the sensor is manufactured or supplied with optional features:

- CS - Canadian Standards Association Approved Sensor
- D - Dummy, non-working sensor for display purposes
- EX - Cenelec Approved Sensor
- FM - Factory Mutual Approval Sensor
- HT - High temperature accelerometer (325 °F)
- LB - Low Bias electronics
- LC - Limited Calibration (one point calibration)
- LP - Low Pass filter
- M - Metric mounting hardware and cable length
- U - Usable demonstration sensor (does not meet one or more minor specifications)
- VO - Velocity Output Sensors

MS – Mine Safety Approved Sensors
 TO – Temperature Output Sensor

Note: *Not all sensors are available with the optional prefixes. Contact the factory to discuss special features that may be needed.*

4.0 INSTALLATION OVERVIEW

When choosing a mounting method, consider closely both the advantages and disadvantages of each technique. Characteristics like location, ruggedness, amplitude range, accessibility, temperature, and portability are extremely critical. However, the most important and often overlooked consideration is the effect the mounting technique has on the high-frequency operating range of the accelerometer.

Shown in Figure 4 are six possible mounting techniques and their effects on the performance of a typical piezoelectric accelerometer. (**Note:** *Not all of the mounting methods may apply to your particular sensor.*) The mounting configurations and corresponding graph demonstrate how the high-frequency response of the accelerometer may be compromised as mass is added to the system and/or the mounting stiffness is reduced.

Note: *The low-frequency response is unaffected by the mounting technique. This roll-off behavior is typically fixed by the sensor's built-in electronics. However, when operating AC-coupled signal conditioners with readout devices having an input impedance of less than one megaohm, the low frequency range may be affected.*

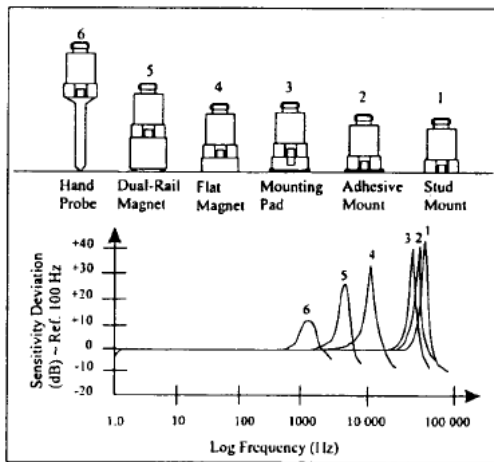
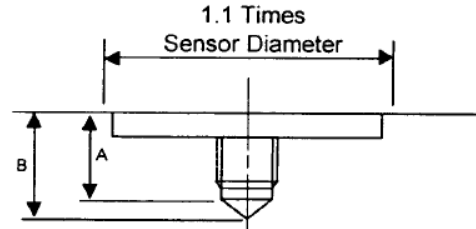

Figure 4. Assorted Mounting Configurations and Their Effects on High Frequency

4.1 STANDARD STUD MOUNT

This mounting technique requires smooth, flat contact surfaces for proper operation and is recommended for permanent and/or secure installations. Stud mounting is also recommended when testing at high frequencies.

Note: *Do NOT attempt mounting on curved, rough, or uneven surfaces, as the potential for misalignment and limited contact surface may significantly reduce the sensor's upper operating frequency range.*



	1/4-28 Stud	1/4-28 Captive Screw
A (in.)	.250	.250
B (in.)	.350	.350
Torque (ft-lb)	2 to 5	2 to 5

Figure 5. Mounting Surface Preparation

STEP 1: First, prepare a smooth, flat mounting surface and then drill and tap a mounting hole in the center of this area as shown in Figure 5.

A precision-machined mounting surface with a minimum finish of 63 μin (0.0016 mm) is recommended. (If it is not possible to properly prepare the machine surface, consider using an adhesive mounting pad as a possible alternative.) Inspect the area, checking that there are no burrs or other foreign particles interfering with the contact surface.

STEP 2: Wipe clean the mounting surface and spread on a light film of grease, oil, or similar coupling fluid prior to installation. See Figure 6.

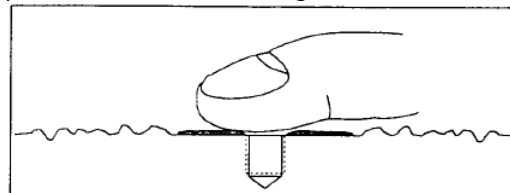

Figure 6. Mounting Surface Lubrication

Adding a coupling fluid improves vibration transmissibility by filling small voids in the mounting surface and increasing the mounting stiffness. For

semi-permanent mounting, substitute epoxy or another type of adhesive.

STEP 3: Hand-tighten the sensor/mounting stud to the machine, then secure the sensor with a torque wrench to the mounting surface by applying the recommended mounting torque. (See enclosed specification data sheet for proper mounting torque.)

It is important to use a torque wrench during this step. Under-torqueing the sensor may not adequately couple the device; over-torqueing may result in stud failure and possibly permanent damage.

4.2 ADHESIVE MOUNT

Adhesive mounting is often used for temporary installation or when the machine surface cannot be adequately prepared for stud mounting. Adhesives like hot glue or wax work well for temporary mounts; two-part epoxies and quick-bonding gels provide a more permanent mount.

Note: *Adhesively-mounted sensors often exhibit a reduction in high-frequency range. Generally, smooth surfaces and stiff adhesives provide the best frequency response. Contact the factory for recommended epoxies.*

METHOD 1 – Adhesive mounting base

This method involves attaching a base to the machine surface, then securing the sensor to the base. This allows for easy removal of the accelerometer.

STEP 1: Prepare a smooth, flat mounting surface. A minimum surface finish of 63 μin (0.0016 mm) generally works best.

STEP 2: Stud-mount the sensor to the appropriate adhesive mounting base according to the guidelines set forth in **STEPS 2** and **3** of the Stud Mount Procedure.

STEP 3: Place a small portion of adhesive on the underside of the mounting base. Firmly press down on the assembly to displace any extra adhesive remaining under the base. See Figure 7.

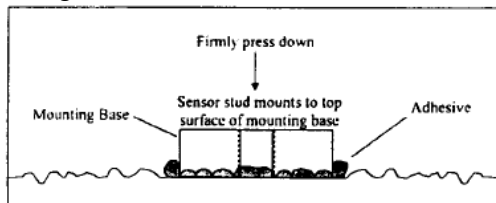

Figure 7. Mounting Base: Adhesive Installation

METHOD 2 – Direct Adhesive Mount

For restrictions of space or for convenience, most sensors (with the exception of integral stud models) can be adhesive-mounted directly to the machine surface.

STEP 1: Prepare a smooth, flat mounting surface. A minimum surface finish of 63 μin (0.0016 mm) generally works best.

STEP 2: Place a small portion of adhesive on the underside of the sensor. Firmly press down on the top of the assembly to displace any adhesive. Be aware that excessive amounts of adhesive can make sensor removal difficult. See Figure 8.

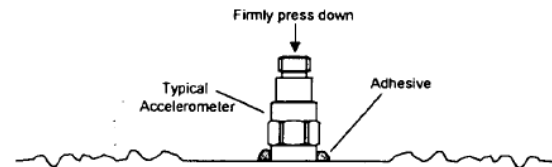

Figure 8. Direct Adhesive Mounting

4.3 MAGNETIC MOUNT

Magnetic mounting provides a convenient means for making portable measurements and is commonly used for machinery monitoring and other portable or trending applications.

Note: *The correct magnet choice and an adequately prepared mounting surface are critical for obtaining reliable measurements, especially at high frequencies. Poor installations can cause as much as a 50% drop in the sensor frequency range.*

Not every magnet is suitable for all applications. For example, rare earth magnets are commonly used because of their high strength. Flat magnets work well on smooth, flat surfaces, while dual-rail magnets are required for curved surfaces. In the case of non-magnetic or rough surfaces, it is recommended that the user first weld, epoxy, or otherwise adhere a steel mounting pad to the test surface. This provides a smooth and repeatable location for mounting.

STEP 1: After choosing the correct magnet type, inspect the unit, verifying that the mounting surfaces are flat and smooth. See Figure 9.

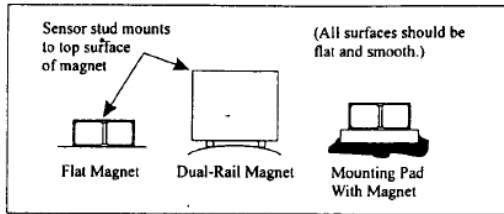

Figure 9. Magnet Types

STEP 2: Stud-mount the accelerometer to the appropriate magnet according to the guidelines set forth in **STEPS 2** and **3** of the Stud Mount Procedure.

STEP 3: Prepare a smooth, flat mounting surface. A minimum surface finish of 63 μin (0.0016 mm) generally works best. After cleaning the surface and checking for burrs, wipe on a light film of silicone grease, machine oil, or similar-type coupling fluid.

STEP 4: Mount the magnet/sensor assembly to the prepared test surface by gently “rocking” or “sliding” it into place. See Figure 10.

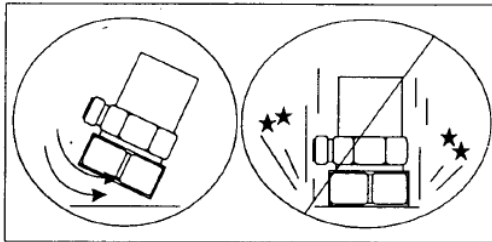

Figure 10. Magnet Mounting

Note: *Magnetically mounting accelerometers carelessly has the potential to generate very high (and very damaging) g levels. To prevent damage, install the assembly gently. If unsure, please contact the factory for assistance.*

4.4 HANDHELD OR PROBE TIP MOUNT

This method is NOT recommended for most applications. It is generally used where access to machinery may be a safety concern. Both the accuracy and repeatability at low (<5 Hz) and high frequency (>1 kHz) ranges are questionable.

5.0 CABLING

The selection of connectors and cables has a direct impact on the ruggedness and reliability of the sensor installation. A consideration when dealing with cables is the way in which the cable conductors are terminated.

ICP® accelerometers are internally amplified, two-wire accelerometers. Connections to the sensor require two leads: one for the power and signal, and the other for the common and signal return. Often, coaxial cables are used since only two conductors are needed. Coaxial cables are less expensive. With coaxial cables, however, erroneous signals can be introduced into sensor systems through ground loops, electromagnetic interference, or radio frequency interference (EMI or RFI). To avoid ground loops, there should only be one ground in the system.

It is recommended for permanent installations that the sensor be case-isolated and internally shielded with a dual-case design and use a two-conductor shielded cable to insure clean vibration signal transmission. Two-conductor shielded cables allow the signal and the signal return (common) to be fully shielded from the sensor to the readout equipment. To insure that ground loop signals are not induced, the shield should only be terminated at one end. Typically, the shield of a two-conductor shielded cable is left open or not connected at the sensor end and is tied to earth ground at the instrumentation end.

Operation over long cables may affect the frequency response of ICP® accelerometers, and introduce low frequency noise and high frequency distortion when an insufficient current is available to drive cable capacitance.

Unlike charge mode systems, where the system noise is a function of cable length, ICP® sensors provide a high voltage, low impedance output well-suited for driving long cables through harsh environments. While there is virtually no increase in noise with ICP® sensors, the capacitive loading of the longer cable may be distort or filter higher frequency signals depending on the supply current and the output impedance of the sensor.

Generally, this signal distortion is not a problem with lower frequency testing within a range up to 1,000 Hz. However, when monitoring higher frequency vibrations traveling over cables longer than 500ft, the possibility of signal distortion exists.

The maximum frequency that can be transmitted over a given cable length is a function of both the cable capacitance and the ratio of the peak signal voltage to the current available from the signal conditioner according to:



$$f_{\max} = \frac{10^9}{2\pi CV} \quad (\text{Equation 1})$$

[L_c-1]

Where, f_{\max} = maximum frequency (hertz)
C = cable capacitance (picofarads)
V = maximum peak output from sensor (volts)
 L_c = constant current from signal conditioner (mA)
 10^9 = scaling factor to equate units

Note that in this equation, 1 mA is subtracted from the total current supplied to sensor (L_c). This is done to compensate for powering the internal electronics. Also, note that these are typical values only.

When driving long cables, Equation 1 shows that, as the length of the cable, peak voltage output or maximum frequency of interest increases, a greater constant current will be required to drive the signal.

The nomograph on page 12 of this manual provides a simple, graphical method for obtaining the expected maximum frequency capability of an ICP® measurement system. The maximum peak signal voltage amplitude, cable capacitance and supplied constant current must be known or presumed.

For example, when running at 100 ft (30.5 m) cable with a capacitance of 30 pF/ft, the total capacitance is 3,000pF. This value can be found along the diagonal cable capacitance lines. Assuming the sensor operates at a maximum output range of 5 volts and the constant current available from the power supply is 2 mA, the ratio on the vertical axis can be calculated to equal 5. The intersection of the total cable capacitance and this ratio result in a maximum frequency of approximately 10.2 kHz.

The nomograph does not indicate whether the frequency amplitude response at a point is flat, rising or falling. For precautionary reasons, it is good general practice to increase the constant current (if possible) to the sensor (within its maximum limit) so that the frequency determined from the nomograph is approximately 1.5 to 2 times greater than the maximum frequency of interest.

Note: Higher current levels will deplete battery-powered signal conditioners at a faster rate. Also, any current not used by the cable goes directly to power the internal electronics and will create heat. This may cause the sensor to

exceed its maximum temperature specification. For this reason, do not supply excessive current over short cable runs or when testing at elevated temperatures.

5.1 CABLE CONNECTOR PROCEDURE

Care and attention to installation is essential, as the reliability and accuracy of your system is no better than that of the output cable.

STEP 1: Ascertain that you have ordered the correct cable type.

As with sensors, no cable can satisfy all applications. Special low-noise cabling should be used with high impedance, charge-output devices. ICP® sensors usually operate with any ordinary tow-wire cable. Industrial applications often require twisted/shielded cables to reduce the effects of EMI and RFI. PTFE-jacketed cabling may be necessary to withstand corrosive environments.

STEP 2: Connect the cable to the accelerometer. A small amount of thread-locking compound placed on the connector prior to attachment helps secure the cable during testing. In harsh environments, the connection can be sealed with silicone rubber, O-rings, and flexible heat-shrink tubing.

STEP 3: Plug the connector of the cable into the mating sensor connector. Then, holding the sensor stationary, secure the connector in place by tightening down the attached threaded cable sleeve.

STEP 4: Route the cable to the signal conditioner, making certain to stress-relieve the sensor/cable connection and minimize motion by clamping the cable at regular intervals.

Common sense should be used to avoid physical damage and minimize electrical noise. For instance, avoid routing cables near high-voltage wires. Do not route cables along floors or walkways where they be stepped on or become contaminated. Shielded cables should have the shield grounded at one end only, normally at the instrumentation end.

STEP 5: Finally, connect the remaining cable end to the signal conditioner or readout device. To dissipate charge that may have accumulated in the cable short the signal to ground prior to attachment.

6.0 POWERING

All ICP® sensors require constant current excitation for proper operation. For this reason only use approved constant-current sources. A typical system schematic is shown in Figure 11.

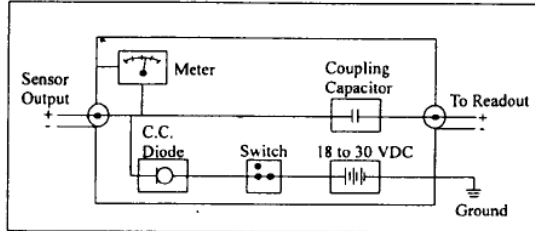

Figure 11. Typical System Schematic

The power supply consists of a regulated 18 to 30 VDC source. In general, battery-powered devices offer versatility for portable, low-noise measurements, whereas line-powered units provide the capability for continuous monitoring. This power is regulated by a current-limiting circuit, which provides the constant-current excitation required for proper operation of sensors with integral electronics.

Note: Under no circumstances should a voltage be supplied to an ICP® accelerometer without a current-regulating diode or equivalent electrical circuit.

A capacitor at the output stage of the device removes the sensor output bias voltage from the measurement signal. This provides a zero-based, AC-coupled output compatible with most standard readout devices.

Today, many FFT analyzers, data acquisition modules, and data collectors have constant-current excitation for direct use with ICP® sensors. However, before using this feature, check that the supply voltage and constant current are adequate for use with your sensor. Please contact the respective signal conditioner manufacturer or check the product manual for more information.

7.0 OPERATING

After completing the system setup, switch on the conditioner, the meter (or LED) and allow the sensor to power up. If a faulty condition is monitored, first check all system connections, then check the functionality of the cable and signal conditioner. If

the system still does not operate properly, consult an IMI Application Engineer.

Note: Always operate the accelerometer within the limitations listed on the Specification Sheet of your sensor. Operating the device outside of its parameters can cause temporary or permanent damage to the sensor.

8.0 ACCELEROMETER CALIBRATION

Note: It is good measurement practice to verify the performance of each accelerometer before and after each measurement.

Accelerometers are precision measuring instruments. They are highly engineered to provide accurate electrical signals representative of the vibration being monitored. Each sensor is calibrated by comparison to a known acceleration level. Some calibrations include frequency response curves, resonant frequency measurements, transvers sensitivity, and many other valuable tests. Applications requiring a high degree of accuracy or those in plants requiring certification and traceability require full calibration test results.

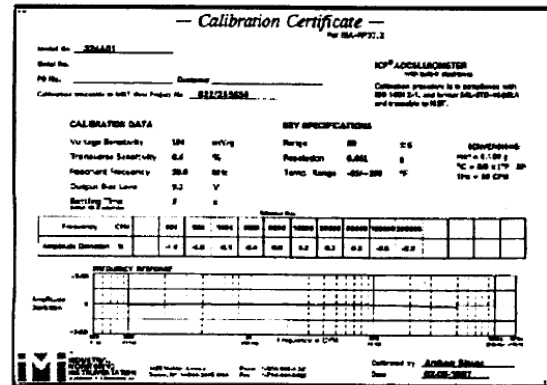

Figure 12. Typical Calibration Certificate

Some applications have much less stringent requirements for calibration certification. Simple sensitivity measurements at a single frequency may be sufficient; operational verification and certificates of conformance to published specifications may satisfy many plants' calibration needs. Reducing the final calibration requirements reduces the cost of manufacturing the sensor and should lower the price for predictive maintenance users.

Periodic recalibration may be required by plants with strict certification and traceability requirements. It is always recommended that the user has the sensor recalibrated periodically, particularly if the sensor has experienced a very high shock level or extreme temperatures for extended periods of time. Some plants develop in-house calibration capabilities for periodically verifying the performance of accelerometers. Products are available that provide a set 1 g-acceleration level at a fixed frequency for quick sensor checking.

For these reasons, it is recommended that a recalibration cycle be established for each accelerometer. This schedule is unique and is based on a variety of factors, such as extent of use, environmental conditions, accuracy requirements, trend information obtained from previous calibration records, contractual regulations, frequency of “cross-checking” against other equipment, manufacturer recommendation, and any risk associated with incorrect readings. International standards, such as ISO 10012-1, provide insight and suggested methods for determining recalibration intervals for most measuring equipment. With the above information in mind and under “normal” circumstances, a conservative suggestion of 12 to 24 month recalibration cycle for most piezoelectric accelerometers is advised.

8.1 SENSOR CALIBRATION

Accelerometer recalibration services are typically performed by IMI’s internal metrology laboratory. (Other international and private laboratories are also available.) The IMI laboratory is certified to ISO 9001, complies with ISO 10012-1 (and former MIL-STD-45662A), and uses equipment directly traceable to NIST. This assures an accurate calibration of relevant specifications.

The following includes a broad overview of the Back-to-Back Calibration technique normally used when calibrating accelerometers. This technique provides a quick and easy method for determining the sensitivity of a test accelerometer over a wide frequency range.

8.2 BACK-TO-BACK CALIBRATION THEORY

Back-to-back calibration is perhaps the most common method for determining the sensitivity of

piezoelectric accelerometers. This method relies on a simple comparison to a previously calibrated accelerometer, typically referred to as a reference standard, as shown in Figure 12.

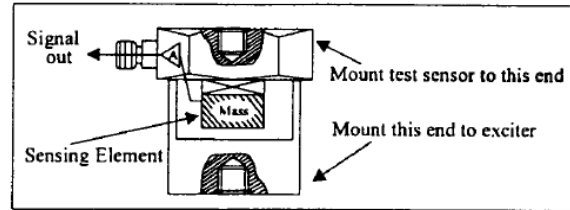

Figure 12. Reference Standard Accelerometer

These high-accuracy devices, which are directly traceable to a recognized standards laboratory, are designed for stability, as well as configured to accept a test accelerometer. By mounting a test accelerometer to the reference standard and then connecting this combination to a suitable vibration source, it is possible to vibrate both devices and compare the data as shown in Figure 13. (Test setups may be automated and vary, depending on the type and number for accelerometers being calibrated.)

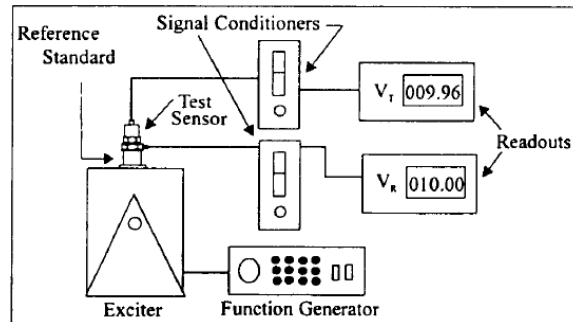

Figure 13. Typical Back-to-Back Calibration System

Because the acceleration is the same on both sensors, the ratio of their outputs (V_T/V_R) must also be the ratio of their sensitivities. With the sensitivity of the reference standard (S_R) known, the exact sensitivity of the test sensor (S_T) is easily calculated by using the following equation:

$$S_T = S_R \left(\frac{V_T}{V_R} \right)$$

By varying the frequency of the vibration, the sensor may be calibrated over its entire operating frequency range. The typical response of an unfiltered accelerometer is shown in Figure 14.

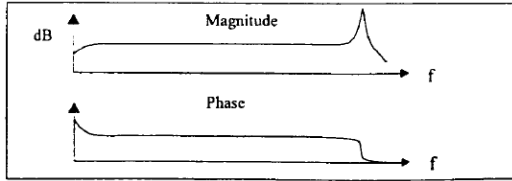

Figure 14. Typical Test Accelerometer Response

9.0 TROUBLESHOOTING

Piezoelectric sensors are dynamic measuring equipment. They use piezoelectric sensing elements to convert or transduce the mechanical phenomena to an electrical signal. The mechanical parameter may be force, pressure or vibration. The raw electrical signal from a piezoelectric charge element is a high impedance signal. This charge signal is normally converted to a low impedance voltage signal by either an external charge amplifier or an external voltage amplifier. The cables between the charge sensor and the amplifier must be high quality, low noise cable and must be kept as short as possible. Figure 15 shows a typical high impedance system.

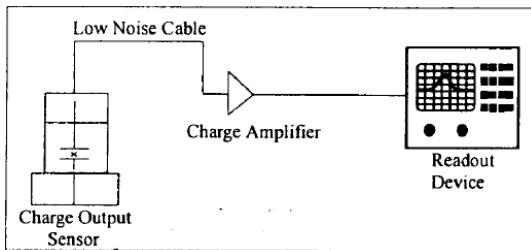

Figure 15. High Impedance System Connection

Internally amplified sensors employ miniature amplifiers to convert the high impedance charge signal into a low impedance voltage signal. These amplifiers are internal to the sensor, and therefore, do not require low noise cables or external amplifiers. These amplifiers have set gain so that output sensitivities are standardized.

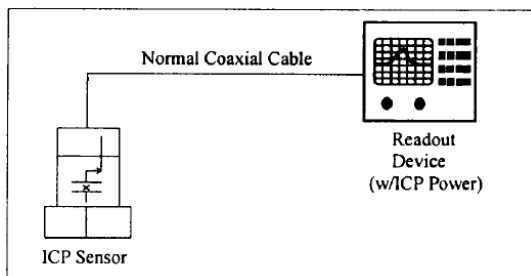

Figure 16. Sensor with Integral Electronics System Connector

ICP® sensors are two-wire sensors. They are powered with a constant current DC source. The power supply is typically 18 to 30 volts DC current limited via a constant current between 2 and 20 mA. Typical battery operated supplies offer 2mA of constant current to extend battery life while continuous monitoring systems offer more current in order to drive longer cables. Figure 16 shows a typical system for a sensor with integral electronics.

The signal output of a sensor with integral electronics is a low impedance voltage signal proportional to the dynamic measurement such as force, pressure, or vibration. This voltage signal is carried on a DC bias voltage. The AC dynamic signal is superimposed on the DC bias voltage and is allowed to swing between the supply voltage and ground as shown in Figure 17. Unlike an operational amplifier that requires a plus and minus supply and allows the signal to “ride” on ground and “swing” between the plus and minus “rails,” the sensor with integral electronics requires the output signal to be DC biased.

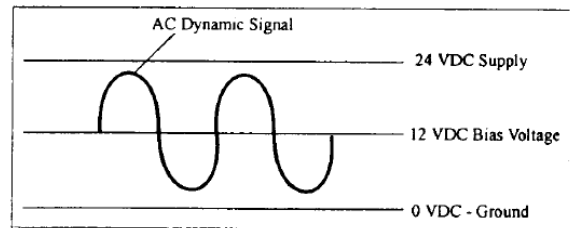

Figure 17. Sensor DC Bias Voltage

This DC bias voltage is an excellent diagnostic tool. The voltage provides a means of verifying that the amplifier is “turned on.” Typical input/output power supplies will block this DC bias voltage at the output via a blocking capacitor in order to AC couple the signal to readout devices. By “teeing” off the input into a DC volt meter, as shown in Figure 18, the bias voltage can be measured.

While measuring the supply voltage, the bias voltage can be measured after the sensor is plugged in. If the meter stays at supply, something in the system is open or not connected. If the meter reads “0,” something in the system is shorted. If the meter reads within the bias voltage range of the sensor, then the sensor and cabling are functioning properly.

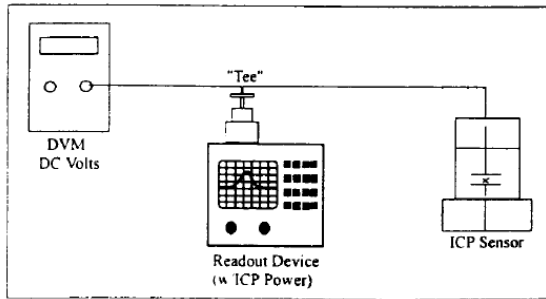

Figure 18. DC Bias Voltage Measurement

10.0 REPAIR/RETURN PROCEDURE

Because of the nature of most IMI instrumentation, field repair is typically NOT recommended and may void any warranty. If factory service is required, contact IMI for a **RETURN MATERIAL AUTHORIZATION (RMA)** number prior to sending equipment to the factory. Please have information available, such as model and serial number. Also, to insure efficient service, be sure to include a written description of the symptoms and problems with the equipment to a local sales representative or distributor, or contact IMI if none are located in your area.

Customers outside the U.S. should consult their local IMI distributor for information on returning equipment. For exceptions, please contact the International Sales department at IMI to request shipping instructions and an

RMA. For assistance, please call **(716) 684-0003**, or fax us at **(716) 684-3823**. You may also receive assistance via e-mail at imi@pcb.com or visit our website at www.pcb.com.

11.0 CUSTOMER SERVICE/WARRANTY

IMI, a division of PCB Piezotronics, guarantees **Total Customer Satisfaction**. If, at any time, for any reason, you are not completely satisfied with any IMI product, IMI will repair, replace or exchange it at no charge. You may also choose to have your purchase price refunded.

IMI instrumentation is warranted against defective material workmanship for 1 year unless otherwise expressly specified. Damage to instruments caused by incorrect power or misapplication, is not covered by warranty. *If there are any questions regarding power, intended application, or general usage, please consult with your local sales contact or distributor.* Batteries or expendable hardware items are not covered by warranty.

IMI offers to all customers, at no charge, 24-hour phone support. This service makes product or application support available to our customers, day or night, seven days a week. When unforeseen problems or emergency situations arise, call the **IMI Hot Line at (716) 684-0003**, and an application specialist will assist you.

Cable Driving Nomograph

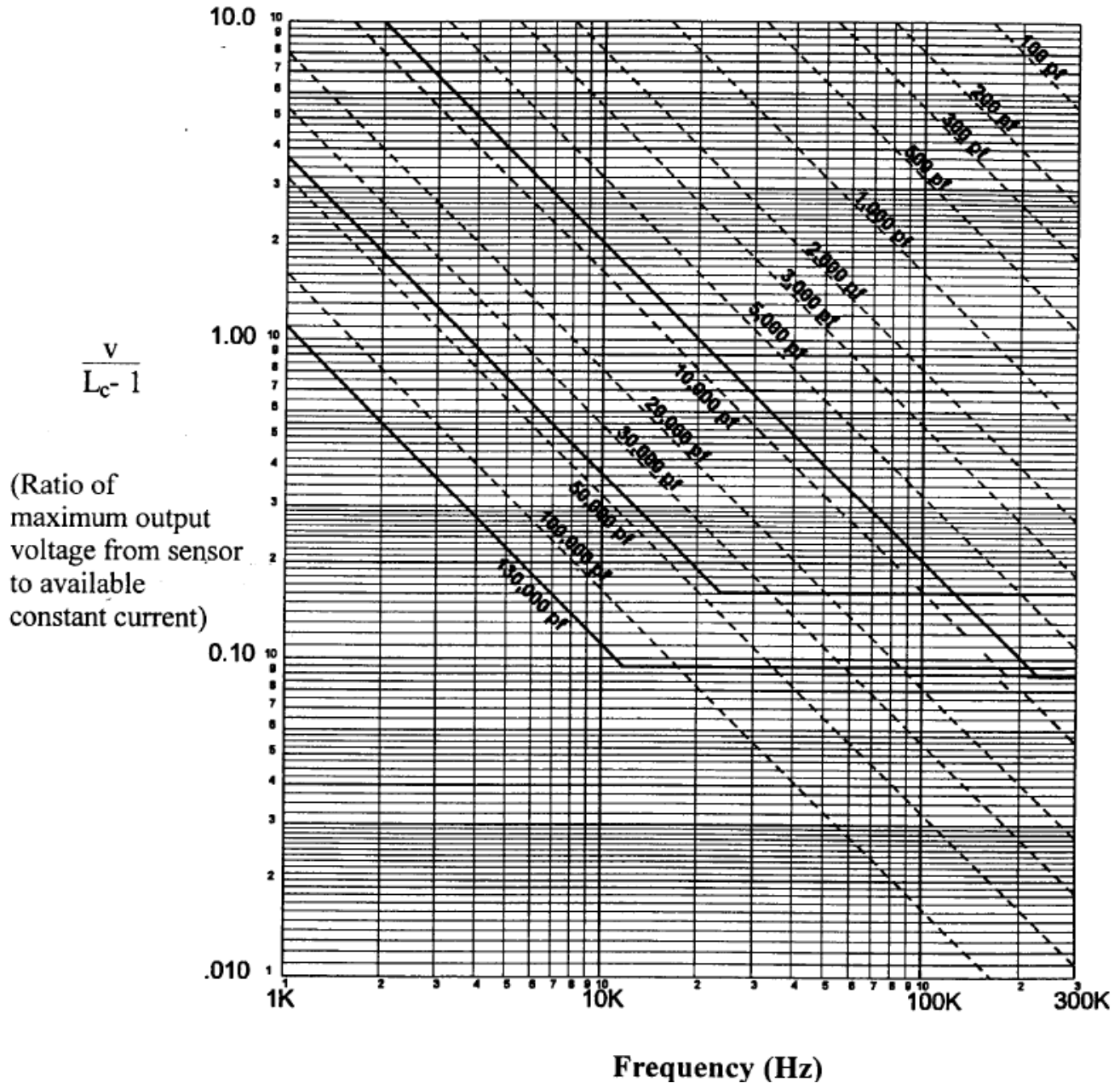

	ENGLISH	SI	
Performance			
Sensitivity(± 10 %)	100 mV/g	10.2 mV/(m/s ²)	[2]
Measurement Range	± 50 g	± 490 m/s ²	
Frequency Range(± 3 dB)	30 to 600,000 cpm	0.5 to 10,000 Hz	[3]
Resonant Frequency	1500 kcpm	25 kHz	[1]
Broadband Resolution(1 to 10,000 Hz)	350 µg	3434 µm/s ²	[1]
Non-Linearity	± 1 %	± 1 %	[4]
Transverse Sensitivity	≤ 7 %	≤ 7 %	
Environmental			
Overload Limit(Shock)	5000 g pk	49,050 m/s ² pk	
Temperature Range	-65 to +250 °F	-54 to +121 °C	
Temperature Response	See Graph	See Graph	[1]
Enclosure Rating	IP68	IP68	
Electrical			
Settling Time(within 1% of bias)	≤ 2.0 sec	≤ 2.0 sec	
Discharge Time Constant	≥ 0.3 sec	≥ 0.3 sec	
Excitation Voltage	18 to 28 VDC	18 to 28 VDC	
Constant Current Excitation	2 to 20 mA	2 to 20 mA	
Output Impedance	<150 ohm	<150 ohm	
Output Bias Voltage	8 to 12 VDC	8 to 12 VDC	
Spectral Noise(10 Hz)	8 µg/√Hz	78.5 (µm/s ²)/√Hz	[1]
Spectral Noise(100 Hz)	5 µg/√Hz	49.1 (µm/s ²)/√Hz	[1]
Spectral Noise(1 kHz)	4 µg/√Hz	39.2 (µm/s ²)/√Hz	[1]
Electrical Isolation(Case)	>10 ⁸ ohm	>10 ⁸ ohm	
Physical			
Size (Hex x Height)	11/16 in x 4.7 in	18 mm x 119 mm	
Weight(without cable)	1.8 oz	51 gm	
Mounting Thread	1/4-28 Female	1/4-28 Female	[5]
Mounting Torque	2 to 5 ft-lb	2.7 to 6.8 N-m	
Sensing Element	Ceramic	Ceramic	
Sensing Geometry	Shear	Shear	
Housing Material	Stainless Steel	Stainless Steel	
Sealing	Welded Hermetic	Welded Hermetic	
Electrical Connector	Molded Integral Cable	Molded Integral Cable	
Electrical Connection Position	Top	Top	
Cable Length	10 ft	3.0 m	
Cable Type	Polyurethane	Polyurethane	[6]

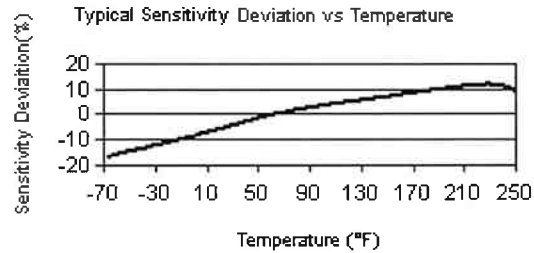

All specifications are at room temperature unless otherwise specified.
 In the interest of constant product improvement, we reserve the right to change specifications without notice.
 ICP® is a registered trademark of PCB Group, Inc.

OPTIONAL VERSIONS		
Optional versions have identical specifications and accessories as listed for the standard model except where noted below. More than one option may be used.		
EX - ATEX or ATEX and CSA Hazardous Area Approval		
Hazardous Area Approval	EEx nL IIC T4, -40°C≤Tas 121°C, II 3 G	EEx nL IIC T4, -40°C≤Tas 121°C, II 3 G
Hazardous Area Approval	EEx ia IIC T4, -40°C≤Tas≤121° C, II 1 G	EEx ia IIC T4, -40°C≤Tas≤121° C, II 1 G
Hazardous Area Approval	CI I, Div I, Groups A, B, C, D; CI II, Div I, Groups E, F, G; CI III, Div I	CI I, Div I, Groups A, B, C, D; CI II, Div I, Groups E, F, G; CI III, Div I
Hazardous Area Approval	Exia IIC T4, AExia IIC, T4	Exia IIC T4, AExia IIC, T4
Hazardous Area Approval	CI I, Div 2, Groups A, B, C, D; ExnL IIC T4, AExnA IIC T4	CI I, Div 2, Groups A, B, C, D; ExnL IIC T4, AExnA IIC T4
M - Metric Mount		
Supplied Accessory : Model M081A61 Mounting Stud 1/4-28 to M6 X 1 (1) replaces Model 081A40		
TO - Temperature Output		
Temperature Output Range	36 to 250 °F	2 to 121 °C
Temperature Scale Factor	5.56 mV/°F + 32	+10 mV/°C
Electrical Connections(Red)	Acceleration Output	Acceleration Output
Electrical Connections(Black)	Ground	Ground
Electrical Connections(White)	Temperature Output	Temperature Output
Electrical Connections(Green)	Ground	Ground

NOTES:
 [1] Typical.
 [2] Conversion Factor 1g = 9.81 m/s².
 [3] The high frequency tolerance is accurate within ±10% of the specified frequency.
 [4] Zero-based, least-squares, straight line method.
 [5] 1/4-28 has no equivalent in S.I. units.
 [6] Twisted shielded pair.
 [7] See PCB Declaration of Conformance PS023 or PS060 for details.

SUPPLIED ACCESSORIES:
 Model 081A40 Mounting Stud
 Model ICS-2 NIST-traceable single-axis single-point amplitude response calibration at 6000 cpm (100 Hz) (1)

Entered: <i>JH</i>	Engineer: <i>JL</i>	Sales: <i>BJ</i>	Approved: <i>UF</i>	Spec Number:
Date: <i>3/20/07</i>	Date: <i>3/21/07</i>	Date: <i>3/21/07</i>	Date: <i>3/21/07</i>	15776

 IMI SENSORS A PCB PIEZOTRONICS DIV. 3425 Walden Avenue, Depew, NY 14043	Phone: 800-959-4464 Fax: 716-684-3823 E-Mail: imi@pcb.com
--	---

INSTRUCTIONS FOR USE - EX(TO)(M)602yzzz/aaa, EX(TO)(M)603yzzz/aaa, EX(TO)(M)606yzzz/aaa, EX(TO)(M)607yzzz/aaa, and EX(TO)(M)608yzzz/aaa Series

<p>Model(s)</p>	<p>EX(TO)(M)602yzzz/aaa, EX(TO)(M)603yzzz/aaa, EX(TO)(M)606yzzz/aaa, EX(TO)(M)607yzzz/aaa, and EX(TO)(M)608yzzz/aaa Series where: Model Options Include: TO – Temperature Output Sensor M – Metric mounting hardware and cable y = One Letter from A to Z denoting revision level (with “M” reserved for customer Special Orders) zzz = Two or Three Numbers 00 to 999 which cable/connector type and sensitivity, filtering, or bias (two numbers) or special order sequential number (up to three digits) aaa = Designates cable length and/or connector type</p>
<p>Markings</p>	<p>PCB Depew, NY IECEX LCIE 13.0045X LCIE 06, ATEX 6033X LCIE 06, ATEX 6032X Ex ia IIC T4 Ga Ta=121°C Ex nA IIC T4 Gc Ta=121°C Install per 64371</p>
<p>Putting Into Service</p>	<p>Powering: All ICP® sensors require constant current excitation for proper operation. For this reason, use only PCB constant-current signal conditioners or other approved constant-current sources. The power supply consists of a current-regulated, 18 to 30 VDC source. This power is regulated by a current-limiting circuit, which provides the constant-current excitation required for proper operation of ICP® sensors. In general, battery-powered devices offer versatility for portable, low-noise measurements, whereas line-powered units provide the capability for continuous monitoring. Consult the Vibration Division’s product catalog for more information about signal conditioners. NOTE: <i>Under no circumstances should a voltage be supplied to an ICP® accelerometer without a current-regulating diode or equivalent electrical circuit. This may include ohmmeters, multi-meters and continuity testers.</i></p>
<p>Safe Use</p>	<p>After completing the system setup, switch on the signal conditioner and allow 1 to 2 minutes for the system to stabilize. The meter (or LED) on the signal conditioner should be reading “green.” This indicates proper operation and you may begin taking measurements. If a faulty condition is indicated (red or yellow reading), first check all system connections, then check the functionality of the cable and signal conditioner. If the system still does not operate properly, consult a PCB factory representative. NOTE: <i>Always operate the accelerometer within the limitations listed on the enclosed Specification Sheet. Operating the device outside these parameters can cause temporary or permanent damage to the sensor.</i> WARNING: <i>Do not separate when Energized.</i></p>
<p>Assembling</p>	<p>The EX(TO)(M)602yzzz/aaa, EX(TO)(M)603yzzz/aaa, EX(TO)(M)606yzzz/aaa, EX(TO)(M)607yzzz/aaa, and EX(TO)(M)608yzzz/aaa Series have hermetically sealed titanium housings, with a sealed integral cable, and do not require any assembly. Only mounting to the machine being monitored using standard mounting accessories.</p>
<p>Dismantling</p>	<p>Other than removal from the mounting, there is no disassembly of the sensor required to take it out of service.</p>

Maintenance	Routine maintenance, such as the cleaning of electrical connectors, housings, and mounting surfaces with solutions and techniques that will not harm the physical material of construction, is acceptable.
Servicing	Due to the sophisticated nature of the sensors and associated instrumentation provided by PCB Piezotronics, user servicing or repair is not recommended and, if attempted, may void the factory warranty. However, routine calibration of sensors and associated instrumentation is recommended as this helps build confidence in measurement accuracy and acquired data.
Repair	In the event that equipment becomes damaged or ceases to operate, arrangements should be made to return the equipment to PCB Piezotronics for repair. User servicing or repair is not recommended and, if attempted, may void the factory warranty.
Installation	<p>Overview: Sensor must be mounted in order to be put into service. When choosing a mounting method, consider closely both the advantages and disadvantages of each technique. Characteristics like location, ruggedness, amplitude range, accessibility, temperature, and portability are extremely critical. However, the most important and often overlooked consideration is the effect the mounting technique has on the high-frequency performance of the accelerometer. Mounting methods include: Stud mount, adhesive mount, magnetic mount, handheld, or probe tip mount.</p> <p>Cabling: Care and attention to cable installation and cable condition is essential as the reliability and accuracy of any measurement system is no better than that of its weakest link. Due to the nature of vibration measurements, all sensor cables will ultimately fatigue and fail. Good installation practice will extend the life of a cable, however, it is highly recommended to keep spare cables on hand to enable continuation of the test in the event of a cable failure.</p>
Adjustment	The sensor is a sealed device and no user adjustments are possible. However, routine calibration of sensors by the manufacturer is recommended as this helps build confidence in measurement accuracy and acquired data.
Danger Areas (for pressure-relief devices)	N/A – not a pressure relief device.
Training Instructions	Industrial sensors must be installed in Hazardous Locations by trained professionals according to EN/IEC 60079-14 requirements.
Details on Safety of Protection Category	Ex ia is “intrinsic safety”, which limits the energy of sparks and surface temperatures to safe levels. Ex nA is “Non-Sparking”, which ensures that there is no risk of arcing and sparking or hot surfaces during normal operation.
Entity Parameters and Limits (Values)	<p>Temperature Range: -54°C to +121°C Connector Version: Ui = 28V, Ii = 120 mA, Pi = 0.84W, Ci = 46.5nF, Li= 0</p> <p>Integral Cable Version (with a max cable length of 152.5 m (500 ft.)) Ui = 28V, Ii = 120 mA, Pi = 0.84W, Ci = 77nF, Li= 152.5 μH</p>
Special Conditions of Use	<p>Version Ex ia :</p> <p>The apparatus must only be connected to a certified associated intrinsically safe equipment. This combination must be compatible regarding intrinsic safety rules (see electrical parameters). The apparatus shall be connected according to drawing 64371 (page 1/2).</p> <p>Version Ex nA:</p> <p>The apparatus must be only connect to an equipment whose electrical parameters are compatible with the electrical parameters. The apparatus shall be connected according to drawing 64371 (page 2/2).</p> <p>WARNING: Do not separate when Energized.</p>
Essential Characteristics of tools fitted to the system (if any).	N/A – No tools are fitted to the system.

Drawings and Diagrams	33701, 33700, 56178, 56179, 64371, 23402, 23575, 64374, and 41721.
Other	EN 60079-0:2012+A11:2013 EN 60079-11:2012 EN 60079-15:2010 IEC 60079-0 Ed. 6 IEC 60079-11 Ed. 6 IEC 60079-15 Ed. 4

Note: Literature (such as the manual or marketing materials) describing the equipment or protective system must not contradict the instructions with regard to safety aspects.

Note: IMI sensors is a Division of PCB Piezotronics. This Division is wholly contained in the PCB Piezotronics manufacturing facility at 3425 Walden Avenue, Depew, New York. Same address, same manufacturing facility. Some of the documentation contained in the Technical File associated with this application is labeled IMI Sensors, A PCB Piezotronics Div. and some is labeled simply PCB Piezotronics. PCB Piezotronics labeled drawing are higher level drawings which are used across multiple divisions, while IMI labeled drawing are specific to IMI models. There will be a mixture of IMI and PCB drawing to support this application, and in reality they are the same entity however with an associated trade name (IMI) that is recognized by our customer base.

PCB Piezotronics Inc. claims proprietary rights in the information disclosed herein. Neither it nor any reproduction thereof will be disclosed to others without the written consent of PCB Piezotronics Inc.

1 REVISIONS		
REV	DESCRIPTION	DIN
A	UPDATED TITLE BLOCK	52852

16959

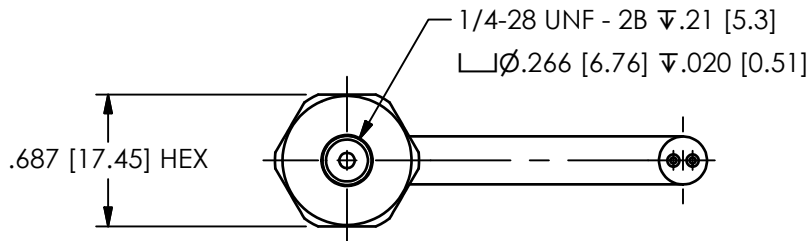
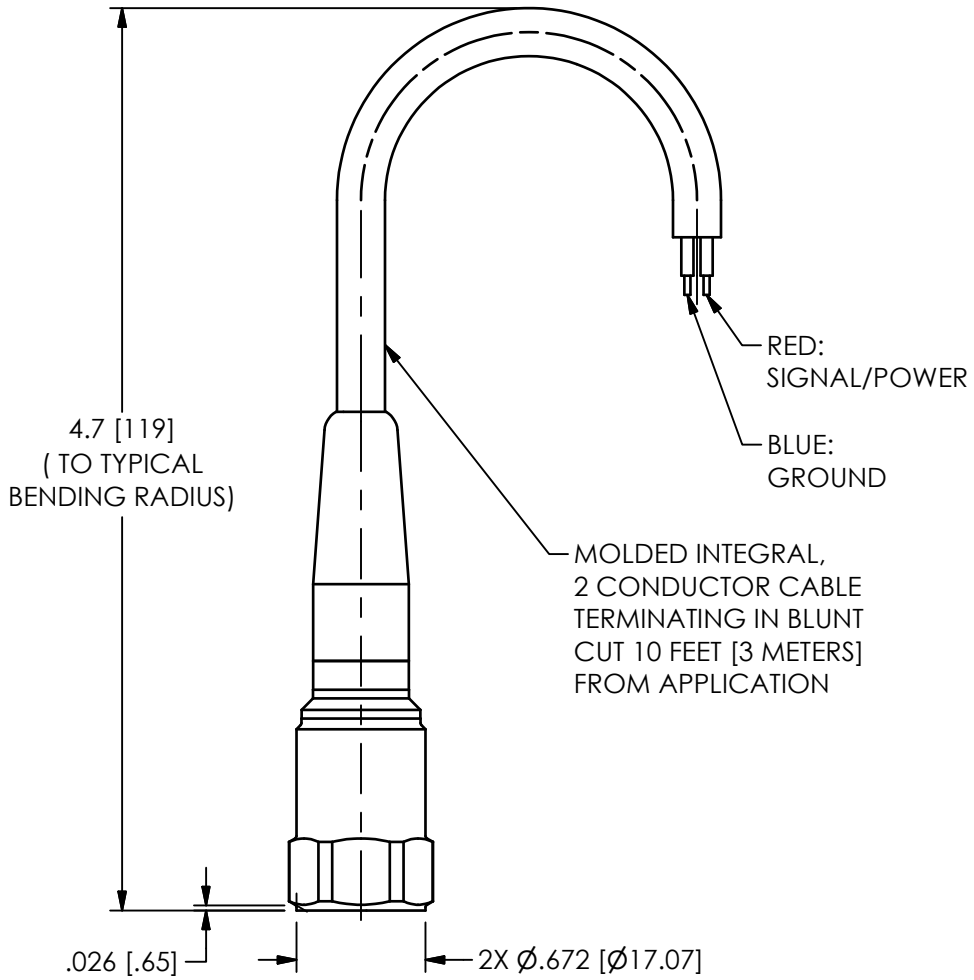

UNLESS OTHERWISE SPECIFIED TOLERANCES ARE:	
DIMENSIONS IN INCHES	DIMENSIONS IN MILLIMETERS [IN BRACKETS]
DECIMALS XX ±.03 XXX ±.010	DECIMALS X ± 0.8 XX ± 0.25
ANGLES ± 2 DEGREES	ANGLES ± 2 DEGREES
CABLE TOLERANCES IN ENGLISH	CABLE TOLERANCES IN METRIC
1" ≤ LENGTH < 1' = +1" / - 0	2.54cm ≤ LENGTH < 30.5cm = +2.54cm / - 0
1' ≤ LENGTH < 5' = +2" / - 0	30.5cm ≤ LENGTH < 1.5m = +5.1cm / - 0
5' ≤ LENGTH < 100' = +6" / - 0	1.5m ≤ LENGTH < 30.5m = +15.2cm / - 0
100' ≤ LENGTH = +1' / - 0	30.5m ≤ LENGTH = +30.5cm / - 0
FILLETS AND RADII .003 - .005	FILLETS AND RADII 0.07 - 0.13

DRAWN		CHECKED		ENGINEER	
JJF	5/17/22	JJF	5/17/22	GGG	5/17/22
TITLE					
OUTLINE DRAWING INTEGRAL CABLE 603C1X, M SERIES					

PCB PIEZOTRONICS
AN AMPHENOL COMPANY

3425 WALDEN AVE. DEPEW, NY 14043
(716) 684-0001 E-MAIL: sales@pcb.com

CODE IDENT. NO. 52681	DWG. NO. 16959
SCALE: FULL	SHEET 1 OF 1

PCB Piezotronics Inc. claims proprietary rights in the information disclosed hereon. Neither it nor any reproduction thereof will be disclosed to others without the written consent of PCB Piezotronics Inc.

64371

SCHEDULE DRAWING

NO MODIFICATIONS PERMITTED WITHOUT REFERENCE TO THE NOTIFIED BODY

REVISIONS		
REV	DESCRIPTION	DIN
A	UPDATED NOTES, REMOVED LCIE	49938

NON-HAZARDOUS / SAFE AREA HAZARDOUS AREA ZONE 0

CABLE

TRANSDUCER

VIN ≤ +24 VOLTS

SINGLE CHANNEL

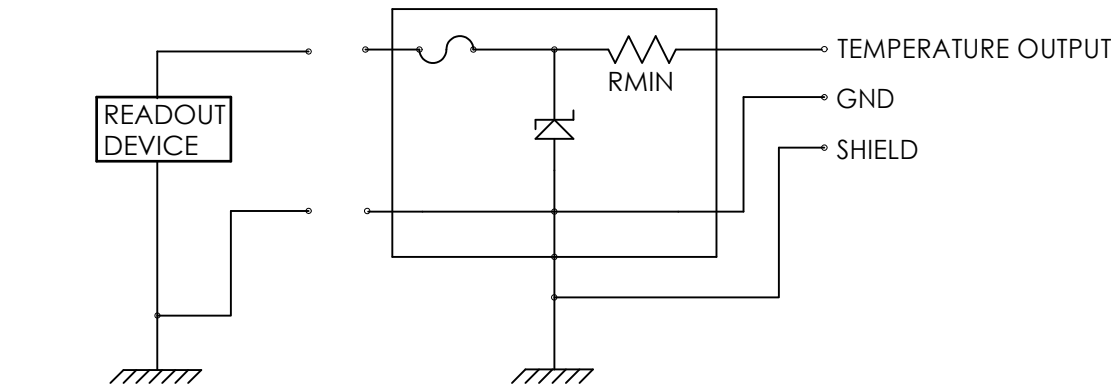
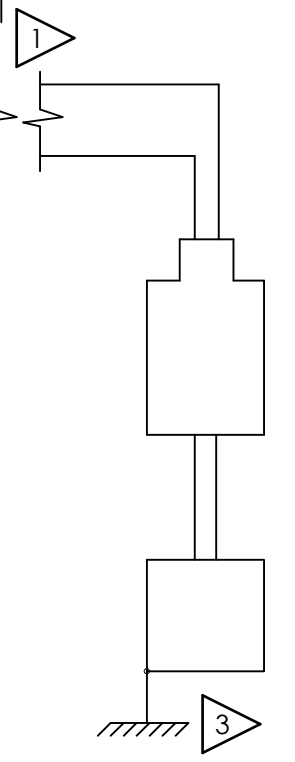
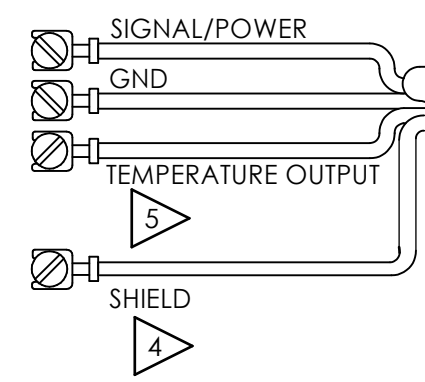
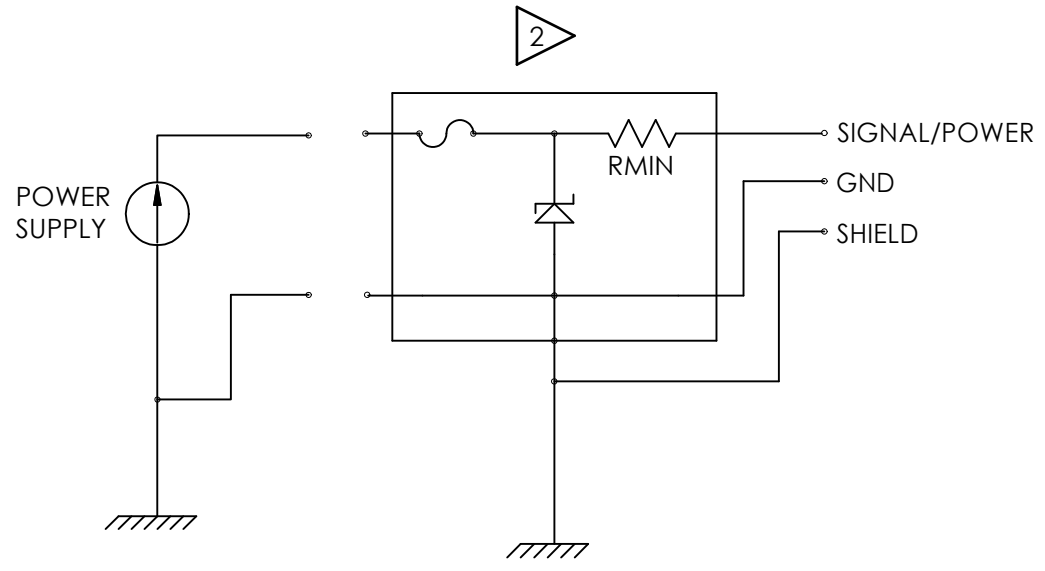

- 5 ONLY APPLICABLE FOR "TO" OPTION
- 4 SHIELDS TO BE EARTHED AT BARRIER ENDS
- 3 THE INSTALLER SHALL INSURE THAT THE TRANSDUCER MOUNTING STRUCTURE IS AT THE SAME GROUNDING POTENTIAL AS THE BARRIER GROUND. TOTAL EARTH LOOP IMPEDANCE SHALL BE LESS THAN 1 OHM
- 2 BARRIER WILL BE MOUNTED IN AN ENCLOSURE THE SUITABILITY OF WHICH WILL BE DETERMINED BY LOCAL AUTHORITIES.

1 ENTITY APPLICATION

BARRIER	I.S. APPARATUS
$V_{oc}/U_o \leq$	V_{MAX} / UI
$I_{sc}/I_o \leq$	I_{MAX} / II
$C_a/C_o >$	$C_I + C_{CABLE}$
$L_a/L_o >$	$L_I + L_{CABLE}$
$P_o \leq$	P_I (CENELEC ONLY)

BARRIERS WITHIN THE SPECIFIED LIMITATIONS ARE PERMITTED

ENTITY PARAMETERS

CONNECTOR VERSION	INTEGRAL CABLE VERSION
$U_i = 28V$	$U_i = 28V$
$I_i = 120 mA$	$I_i = 120 mA$
$P_i = 0.84 W$	$P_i = 0.84 W$
$C_i = 46.5 nF$	$C_i = 77 nF$
$L_i = 0 uH$	$L_i = 152.5 uH$

CERTIFIED BY THE APPROPRIATE APPROVAL AUTHORITY FOR CONNECTION TO THE FOLLOWING AREAS:

ZONE 0
Ex ia IIC T4 Ga

NOTES: FOR MODELS INTEGRAL CABLE SERIES, Ci IS SPECIFIED AT A MAXIMUM CABLE LENGTH OF 500 FT. FOR SHORTER CABLE LENGTHS, Ci IS DECREASED BY 61 pF/FT

UNLESS OTHERWISE SPECIFIED
DIMENSIONS ARE IN INCHES
DECIMALS X ± .05
XX ± .01
XXX ± .005
XXXX ± .0005
ANGLES ± 2 DEGREES
FILLETS AND RADII .003 - .005
HEX DIMENSIONS ARE:
≤ .5 + .000 / - .003
> .5 + .000 / - .005
INTERNAL THREAD DEPTH MIN.
REMOVE ALL BURRS
SHARP = R.000 - R.003

DRAWN	CHECKED	ENGINEER
KSR 2/17/20		GGS 2/17/20

TITLE
**APPROVAL
EX(TO)(M)60X SERIES
INTERCONNECTION**

PCB PIEZOTRONICS™
3425 WALDEN AVE. DEPEW, NY 14043
(716) 684-0002 E-MAIL: sales@pcb.com

CODE IDENT. NO. 52681	DWG. NO. 64371
SCALE: NONE	SHEET 1 OF 2

PCB Piezotronics Inc. claims proprietary rights in the information disclosed hereon. Neither it nor any reproduction thereof will be disclosed to others without the written consent of PCB Piezotronics Inc.

64371

SCHEDULE DRAWING

NO MODIFICATIONS PERMITTED WITHOUT REFERENCE TO THE NOTIFIED BODY

REVISIONS

REV	DESCRIPTION	DIN
	-SEE SHEET 1-	

APPROVED
POWER SUPPLY/
SIGNAL CONDITIONER

NON-HAZARDOUS / SAFE AREA
ZONE 2

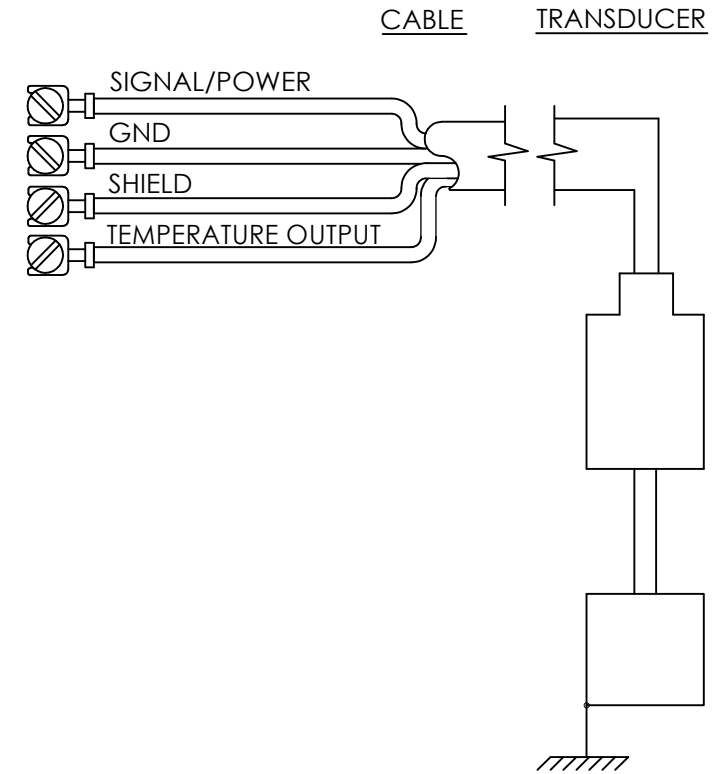
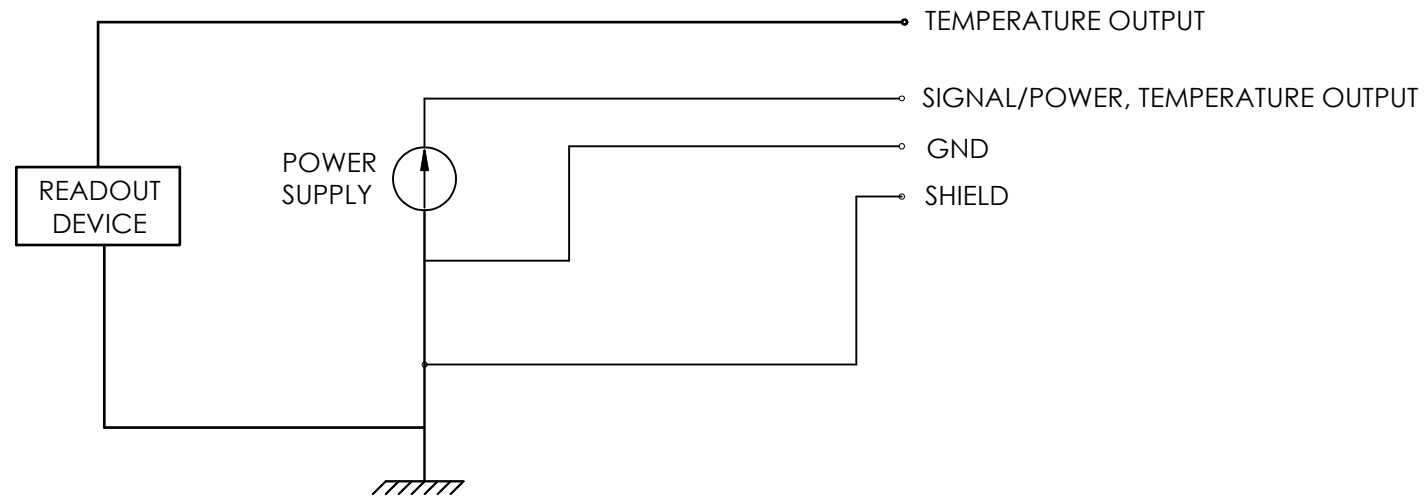

2.) MAXIMUM VOLTAGE OF POWER SUPPLY/SIGNAL CONDITIONER NEVER TO EXCEED 250 Vrms.

1.) CERTIFIED BY THE APPROPRIATE APPROVAL AUTHORITY FOR CONNECTION TO THE FOLLOWING AREAS:

ZONE 2
Ex nA IIC T4 Gc

NOTES: FOR MODELS INTEGRAL CABLE SERIES, Ci IS SPECIFIED AT A MAXIMUM CABLE LENGTH OF 500 FT. FOR SHORTER CABLE LENGTHS, Ci IS DECREASED BY 61 pF/FT.

UNLESS OTHERWISE SPECIFIED	
DIMENSIONS ARE IN INCHES	
DECIMALS	X ± .05
	XX ± .01
	XXX ± .005
	XXXX ± .0005
ANGLES ± 2 DEGREES	
FILLETS AND RADII .003 - .005	
HEX DIMENSIONS ARE:	
	≤ .5 + .000 / - .003
	> .5 + .000 / - .005
INTERNAL THREAD DEPTH MIN.	
REMOVE ALL BURRS	
SHARP = R.000 - R.003	

DRAWN	CHECKED	ENGINEER
KSR 2/17/20		GGG 2/17/20

TITLE
**APPROVAL
EX(TO)(M)60X SERIES
INTERCONNECTION**

PCB PIEZOTRONICS™
3425 WALDEN AVE. DEPEW, NY 14043
(716) 684-0002 E-MAIL: sales@pcb.com

CODE IDENT. NO. 52681	DWG. NO. 64371
SCALE: NONE	SHEET 2 OF 2

PCB Piezotronics Inc. claims proprietary rights in the information disclosed hereon. Neither it nor any reproduction thereof will be disclosed to others without written consent of PCB Piezotronics Inc.

29876

Schedule Drawing
No modifications permitted
without reference to the
Notified Body

REVISIONS	
REV	DESCRIPTION
C	UPDATED NOTE 1
ECN	49662

VIN \leq +24 VOLTS

SINGLE CHANNEL

CABLE

NON-HAZARDOUS / SAFE AREA

HAZARDOUS AREA
DIV 1
ZONE 0

TRANSDUCER

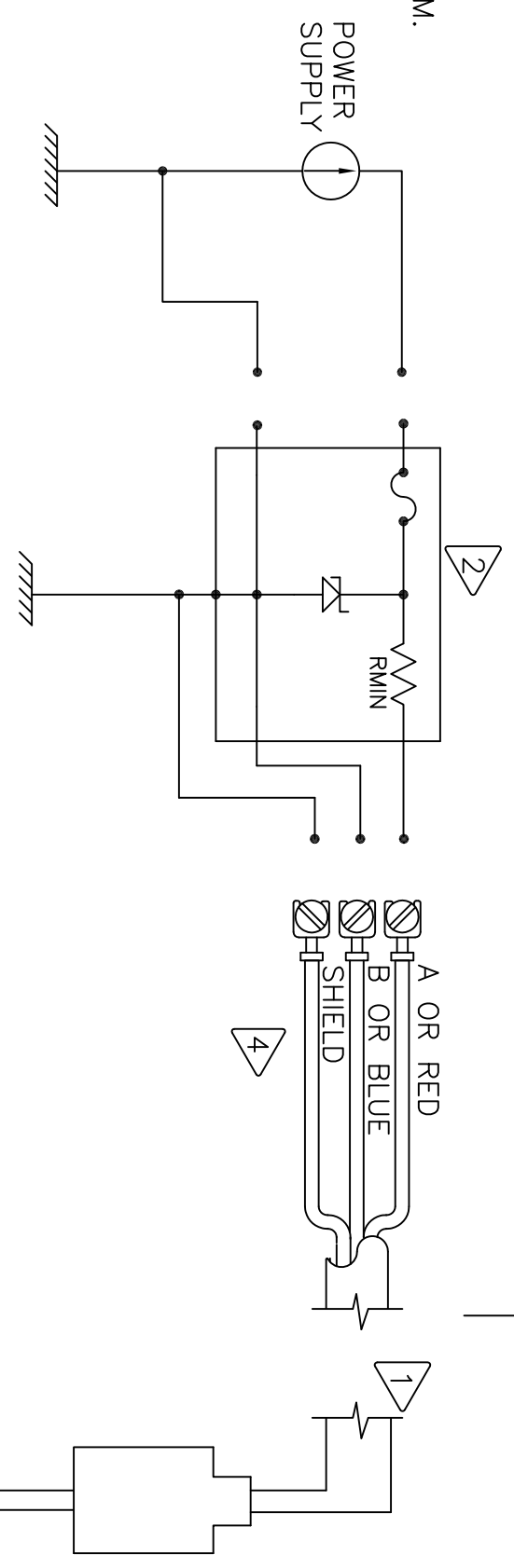

4 SHIELDS TO BE EARTHED AT BARRIER ENDS.

3 THE INSTALLER SHALL INSURE THAT THE TRANSDUCER MOUNTING STRUCTURE IS AT THE SAME GROUNDING POTENTIAL AS THE BARRIER GROUND. TOTAL EARTH LOOP IMPEDANCE SHALL BE LESS THAN 1 OHM.

2 BARRIER WILL BE MOUNTED IN AN ENCLOSURE THE SUITABILITY OF WHICH WILL BE DETERMINED BY LOCAL AUTHORITIES.

1 ENTITY APPLICATION

BARRIER		I.S. APPARATUS	
Voc/Uo	\leq	V _{Max} / UI	
Isc/Io	\leq	I _{Max} / II	
Ca/Co	$>$	CI + Co _{CABLE}	
Ld/Lo	$>$	LI + Lo _{CABLE}	
Po	\leq	PI (CENELEC ONLY)	

BARRIERS WITHIN THE SPECIFIED LIMITATIONS ARE PERMITTED

ENTITY PARAMETERS

CONNECTOR VERSION		INTEGRAL CABLE VERSION	
Ui = 28V		Ui = 28V	
Ii = 93 mA		Ii = 93 mA	
Pi = 0.65 W		Pi = 0.65 W	
Ci = 46.5 nF		Ci = 77 nF	
Li = 0 μH		Li = 152.5 μH	

CERTIFIED BY THE APPROPRIATE APPROVAL AUTHORITY FOR CONNECTION TO THE FOLLOWING AREAS:

- ZONE 0
- Exia IIC
- AExia IIC
- DIV 1
- CLASS I, GROUPS A,B,C,D
- CLASS II, GROUPS E,F,G
- CLASS III

NOTES: FOR INTEGRAL CABLE MODELS, CI IS SPECIFIED AT A MAXIMUM CABLE LENGTH OF 500 FT. FOR SHORTER CABLE LENGTHS, CI IS DECREASED BY 61 pF/FT.

NO CHANGES WITHOUT CSA APPROVAL

UNLESS OTHERWISE SPECIFIED
DIMENSIONS ARE IN INCHES
DECIMALS X ± .05
XX ± .01
XXX ± .005
XXXX ± .0005
ANGLES ±2 DEGREES
FILETS AND RADII .003 - .005
HEX DIMENSIONS ARE:
< 0.5 + .000 / -.003
> 0.5 + .000 / -.005
INTERNAL THREAD DEPTH MIN
REMOVE ALL BURRS
SHARP = R.000 - R.003

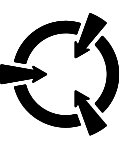

CAUTION
ELECTROSTATIC
DISCHARGE SENSITIVE

DRAWN	CHECKED	ENGINEER
KSR 8/7/19	JDM 8/7/19	GGG 8/7/19

CSA APPROVAL
INTERCONNECTION

PCB PIEZOTRONICS
3425 WALDEN AVE. DEPEW, NY 14043
(716) 684-0001 EMAIL: SALES@PCB.COM

CODE IDENT. NO. 52681
DWG. NO. 29876
SCALE: NONE SHEET 1 OF 2

PCB Piezotronics Inc. claims proprietary rights in the information disclosed hereon. Neither it nor any reproduction thereof will be disclosed to others without written consent of PCB Piezotronics Inc.

29876

Schedule Drawing

No modifications permitted without reference to the Notified Body

REVISIONS		ECN
REV	DESCRIPTION	
	- SEE SHEET 1 -	

APPROVED
POWER SUPPLY/
SIGNAL CONDITIONER

NON-HAZARDOUS / SAFE AREA
OR DIV 2 / ZONE 2

CABLE _____

TRANSDUCER _____

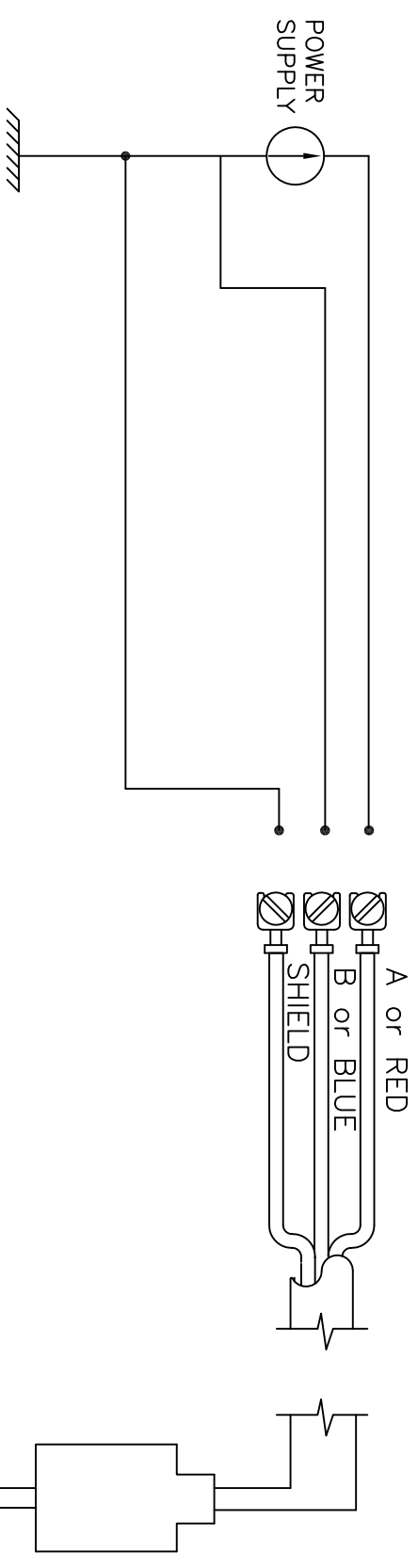

- FOR CANADIAN, DIVISION 2 AND ZONE 2 INSTALLATION, POWER SUPPLY MUST BE CSA CERTIFIED WITH ENTITY OUTPUT PARAMETERS (SEE PAGE 1, NOTE 1 FOR POWER SUPPLY OUTPUT PARAMETERS).
- FOR U.S. DIVISION 2 AND ZONE 2 INSTALLATION, POWER SUPPLY MUST BE APPROVED BY NRTL WITH ENTITY OUTPUT PARAMETERS (SEE PAGE 1 NOTE 1 FOR POWER SUPPLY OUTPUT PARAMETERS).

ENTITY PARAMETERS:

CONNECTOR VERSION

$U_i = 28 \text{ V}$
 $I_i = 93 \text{ mA}$
 $P_i = 0.65 \text{ W}$
 $C_i = 46.5 \text{ nF}$
 $L_i = 0 \text{ } \mu\text{H}$

INTEGRAL CABLE VERSION

$U_i = 28 \text{ V}$
 $I_i = 93 \text{ mA}$
 $P_i = 0.65 \text{ W}$
 $C_i = 77 \text{ nF}$
 $L_i = 152.5 \text{ } \mu\text{H}$

- MAXIMUM VOLTAGE OF POWER SUPPLY/SIGNAL CONDITIONER NEVER TO EXCEED 250 Vrms.
- FOR GUIDANCE ON CANADIAN INSTALLATION, REFER TO CEC PART 1.
- FOR GUIDANCE ON U.S. INSTALLATION, INSTALL IN ACCORDANCE WITH NEC [ANSI/NFPA70] AND [ANSI/ISA RP12.6].

NO CHANGES WITHOUT CSA APPROVAL

- CERTIFIED BY THE APPROPRIATE APPROVAL AUTHORITY FOR CONNECTION TO THE FOLLOWING AREAS:

ZONE 2

Exnl IIC, AExna IIC T4

DIV 2

CLASS 1, GROUPS A, B, C, D

NOTES: FOR INTEGRAL CABLE MODELS, C_i IS SPECIFIED AT A MAXIMUM CABLE LENGTH OF 500 FT. FOR SHORTER CABLE LENGTHS, C_i IS DECREASED BY 61 pF/FT.

UNLESS OTHERWISE SPECIFIED
DIMENSIONS ARE IN INCHES
DECIMALS X ± .05
FRACTIONS XX ± .01
XXX ± .005
XXXX ± .0005
ANGLES ±2 DEGREES
FILETS AND RADII .003 - .005
HEX DIMENSIONS ARE:
< 0.5 + .000 / -.003
> 0.5 + .000 / -.005
INTERNAL THREAD DEPTH MIN
REMOVE ALL BURRS
SHARP = R.000 - R.003

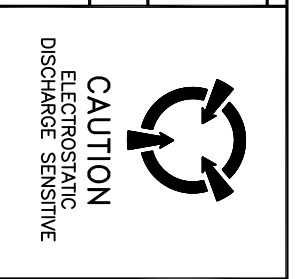

DRAWN	CHECKED	ENGINEER
KSR 8/7/19	JDM 8/7/19	GGG 8/7/19

CSA APPROVAL
INTERCONNECTION

PCB PIEZOTRONICS
 3425 WALDEN AVE. DEPEW, NY 14043
 (716) 684-0001 EMAIL: SALES@PCB.COM

CODE IDENT. NO. 52681
 DWG. NO. 29876
 SCALE: NONE SHEET 2 OF 2



ATTESTATION D'EXAMEN DE TYPE

TYPE EXAMINATION CERTIFICATE



1 Version : 03

LCIE 06 ATEX 6032 X

Issue : 03

- | | |
|--|--|
| <p>2 Appareil ou Système de Protection destiné à être utilisé en Atmosphères Explosibles</p> <p>3 Produit :
Capteurs de vibration</p> <p>4 Fabricant :</p> <p>5 Adresse :</p> <p>6 Ce produit et ses variantes éventuelles acceptées sont décrits dans l'annexe de la présente attestation et dans les documents descriptifs cités en référence.</p> <p>7 Le LCIE certifie que ce produit est conforme aux Exigences Essentielles de Sécurité et de Santé pour la conception et la construction de produits destinés à être utilisés en atmosphères explosibles, données dans l'annexe II de la Directive.
Les résultats des vérifications et essais figurent dans le(s) rapport(s) confidentiel(s) N° :</p> <p>8 Le respect des Exigences Essentielles de Sécurité et de Santé est assuré par la conformité à :</p> <p>9 Le signe « X » lorsqu'il est placé à la suite du numéro de l'attestation, indique que cet appareil est soumis aux conditions particulières d'utilisation, mentionnées dans l'annexe de cette attestation.</p> <p>10 Cette Attestation d'Examen de Type concerne uniquement la conception et la construction du produit spécifié.
Des exigences supplémentaires de la directive sont applicables pour la fabrication et la fourniture du produit. Ces dernières ne sont pas couvertes par la présente attestation.</p> <p>11 Le marquage du produit est mentionné dans l'annexe de cette attestation.</p> | <p>Equipment or Protective System Intended for use in Potentially Explosive Atmospheres</p> <p>Product :
Vibration sensors</p> <p>Manufacturer :
PCB Piezotronics Inc.
Address :
3425 Walden Avenue
Depew, New York 14043
USA</p> <p>This product any acceptable variation thereto is specified in the schedule to this certificate and the documents therein referred to.</p> <p>LCIE certifies that product has been found to comply with the Essential Health and Safety Requirements relating to the design and construction of products intended for use in potentially explosive atmospheres, given in Annex II to the Directive.
The examination and test results are recorded in confidential report(s) N°:
60042410/542370, 95367-590025-01, 120351-640382, 141243-684381.</p> <p>Compliance with the Essential Health and Safety Requirements has been assured by compliance with :
EN 60079-0:2012 + A11:2013, EN 60079-15:2010</p> <p>If the sign "X" is placed after the certificate number, it indicates that the product is subject to the Specific Conditions of Use specified in the schedule to this certificate.</p> <p>This Type Examination Certificate relates only to the design and construction of the specified product.
Further requirements of the Directive apply to the manufacturing process and supply of this product. These are not covered by this certificate.</p> <p>The marking of the product is specified in the schedule to this certificate.</p> |
|--|--|

Fontenay-aux-Roses, le 27 mars 2017

Responsable de Certification
Certification Officer

Julien Gauthier

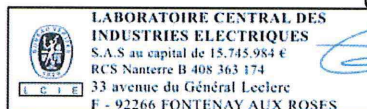

Seul le texte en français peut engager la responsabilité du LCIE. Ce document ne peut être reproduit que dans son intégralité, sans aucune modification. Il est établi en accord avec le référentiel de certification ATEX du LCIE. The LCIE's liability applies only on the French text. This document may only be reproduced in its entirety and without any change. It is issued in accordance with LCIE's ATEX Certification Rules.
CERT-ATEX-FORM 05 Rev. 02

Page 1 of 4

LCIE

Laboratoire Central des Industries Electriques
Une société de Bureau Veritas

33 Avenue du Général Leclerc
92260 Fontenay-aux-Roses
FRANCE

WWW.LCIE.FR



ATTESTATION D'EXAMEN DE TYPE - ANNEXE

TYPE EXAMINATION CERTIFICATE - SCHEDULE

1 Version : 03

LCIE 06 ATEX 6032 X

Issue : 03

12 DESCRIPTION DU PRODUIT

Les capteurs de vibration piézoélectriques EX(XX)602yzzz/aaa, EX(XX)603yzzz/aaa, EX(XX)606yzzz/aaa, EX(XX)607yzzz/aaa et EX(XX)608yzzz/aaa utilisent un cristal de quartz pour convertir une mesure de vibration mécanique en un signal électrique.

Le capteur se compose d'un boîtier métallique cylindrique scellé qui abrite une carte de substrat PCB et un élément piézo-cristal. Le circuit est relié à un connecteur ou à un câble intégré.

Paramètres électriques :

$U \leq 28V, I \leq 200mA, P \leq 1W$

DETAIL DE LA GAMME

Les modèles sont électriquement identiques, mais mécaniquement différents:

EX(XX)602yzzz/aaa, EX(XX)607yzzz/aaa et EX(XX)606yzzz/aaa : Capteur avec connecteur ou câble intégré de sortie latérale,
EX(XX)603yzzz/aaa: Capteur avec connecteur ou câble intégré de sortie dirigée vers le haut,
EX(XX)608yzzz/aaa: Capteur avec câble intégré de sortie dirigée vers le haut.

DESCRIPTION OF PRODUCT

The EX(XX)602yzzz/aaa, EX(XX)603yzzz/aaa, EX(XX)606yzzz/aaa, EX(XX)607yzzz/aaa and EX(XX)608yzzz/aaa piezoelectric vibration sensors utilize a quartz crystal to convert a mechanical vibration measurement into an electric signal.

The sensor consists of a sealed cylindrical metal case which houses a PCB substrate board and a piezo-crystal element. The circuit is connected to a connector or an integral cable.

Electrical parameters:

RANGE DETAILS

Models are electrically identical, but mechanically different:

EX(XX)602yzzz/aaa, EX(XX)607yzzz/aaa and EX(XX)606yzzz/aaa: Sensor with side exit connector or integral cable,
EX(XX)603yzzz/aaa: Sensor with top exit connector or integral cable,
EX(XX)608yzzz/aaa: Sensor with top exit integral cable.

Symbole Symbol	Détail Detail	
XX	M	Câble et matériel de montage métrique <i>Metric mounting hardware and cable</i>
	TO	Capteur de température de sortie <i>Temperature Output Sensor</i>
y	Une lettre de A à Z <i>One letter A to Z</i>	
zzz	Deux ou trois chiffres de 00 à 999 <i>Two or three numbers 00 to 999</i>	
aaa	Longueur de câble et/ou type de connecteur <i>Cable length and/or connector type</i>	

MARQUAGE

Le marquage du produit doit comprendre :

Marquage complet :

PCB Piezotronics Inc. ou IMI sensors ou IMI
Adresse : ...
Type : ...
Numéro de fabrication : ...
Année de construction : ...

II 3 G

Ex nA IIC T4 Gc
LCIE 06 ATEX 6032 X
 $-54^{\circ}C \leq T_{amb} \leq +121^{\circ}C$

AVERTISSEMENT – NE PAS SEPARER SOUS TENSION

MARKING

The marking of the product shall include the following :

Full marking:

PCB Piezotronics Inc. or IMI sensors or IMI
Address: ...
Type: ...
Serial number: ...
Year of construction: ...

II 3 G

Ex nA IIC T4 Gc
LCIE 06 ATEX 6032 X
 $-54^{\circ}C \leq T_{amb} \leq +121^{\circ}C$

WARNING – DO NOT SEPARATE WHEN ENERGIZED

Seul le texte en français peut engager la responsabilité du LCIE. Ce document ne peut être reproduit que dans son intégralité, sans aucune modification. Il est établi en accord avec le référentiel de certification ATEX du LCIE. The LCIE's liability applies only on the French text. This document may only be reproduced in its entirety and without any change. It is issued in accordance with LCIE's ATEX Certification Rules.
CERT-ATEX-FORM 05 Rev. 02

Page 2 of 4

LCIE

Laboratoire Central des Industries Electriques
Une société de Bureau Veritas

33 Avenue du Général Leclerc
92260 Fontenay-aux-Roses
FRANCE

WWW.LCIE.FR



L C I E

1 AVENANT D'ATTESTATION D'EXAMEN DE TYPE VOLONTAIRE

2 Appareil ou système de protection destiné à être utilisé en atmosphères explosibles (Directive 94/9/CE)

**3 Numéro de l'avenant :
LCIE 06 ATEX 6032 X / 02**

4 Appareil ou système de protection :
Capteur de vibration
Type : EX602Dxx, EX603Cxx, EX606Bxx,
EX607Axx, EX608Axx

**5 Demandeur : IMI Sensors
A PCB Piezoelectric Div.**

1 SUPPLEMENTARY VOLUNTARY TYPE EXAMINATION CERTIFICATE

2 Equipment or protective system intended for use in potentially explosive atmospheres (Directive 94/9/EC)

**3 Supplementary certificate number :
LCIE 06 ATEX 6032 X / 02**

4 Equipment or protective system :
Vibration sensor
Type : EX602Dxx, EX603Cxx, EX606Bxx,
EX607Axx, EX608Axx

**5 Applicant : IMI Sensors
A PCB Piezoelectric Div.**

15 DESCRIPTION DE L'AVENANT

Mise à jour normative suivant les normes EN 60079-0:2012 et EN 60079-15:2010.

Mise à jour des documents.

Les résultats des vérifications et essais figurent dans le rapport confidentiel N°120351-640382.

Paramètres spécifiques du ou des modes de protection concerné(s) :
Inchangés.

Le marquage doit être : Modifié comme suit :
IMI Sensors Adresse : ...
Type : EX602Dxx, EX603Cxx, EX606Bxx, EX607Axx,
EX608Axx (1)
Numéro de fabrication : ... Année de fabrication : ...

⊕ II 3 G
Ex nA IIC T4 Gc
LCIE 06 ATEX 6032 X
-40°C ≤ Ta ≤ +121°C
(1) complété avec le modèle

16 DOCUMENTS DESCRIPTIFS

Dossier technique n°33701 rev.B du 18/04/2013.
Ce dossier comprend 10 rubriques (25 pages).

17 CONDITIONS SPECIALES POUR UNE UTILISATION SURE

Inchangées.

18 EXIGENCES ESSENTIELLES DE SECURITE ET DE SANTE

Couvertes par les normes EN 60079-0:2009 et EN 60079-15:2010.

19 VERIFICATIONS ET ESSAIS INDIVIDUELS

Inchangés.

Fontenay-aux-Roses, le **20 AOUT 2013**

15 DESCRIPTION OF THE SUPPLEMENTARY CERTIFICATE

Normative update according standards EN 60079-0:2012 and EN 60079-15:2010.

Update of documents.

The examination and test results are recorded in confidential report N°120351-640382.

Specific parameters of the concerned protection mode :
Unchanged.

The marking shall be : Modified as follow :
IMI Sensors Address : ...
Type : EX602Dxx, EX603Cxx, EX606Bxx, EX607Axx,
EX608Axx (1)
Serial number : ... Year of construction : ...

⊕ II 3 G
Ex nA IIC T4 Gc
LCIE 06 ATEX 6032 X
-40°C ≤ Ta ≤ +121°C
(1) completed with the model

16 DESCRIPTIVE DOCUMENTS

Technical file n°33701 rev.B dated 2013/04/18.
This file includes 10 items (25 pages).

17 SPECIAL CONDITIONS FOR SAFE USE

Unchanged.

18 ESSENTIAL HEALTH AND SAFETY REQUIREMENTS

Covered by standards EN 60079-0:2009 and EN 60079-15:2010.

19 ROUTINE VERIFICATIONS AND TESTS

Unchanged.

Le responsable de certification ATEX
ATEX Certification Officer



Seul le texte en français peut engager la responsabilité du LCIE. Ce document ne peut être reproduit en totalité ou en partie, sans aucune modification.
The LCIE's liability applies only on the French text. This document may only be reproduced in its entirety and without any change.

Page 1 sur 1

01A-Annexe III_CE_typ_app_av - rev3.DOC



L C I E

1 AVENANT D'ATTESTATION D'EXAMEN DE TYPE VOLONTAIRE

2 Appareil destiné à être utilisé en atmosphères explosibles (Directive 94/9/CE)

3 Numéro de l'avenant : **LCIE 06 ATEX 6032 X / 01**

4 Appareil

Capteurs de vibrations

Type : EX602Dxx, EX603Cxx, EX606Bxx, EX607Axx, EX608Axx

5 demandeur : IMI Sensors PCB Piezotronics Div.

1 VOLUNTARY SUPPLEMENTARY TYPE EXAMINATION CERTIFICATE

2 Equipment intended for use in potentially explosive atmospheres (Directive 94/9/EC)

3 Supplementary certificate number : **LCIE 06 ATEX 6032 X / 01**

4 Equipment

Vibration sensors

Type : EX602Dxx, EX603Cxx, EX606Bxx, EX607Axx, EX608Axx

5 Applicant : IMI Sensors PCB Piezotronics Div.

15 DESCRIPTION DE L'AVENANT

Mise à jour normative selon les normes EN 60079-0 (2006) et EN 60079-15 (2005).

Les résultats des vérifications et essais figurent dans le rapport confidentiel N° 95367-590025-01.

Paramètres spécifiques du ou des modes de protection concerné(s) :
Inchangés.

Le marquage doit être :

IMI Sensors

Adresse :

Type : EX 60... (1)

N° de fabrication :Année de fabrication :

Ex II 3G Ex nL IIC T4

LCIE 06 ATEX 6032X

T amb. : - 40°C à + 121°C

(1) complété suivant le modèle

15 DESCRIPTION OF THE SUPPLEMENTARY CERTIFICATE

Normative update according to the standards EN 60079-0 (2006) and EN 60079-15 (2005).

The examination and test results are recorded in confidential report N° 95367-590025-01.

Specific parameters of the mode(s) of protection concerned:

Unchanged.

The marking shall be : xxxxxxxx

IMI Sensors

Address :

Type : EX 60... (1)

Serial number :Year of construction :

Ex II 3G Ex nL IIC T4

LCIE 06 ATEX 6032X

T amb. : - 40°C to + 121°C

(1) completed following the model

16 DOCUMENTS DESCRIPTIFS

Dossier de certification n° 33700 rév. A du 19/04/2010. Ce document comprend 10 rubriques (22 pages).

17 CONDITIONS SPECIALES POUR UNE UTILISATION SÛRE
Inchangées.

16 DESCRIPTIVE DOCUMENTS

Certification file n° 33700 Rev. A dated 2010/04/19. This file includes 10 items (22 pages).

17 SPECIAL CONDITIONS FOR SAFE USE
Unchanged.

18 EXIGENCES ESSENTIELLES DE SECURITE ET DE SANTE

Couvertes par les normes listées au point 15.

18 ESSENTIAL HEALTH AND SAFETY REQUIREMENTS

Covered by standards listed at 15.

19 VERIFICATIONS ET ESSAIS INDIVIDUELS

Chaque équipement devra avoir subi avec succès une épreuve de rigidité diélectrique conformément au paragraphe 34.2.1 de la norme EN 60079-15 (2005).

19 ROUTINE VERIFICATIONS AND TESTS

Each equipment shall be submitted to an electric strength test according to paragraph 34.2.1 from EN 60079-15 (2005).

Fontenay-aux-Roses, le le 04 mai 2010.

Le responsable de certification ATEX
ATEX certification manager
Marc GILLAUX

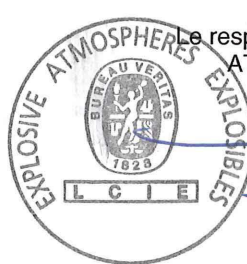

Seul le texte en français peut engager la responsabilité du LCIE. Ce document ne peut être reproduit que dans son intégralité, sans aucune modification.
The LCIE's liability applies only on the French text. This document may only be reproduced in its entirety and without any change.



L C I E

1 ATTESTATION D'EXAMEN DE TYPE

2 Appareil ou système de protection destiné à être utilisé en atmosphères explosibles (Directive 94/9/CE)

3 Numéro de l'attestation d'examen de type
LCIE 06 ATEX 6032 X

4 Appareil ou système de protection :

Capteurs de vibrations

Type : EX602Dxx, EX603Cxx, EX606Bxx, EX607Axx,
EX608Axx

5 Demandeur : IMI Sensors A PCB Piezotronics Div.

Adresse : 3425 Walden Avenue
Depew, New York 14043 USA

7 Cet appareil ou système de protection et ses variantes éventuelles acceptées sont décrits dans l'annexe de la présente attestation et dans les documents descriptifs cités en référence.

8 Le LCIE certifie que cet appareil ou système de protection est conforme aux exigences essentielles de sécurité et de santé pour la conception et la construction d'appareils et de systèmes de protection destinés à être utilisés en atmosphères explosibles, données dans l'annexe II de la directive 94/9/CE du Parlement européen et du Conseil du 23 mars 1994.

Les résultats des vérifications et essais figurent dans le rapport confidentiel N° 60042410/542370.

9 Le respect des exigences essentielles de sécurité et de santé est assuré par la conformité à :

- EN 60075-15 (2005)

10 Le signe X lorsqu'il est placé à la suite du numéro de l'attestation, indique que cet appareil ou système de protection est soumis aux conditions spéciales pour une utilisation sûre, mentionnées dans l'annexe de la présente attestation.

11 Cette attestation d'examen de type concerne uniquement la conception et la construction de l'appareil ou du système de protection spécifié, conformément à l'annexe III de la directive 94/9/CE.

Des exigences supplémentaires de la directive sont applicables pour la fabrication et la fourniture de l'appareil ou du système de protection. Ces dernières ne sont pas couvertes par la présente attestation.

12 Le marquage de l'appareil ou du système de protection doit comporter les informations détaillées au point 15.

1 TYPE EXAMINATION CERTIFICATE

2 Equipment or protective system intended for use in potentially explosive atmospheres (Directive 94/9/EC)

3 Type Examination Certificate number
LCIE 06 ATEX 6032 X

4 Equipment or protective system :

Vibration sensors

Type : EX602Dxx, EX603Cxx, EX606Bxx, EX607Axx,
EX608Axx

5 applicant : IMI Sensors A PCB Piezotronics Div.

Address : 3425 Walden Avenue
Depew, New York 14043 USA

7 This equipment or protective system and any acceptable variation thereto is specified in the schedule to this certificate and the documents therein referred to.

8 LCIE certifies that this equipment or protective system has been found to comply with the essential Health and Safety Requirements relating to the design and construction of equipment and protective system intended for use in potentially explosive atmospheres, given in Annex II of the Directive 94/9/EC of the European Parliament and Council of 23 March 1994.

The examination and test results are recorded in confidential report N° 60042410/542370.

9 Compliance with the Essential Health and Safety Requirements has been assured by compliance with :

- EN 60079-15 (2005)

10 If the sign X is placed after the certificate number, it indicates that the equipment or protective system is subject to special conditions for safe use specified in the schedule to this certificate.

11 This type examination certificate relates only to the design and construction of this specified equipment or protective system in accordance with annex III to the directive 94/9/EC.

Further requirements of the Directive apply to the manufacture and supply of this equipment or protective system. These are not covered by this certificate.

12 The marking of the equipment or protective system shall include informations as detailed at 15.

Fontenay-aux-Roses, le 22 mai 2006

Le responsable de certification ATEX
ATEX certification manager

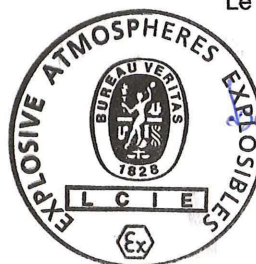

Henri CERVELLO
Henri CERVELLO

Seul le texte en français peut engager la responsabilité du LCIE. Ce document ne peut être reproduit que dans son intégralité, sans aucune modification
The LCIE's liability applies only on the French text. This document may be reproduced in its entirety and without any change

LCIE 33, av du Général Leclerc
Laboratoire Central BP 8
des Industries Electriques 92266 Fontenay-aux-Roses cedex
Une société de Bureau Veritas France

Tél : +33 1 40 95 60 60 Société Anonyme
Fax : +33 1 40 95 86 56 au capital de 15 745 984 €
contact@lcie.fr RCS Nanterre B 408 363 174
www.lcie.fr

13 ANNEXE

13 SCHEDULE

14 ATTESTATION D'EXAMEN DE TYPE

14 TYPE EXAMINATION CERTIFICATE

LCIE 06 ATEX 6032 X

LCIE 06 ATEX 6032 X

15 DESCRIPTION DE L'APPAREIL OU DU SYSTEME DE PROTECTION

15 DESCRIPTION OF EQUIPMENT OR PROTECTIVE SYSTEM

Capteurs de vibrations

Vibration sensors

Type : EX602Dxx, EX603Cxx, EX606Bxx, EX607Axx, EX608Axx

Type : EX602Dxx, EX603Cxx, EX606Bxx, EX607Axx, EX608Axx

Ce capteur est composé d'un ensemble piezo-cristal, d'une carte électronique et d'un connecteur ou un câble intégré.

This apparatus is made of a piezo-crystal assembly, an electronic board and a connector or an integrated cable.

Modèles concernés :

Models concerned :

EX602D01,EX603C01,EX606B01,EX607A01
EX602D11,EX603C11,EX606B11,EX607A11,EX608A11
EX602D61,EX603C61,EX606B61,EX607A61

EX602D01,EX603C01,EX606B01,EX607A01
EX602D11,EX603C11,EX606B11,EX607A11,EX608A11
EX602D61,EX603C61,EX606B61,EX607A61

Paramètres spécifiques du ou des modes de protection concernés :

Specific parameters of the modes(s) of protection concerned :

Modèle / Model	U (V)	I (mA)	P (W)
EX602D01,EX603C01,EX606B01,EX607A01	28	200	1
EX602D11,EX603C11,EX606B11,EX607A11,EX608A11	28	200	1
EX602D61,EX603C61,EX606B61,EX607A61	28	200	1

Le marquage doit être :

The marking shall be :

IMI Adresse :

IMI Address :

Type : EX 60... (1)

Type : EX 60... (1)

N° de fabrication :Année de fabrication :

Serial number :Year of construction :

II 3G EEx nL IIC T4

II 3G EEx nL IIC T4

LCIE 06 ATEX 6032X

LCIE 06 ATEX 6032X

T amb. : - 40°C à + 121°C

T amb. : - 40°C to + 121°C

(1) complété suivant le modèle

(1) completed following the model

L'appareil doit également comporter le marquage normalement prévu par les normes de construction qui le concerne.

The equipment shall also bear the usual marking required by the manufacturing standards applying to such equipment.

16 DOCUMENTS DESCRIPTIFS

16 DESCRIPTIVE DOCUMENTS

Dossier de certification N° 33701 du 28/03/2006.
Ce document comprend 10 rubriques (25 pages).

Certification file N° 33701 dated 28/03/2006.
This file includes 10 items (25 pages).

17 CONDITIONS SPECIALES POUR UNE UTILISATION SÛRE

17 SPECIAL CONDITIONS FOR SAFE USE

Ce matériel ne peut être placé qu'en atmosphère explosible zone 2.

This equipment can be only mounted in explosive atmosphere zone 2.

Le matériel ne doit être raccordé qu'à un équipement dont les paramètres électriques sont compatibles aux valeurs mentionnées au paragraphe 15.

The apparatus must be only connected to an equipment whose electrical parameters are compatible with the values mentioned clause 15.

Température ambiante d'utilisation : - 40°C à + 121°C.

Operating ambient temperature : - 40°C to + 121°C.

18 EXIGENCES ESSENTIELLES DE SECURITE ET DE SANTE

18 ESSENTIAL HEALTH AND SAFETY REQUIREMENTS

Couvertes par les normes listées au point 9.

Covered by standards listed at 9.

19 VERIFICATIONS ET ESSAIS INDIVIDUELS

19 ROUTINE VERIFICATIONS AND TESTS

Néant.

None.



IECEx Certificate of Conformity

INTERNATIONAL ELECTROTECHNICAL COMMISSION IEC Certification System for Explosive Atmospheres

for rules and details of the IECEx Scheme visit www.iecex.com

Certificate No.: **IECEx LCIE 13.0045X** Page 1 of 4 Certificate history:
Status: **Current** Issue No: 3 Issue 2 (2017-03-27)
Date of Issue: 2020-03-27 Issue 1 (2015-11-09)
Issue 0 (2013-08-20)
Applicant: **IMI Sensors, a PCB Piezotronics Division**
3425 Waiden Avenue
Depew, New-York 14043
United States of America
Equipment: **Vibration Sensors - Type: EX(XX)602yzzz/aaa, EX(XX)603yzzz/aaa, EX(XX)606yzzz/aaa, EX(XX)607yzzz/aaa, EX(XX)608yzzz/aaa**
Optional accessory:
Type of Protection: **Ex ia, Ex nA**
Marking: Ex ia IIC T4 Ga
Ex nA IIC T4 Gc
Refer to attachment for full marking.

Approved for issue on behalf of the IECEx
Certification Body:

Julien GAUTHIER

Position:

Certification Officer

Signature:
(for printed version)

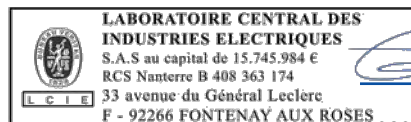

Julien Gauthier
2020-03-27

Date:

1. This certificate and schedule may only be reproduced in full.
2. This certificate is not transferable and remains the property of the issuing body.
3. The Status and authenticity of this certificate may be verified by visiting www.iecex.com or use of this QR Code.



Certificate issued by:

Laboratoire Central des Industries Electriques (LCIE)
33 Avenue du General Leclerc
FR-92260 Fontenay-aux-Roses
France





IECEX Certificate of Conformity

Certificate No.: **IECEX LCIE 13.0045X**

Page 2 of 4

Date of issue: 2020-03-27

Issue No: 3

Manufacturer: **IMI Sensors, a PCB Piezotronics Division**
3425 Waiden Avenue
Depew, New-York 14043
United States of America

Additional
manufacturing
locations:

This certificate is issued as verification that a sample(s), representative of production, was assessed and tested and found to comply with the IEC Standard list below and that the manufacturer's quality system, relating to the Ex products covered by this certificate, was assessed and found to comply with the IECEx Quality system requirements. This certificate is granted subject to the conditions as set out in IECEx Scheme Rules, IECEx 02 and Operational Documents as amended

STANDARDS :

The equipment and any acceptable variations to it specified in the schedule of this certificate and the identified documents, was found to comply with the following standards

IEC 60079-0:2011 Explosive atmospheres - Part 0: General requirements
Edition:6.0

IEC 60079-11:2011 Explosive atmospheres - Part 11: Equipment protection by intrinsic safety "i"
Edition:6.0

IEC 60079-15:2010 Explosive atmospheres - Part 15: Equipment protection by type of protection "n"
Edition:4

This Certificate **does not** indicate compliance with safety and performance requirements other than those expressly included in the Standards listed above.

TEST & ASSESSMENT REPORTS:

A sample(s) of the equipment listed has successfully met the examination and test requirements as recorded in:

Test Reports:

[FR/LCIE/ExTR13.0040/00](#)
[FR/LCIE/ExTR20.0015/00](#)

[FR/LCIE/ExTR15.0110/00](#)
[FR/LCIE/ExTR20.0021/00](#)

[FR/LCIE/ExTR17.0015/00](#)

Quality Assessment Report:

[NL/DEK/QAR14.0004/04](#)



IECEx Certificate of Conformity

Certificate No.: **IECEx LCIE 13.0045X**

Page 3 of 4

Date of issue: 2020-03-27

Issue No: 3

EQUIPMENT:

Equipment and systems covered by this Certificate are as follows:

The EX(XX)602yzzz/aaa, EX(XX)603yzzz/aaa, EX(XX)606yzzz/aaa, EX(XX)607yzzz/aaa and EX(XX)608yzzz/aaa piezoelectric vibration sensors utilize a quartz crystal to convert a mechanical vibration measurement into an electric signal.

The sensor consists of a sealed cylindrical metal case which houses a pcb substrate board and a piezo-crystal element.

The circuit is connected to a connector or an integral cable.

See attachment for more details.

SPECIFIC CONDITIONS OF USE: YES as shown below:

Version Ex ia:

- The intrinsically safe apparatus shall only be connected to associated intrinsically safe apparatus certified for the intended use. This association shall comply with the requirements of the IEC 60079-25 standard .
- Operating ambient temperature: -54°C to + 121°C.
- The apparatus shall be connected according to instruction manual.
- The mounting of the apparatus into an installation must be carried out in such a way that metallic body of the sensor is reliably connected to the system earth.

Version Ex nA:

- The apparatus must be only connected to an external source with $U \leq 28V$, $I \leq 200mA$, $P \leq 1W$.
- For final installation, the user shall take all necessary precautions to maintain the minimum degree of protection IP54 of the sensor connection according to IEC 60079-0 when connected according to the requirements of IEC 60079-14 standard.
- Operating ambient temperature: -54°C to +121°C.
- The apparatus must be connected according to instruction manual.
- WARNING – DO NOT SEPARATE WHEN ENERGIZED.



IECEx Certificate of Conformity

Certificate No.: **IECEx LCIE 13.0045X**

Page 4 of 4

Date of issue: 2020-03-27

Issue No: 3

DETAILS OF CERTIFICATE CHANGES (for issues 1 and above)

Issue 00:

- Conformity assessment according to IEC 60079-0:2011, IEC 60079-11:2011 and IEC 60079-15:2010 standards.

Issue 01:

- Modification of the QAR.
- Modification of the manufacturing site.
- Modification of the applicant name.

Issue 02:

- Addition of a new option of temperature output.
- Update of the nomenclature of the models.
- Distinction between the name of the manufacturer (PCB Piezotronics Inc.) and the name of the trademark (IMI sensors or IMI).
- Change of the low ambient temperature from -40°C to -54°C.

Issue 03:

- Addition of 3 capacitors.
- Reduction of the connection cable length.
- Update of the intrinsic safe electrical parameters.

Annex:

[Annex to Certificate IECEx LCIE 13.0045X issue 03.pdf](#)



Annex to Certificate IECEX LCIE 13.0045X issue 03



MARKING

Full marking:

PCB Piezotronic Inc. or IMI Sensors or IMI
 Address: ...
 Type: ...
 Serial number: ...
 Year of construction: ...
 Ex ia IIC T4 Ga
 Ex nA IIC T4 Gc
 $-54^{\circ}\text{C} \leq T_{\text{amb}} \leq +121^{\circ}\text{C}$
 IECEX LCIE 13.0045 X
 $U_i : \dots \text{V}, I_i : \dots \text{mA}, P_i : \dots \text{W}, C_i : \dots \text{nF}, L_i : \dots \mu\text{H}$ (completed with electrical parameters)
 WARNING – DO NOT SEPARATE WHEN ENERGIZED.

Reduced marking:

PCB Piezotronic Inc. or IMI Sensors or IMI
 Type: ...
 Serial number: ...
 Year of construction: ...
 Ex ia IIC T4 Ga
 Ex nA IIC T4 Gc
 $T_a = 121^{\circ}\text{C}$
 IECEX LCIE 13.0045X

RANGE DETAILS

Models are electrically identical, but mechanically different:

EX(XX)602yzzz/aaa EX(XX)607yzzz/aaa EX(XX)606yzzz/aaa	Sensor with side exit connector or integral cable
EX(XX)603yzzz/aaa EX(XX)608yzzz/aaa	Sensor with top exit connector or integral cable Sensor with top exit integral cable

Symbol	Detail
XX	M: Metric mounting fastener option TO: Temperature Output Sensor option
y	One letter A to Z for model revision level
z	Special order
z	Sensitivity range (for example: 1 = 100mV/g)
z	0 = 2-pin Military Connector
	1 = Integral polyurethane jacketed cable
	2 = Integral FEP jacketed cable
	3 = Bayonet Military Connector
	4 = 10-32 top exit
	5 = 10-32 side exit
	6 = Integral armored polyurethane jacketed cable
	7 = Terminal block
	8 = Mini Military Connector
	9 = To be determined
aaa	Cable length (for example: 010 = 10 feet)

RATINGS

Version "ia"	Models equipped with	Intrinsic safety parameters
	Connector	$U_i : 28\text{V}, I_i : 120\text{mA}, P_i : 0.84\text{W}, C_i : 46.5\text{nF}, L_i : 0\mu\text{H}$
	Integral armored cable and Integral jacketed cable	$U_i : 28\text{V}, I_i : 120\text{mA}, P_i : 0.84\text{W}, C_i : 77\text{nF}, L_i : 152.5\mu\text{H}^*$
* cable length max 152.5m (500ft)		
Version "nA"	$U \leq 28\text{V}, I \leq 200\text{mA}, P \leq 1\text{W}$	

ROUTINE TESTS

Version "ia"	None.
Version "nA"	Each apparatus shall be submitted to a dielectric strength test under 600 Volts during 100ms according to clause 23.2.1 of IEC 60079-15 standard.

APPARATUS OVERVIEW



EX(XX)602yzzz/aaa



EX(XX)603yzzz/aaa



EX(XX)607yzzz/aaa



EX(XX)608yzzz/aaa



IECEX Certificate of Conformity

INTERNATIONAL ELECTROTECHNICAL COMMISSION IEC Certification Scheme for Explosive Atmospheres

for rules and details of the IECEx Scheme visit www.iecex.com

Certificate No.:	IECEX LCIE 13.0045X	Issue No: 2	<u>Certificate history:</u>
Status:	Current	Page 1 of 4	Issue No. 2 (2017-03-27)
Date of Issue:	2017-03-27		Issue No. 1 (2015-11-09)
			Issue No. 0 (2013-08-20)
Applicant:	PCB Piezotronics Inc. 3425 Walden Avenue Depew, New York 14043 United States of America		
Equipment:	Vibration Sensors - Type: EX(XX)602yzzz/aaa, EX(XX)603yzzz/aaa, EX(XX)606yzzz/aaa, EX(XX)607yzzz/aaa, EX(XX)608yzzz/aaa		
Optional accessory:			
Type of Protection:	Ex ia, Ex nA		
Marking:	Ex ia IIC T4 Ga Ex nA IIC T4 Gc (Refer to attachment for full marking)		

Approved for issue on behalf of the IECEx
Certification Body:

Julien GAUTHIER

Position:

Certification Officer

Signature:
(for printed version)

Date:

1. This certificate and schedule may only be reproduced in full.
2. This certificate is not transferable and remains the property of the issuing body.
3. The Status and authenticity of this certificate may be verified by visiting the Official IECEx Website.

Certificate issued by:

Laboratoire Central des Industries Electriques (LCIE)
33 Avenue du General Leclerc
FR-92260 Fontenay-aux-Roses
France





IECEX Certificate of Conformity

Certificate No: IECEX LCIE 13.0045X

Issue No: 2

Date of Issue: **2017-03-27**

Page 2 of 4

Manufacturer: **PCB Piezotronics Inc.**
3425 Walden Avenue
Depew, New York 14043
United States of America

Additional Manufacturing location(s):
PCB Piezotronics of North Carolina Inc.
10869 Hwy 903
Halifax, NC 27839
United States of America

This certificate is issued as verification that a sample(s), representative of production, was assessed and tested and found to comply with the IEC Standard list below and that the manufacturer's quality system, relating to the Ex products covered by this certificate, was assessed and found to comply with the IECEX Quality system requirements. This certificate is granted subject to the conditions as set out in IECEX Scheme Rules, IECEX 02 and Operational Documents as amended.

STANDARDS:

The electrical apparatus and any acceptable variations to it specified in the schedule of this certificate and the identified documents, was found to comply with the following standards:

IEC 60079-0 : 2011 Edition:6.0	Explosive atmospheres - Part 0: General requirements
IEC 60079-11 : 2011 Edition:6.0	Explosive atmospheres - Part 11: Equipment protection by intrinsic safety "i"
IEC 60079-15 : 2010 Edition:4	Explosive atmospheres - Part 15: Equipment protection by type of protection "n"

*This Certificate **does not** indicate compliance with electrical safety and performance requirements other than those expressly included in the Standards listed above.*

TEST & ASSESSMENT REPORTS:

A sample(s) of the equipment listed has successfully met the examination and test requirements as recorded in

Test Report:

FR/LCIE/ExTR13.0040/00

FR/LCIE/ExTR15.0110/00

FR/LCIE/ExTR17.0015/00

Quality Assessment Report:

NL/DEK/QAR14.0004/02



IECEx Certificate of Conformity

Certificate No: IECEx LCIE 13.0045X

Issue No: 2

Date of Issue: 2017-03-27

Page 3 of 4

Schedule

EQUIPMENT:

Equipment and systems covered by this certificate are as follows:

The EX(XX)602yzzz/aaa, EX(XX)603yzzz/aaa, EX(XX)606yzzz/aaa, EX(XX)607yzzz/aaa and EX(XX)608yzzz/aaa piezoelectric vibration sensors utilize a quartz crystal to convert a mechanical vibration measurement into an electric signal.

The sensor consists of a sealed cylindrical metal case which houses a pcb substrate board and a piezo-crystal element. The circuit is connected to a connector or an integral cable.

SPECIFIC CONDITIONS OF USE: YES as shown below:

Version Ex Ia:

- The apparatus must be only connected to a certified associated intrinsically safe equipment. This combination must be compatible regarding intrinsic safety rules (see electrical parameters).
- Operating ambient temperature: -54°C to + 121°C.
- The apparatus shall be connected according to instruction manual.
- The mounting of the apparatus into an installation must be carried out in such a way that metallic body of the sensor is reliably connected to the system earth.

Version Ex nA:

- The apparatus must be only connected to an external source with $U \leq 28V$, $I \leq 200mA$, $P \leq 1W$.

- For final installation, the user shall take all necessary precautions to maintain the minimum degree of protection IP54 of the sensor connection when connected according to the requirements of EN 60079-14 standard.

- Operating ambient temperature: -54°C to +121°C.
- The apparatus must be connected according to instruction manual.
- WARNING – DO NOT SEPARATE WHEN ENERGIZED.



IECEX Certificate of Conformity

Certificate No: IECEx LCIE 13.0045X

Issue No: 2

Date of Issue: 2017-03-27

Page 4 of 4

DETAILS OF CERTIFICATE CHANGES (for issues 1 and above):

Issue 01:

- Modification of QAR
- Addition of a manufacturing site
- Modification of the Applicant name

Issue 02:

- Addition of a new option of temperature output.
- Update of the nomenclature of the models.
- Distinction between the name of the manufacturer (PCB Piezotronics Inc.) and the name of the trademark (IMI sensors or IMI).
- Change of the low temperature ambient from -40°C to -54°C.

Annex:

LCIE 13.0045x issue02-Annex00.pdf



Annex 00 to Certificate IECEx LCIE 13.0045X issue 02



FULL EQUIPMENT DESCRIPTION

The EX(XX)602yzzz/aaa, EX603(XX)yzzz/aaa, EX(XX)606yzzz/aaa, EX607(XX)yzzz/aaa et EX(XX)608yzzz/aaa piezoelectric vibration sensors utilize a quartz crystal to convert a mechanical vibration measurement into an electric signal. The sensor consists of a sealed cylindrical metal case which houses a PCB substrate board and a piezo-crystal element. The circuit is connected to a connector or an integral cable.

Title:	Drawing No.:	Rev. Level:	Date:
Technical file "Ex ia" and "Ex nA" (IECEx)	56178	A	2016/07/01
Installation manual	41721	A	2017/01/18

MARKING

Full marking:

PCB PIEZOTRONICS INC. or IMI sensors or IMI
 Address: ...
 Type: ...
 Serial number: ...
 Year of construction: ...
 Ex ia IIC T4 Ga
 Ex nA IIC T4 Gc
 $-54^{\circ}\text{C} \leq T_{\text{amb}} \leq +121^{\circ}\text{C}$
 IECEx LCIE 13.0045X
 $U_i: \dots \text{V}, I_i: \dots \text{mA}, P_i: \dots \text{W}, C_i: \dots \text{nF}, L_i: \dots \mu\text{H}$ (completed with electrical parameters)
 WARNING – DO NOT SEPARATE WHEN ENERGIZED.

Reduced marking:

PCB Piezotronic Inc. or IMI Sensors or IMI
 Type: ...
 Serial number: ...
 Year of construction: ...
 Ex ia IIC T4 Ga
 Ex nA IIC T4 Gc
 $T_a = 121^{\circ}\text{C}$
 IECEx LCIE 13.0045X

RANGE DETAILS

Models are electrically identical, but mechanically different :
 EX(XX)602yzzz/aaa, EX(XX)607yzzz/aaa and EX(XX)606yzzz/aaa: Sensor with side exit connector or integral cable,
 EX(XX)603yzzz/aaa Sensor with top exit connector or integral cable,
 EX(XX)608yzzz/aaa Sensor with top exit integral cable.

Symbol	Detail	
XX	M	Metric mounting hardware and cable
	TO	Temperature Output Sensor
y	One letter A to Z	
zzz	Two or three numbers 00 to 999	
aaa	Cable length and/or connector type	



Annex 00 to Certificate IECEx LCIE 13.0045X issue 02



RATINGS

Version "ia":

Models equipped with	Intrinsic safety parameters
Connector	$U_i : 28V, I_i : 200mA, P_i : 1W, C_i : 16.2nF, L_i : 0\mu H$
Armor jacketed cable	$U_i : 28V, I_i : 200mA, P_i : 1W, C_i : 16.2nF, L_i : 305\mu H^*$
Integral cable	$U_i : 28V, I_i : 200mA, P_i : 1W, C_i : 77.2nF, L_i : 305\mu H^*$

* cable length max 305m (1000ft)

Version "nA":

$U \leq 28V, I \leq 200mA, P \leq 1W$

ROUTINE TESTS

Version "ia": None.

Version "nA": Each apparatus shall be submitted to a dielectric strength test under 600 Volts during 100ms according to clause 23.2.1 of IEC 60079-15 standard.



IECEX Certificate of Conformity

INTERNATIONAL ELECTROTECHNICAL COMMISSION IEC Certification Scheme for Explosive Atmospheres

for rules and details of the IECEx Scheme visit www.iecex.com

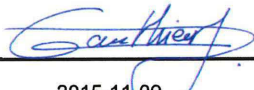
Certificate No.:	IECEX LCIE 13.0045X	issue No.:1	Certificate history: Issue No. 1 (2015-11-9) Issue No. 0 (2013-8-20)
Status:	Current		
Date of Issue:	2015-11-09	Page 1 of 4	
Applicant:	IMI Sensor, a PCB Piezotronics Div. 3425 Walden Avenue Depew, New York United States of America		
Electrical Apparatus: Optional accessory:	Vibration Sensors Type : EX602Dxx, EX603Cxx, EX607Axx, EX608Axx, EX606Bxx		
Type of Protection:	Ex ia, Ex nA		
Marking:	IMI Sensors Address : Type : EX602Dxx, EX603Cxx, EX606Bxx, EX607Axx, EX608Axx (1) Serial number : ... Year of construction : ... Ex ia IIC T4 Ga or Ex nA IIC T4 Gc IECEX LCIE 13.0045 X -40°C ≤ Ta ≤ +121°C Version "ia" only : Ui = ... V, li = ... mA, Pi = ...W, Ci = ...nF, Li = ...µH (1) (1) completed according to the model		
Approved for issue on behalf of the IECEx Certification Body:	Julien GAUTHIER		
Position:	Certification Officer		
Signature: (for printed version)			
Date:	2015-11-09		

1. This certificate and schedule may only be reproduced in full.
2. This certificate is not transferable and remains the property of the issuing body.
3. The Status and authenticity of this certificate may be verified by visiting the [Official IECEx Website](http://www.iecex.com).

Certificate issued by:
Laboratoire Central des Industries Electriques (LCIE)
33 Avenue du General Leclerc
FR-92260 Fontenay-aux-Roses
France

Documents relative to LCIE certification activities (Certificates, QARs, ExTRs) can be registered under the references "LCI" or "LCIE".



L C I E



IECEx Certificate of Conformity

Certificate No.: IECEx LCIE 13.0045X

Date of Issue: 2015-11-09

Issue No.: 1

Page 2 of 4

Manufacturer: **PCB Piezotronics**
3425 Walden Avenue
Depew, New York
United States of America

Additional Manufacturing location
(s):

**PCB Piezotronics of
North Carolina Inc.**
10869 Hwy 903
Halifax, NC 27839
United States of America

This certificate is issued as verification that a sample(s), representative of production, was assessed and tested and found to comply with the IEC Standard list below and that the manufacturer's quality system, relating to the Ex products covered by this certificate, was assessed and found to comply with the IECEx Quality system requirements. This certificate is granted subject to the conditions as set out in IECEx Scheme Rules, IECEx 02 and Operational Documents as amended.

STANDARDS:

The electrical apparatus and any acceptable variations to it specified in the schedule of this certificate and the identified documents, was found to comply with the following standards:

IEC 60079-0 : 2011 Edition: 6.0	Explosive atmospheres - Part 0: General requirements
IEC 60079-11 : 2011 Edition: 6.0	Explosive atmospheres - Part 11: Equipment protection by intrinsic safety "I"
IEC 60079-15 : 2010 Edition: 4	Explosive atmospheres - Part 15: Equipment protection by type of protection "n"

*This Certificate **does not** indicate compliance with electrical safety and performance requirements other than those expressly included in the Standards listed above.*

TEST & ASSESSMENT REPORTS:

A sample(s) of the equipment listed has successfully met the examination and test requirements as recorded in

Test Report:

FR/LCIE/ExTR13.0040/00

FR/LCIE/ExTR15.0110/00

Quality Assessment Report:

NL/DEK/QAR14.0004/01



IECEx Certificate of Conformity

Certificate No.: IECEx LCIE 13.0045X

Date of Issue: 2015-11-09

Issue No.: 1

Page 3 of 4

Schedule

EQUIPMENT:

Equipment and systems covered by this certificate are as follows:

The model EX602, EX603, EX606, EX607 and EX608 series piezoelectric vibration sensors utilize a quartz crystal to convert a mechanical vibration measurement into an electric signal. The sensor consists of a sealed cylindrical metal case (304SST), which houses a pcb substrate board and a piezo crystal element. The circuitry is connected to a two-pin "military" style connector at the end of the metal case. The EX603 and EX608 models have top exit connectors, while the EX602, EX606 and EX607 series have side exit connection facilities. The models with suffixes "0x" utilize a 2-conductor military type mating connector. Models with suffixes "1x" and "6x" are provided with an integral gland/boot and up to 305m of cable for field wire connections. The models with suffix "1x" differ from the models with suffix "6x" in that the integral cable for the models with suffix "6x" is an armored type cable. All models utilize the same electronics and piezoelectric crystal assemblies.

Models concerned :

EX602D01, EX603C01, EX606B01, EX607A01, EX602D11, EX603C11, EX606B11, EX607A11, EX608A11, EX602D61, EX603C61, EX606B61, EX607A61

CONDITIONS OF CERTIFICATION: YES as shown below:

The apparatus must be only connected to a certified associated intrinsically safe equipment and this combination must be compatible as regard intrinsic safety rules.

Operating ambient temperature : $-40^{\circ}\text{C} \leq T_a \leq +121^{\circ}\text{C}$

Electrical parameters :

All models : $U_i = 28\text{V}$, $I_i = 200\text{mA}$, $P_i = 1\text{W}$

EX60xx01 models : $C_i = 16,2\text{nF}$, $L_i = 0$

EX60xx11 models : $C_i = 77,2\text{nF}$, $L_i = 305\mu\text{F}$

EX60xx61 models : $C_i = 16,2\text{nF}$, $L_i = 305\mu\text{F}$



IECEx Certificate of Conformity

Certificate No.: IECEx LCIE 13.0045X

Date of Issue: 2015-11-09

Issue No.: 1

Page 4 of 4

DETAILS OF CERTIFICATE CHANGES (for issues 1 and above):

Issue 01 :

Modification of QAR

Addition of a manufacturing site

Modification of the Applicant name

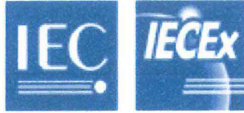

IECEx Certificate of Conformity

INTERNATIONAL ELECTROTECHNICAL COMMISSION
IEC Certification Scheme for Explosive Atmospheres
for rules and details of the IECEx Scheme visit www.iecex.com

Certificate No.: issue No.: Certificate history:

Status:

Date of Issue: **2013-08-20** Page 1 of 3

Applicant: **IMI Sensors**
A PCB Piezoelectric Div.
3425 Walden Avenue
Depew, New York
United States of America

Electrical Apparatus: **vibration sensors**
Optional accessory:

Type of Protection: **ia and nA**

Marking: IMI Sensors Address :
Type : EX602Dxx, EX603Cxx, EX606Bxx, EX607Axx, EX608Axx (1)
Serial number : ... Year of construction : ...
Ex ia IIC T4 Ga Ex nA IIC T4 Gc
IECEx LCIE 13.0045 X
-40°C ≤ Ta ≤ +121°C
Version "ia" only : Ui = ... V, li = ... mA, Pi = ...W, Ci = ...nF, Li = ...µH (1)
(1)completed according to the model

Approved for issue on behalf of the IECEx Certification Body: Jean Lanzo

Position: Certification Officer

Signature: (for printed version)

Date: 20 AOUT 2013

- 1. This certificate and schedule may only be reproduced in full.
- 2. This certificate is not transferable and remains the property of the issuing body.
- 3. The Status and authenticity of this certificate may be verified by visiting the [Official IECEx Website](http://www.iecex.com).

Certificate issued by:
Laboratoire Central des Industries Electriques (LCIE)
33 Avenue du General Leclerc
FR-92260 Fontenay-aux-Roses
France
Documents relative to LCIE certification activities (Certificates, QARs, ExTRs) can be registered under the references "LCI" or "LCIE".



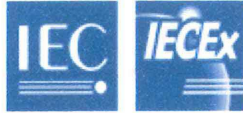

IECEX Certificate of Conformity

Certificate No.: IECEX LCIE 13.0045X

Date of Issue: 2013-08-20

Issue No.: 0

Page 2 of 3

Manufacturer: **IMI Sensors**
A PCB Piezoelectric Div.
3425 Walden Avenue
Depew, New York
United States of America

Additional Manufacturing location
(s):

This certificate is issued as verification that a sample(s), representative of production, was assessed and tested and found to comply with the IEC Standard list below and that the manufacturer's quality system, relating to the Ex products covered by this certificate, was assessed and found to comply with the IECEX Quality system requirements. This certificate is granted subject to the conditions as set out in IECEX Scheme Rules, IECEX 02 and Operational Documents as amended.

STANDARDS:

The electrical apparatus and any acceptable variations to it specified in the schedule of this certificate and the identified documents, was found to comply with the following standards:

IEC 60079-0 : 2011 Edition: 6.0	Explosive atmospheres - Part 0: General requirements
IEC 60079-11 : 2011 Edition: 6.0	Explosive atmospheres - Part 11: Equipment protection by intrinsic safety "i"
IEC 60079-15 : 2010 Edition: 4	Explosive atmospheres - Part 15: Equipment protection by type of protection "n"

*This Certificate **does not** indicate compliance with electrical safety and performance requirements other than those expressly included in the Standards listed above.*

TEST & ASSESSMENT REPORTS:

A sample(s) of the equipment listed has successfully met the examination and test requirements as recorded in

Test Report:
[FR/LCIE/ExTR13.0040/00](#)

Quality Assessment Report:
[CA/CSA/QAR09.0018/02](#)

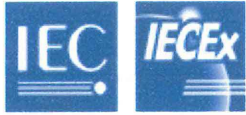

IECEx Certificate of Conformity

Certificate No.: IECEx LCIE 13.0045X

Date of Issue: 2013-08-20

Issue No.: 0

Page 3 of 3

Schedule

EQUIPMENT:

Equipment and systems covered by this certificate are as follows:

The model EX602, EX603, EX606, EX607 and EX608 series piezoelectric vibration sensors utilize a quartz crystal to convert a mechanical vibration measurement into an electric signal. The sensor consists of a sealed cylindrical metal case (304SST), which houses a pcb substrate board and a piezo crystal element. The circuitry is connected to a two-pin "military" style connector at the end of the metal case. The EX603 and EX608 models have top exit connectors, while the EX602, EX606 and EX807 series have side exit connection facilities. The models with suffixes "0x" utilize a 2-conductor military type mating connector. Models with suffixes "1x" and "6x" are provided with an integral gland/boot and up to 305m of cable for field wire connections. The models with suffix "1x" differ from the models with suffix "6x" in that the integral cable for the models with suffix "6x" is an armored type cable. All models utilize the same electronics and piezo-electric crystal assemblies.

Models concerned :

EX602D01, EX603C01, EX606B01, EX607A01, EX602D11, EX603C11, EX606B11, EX607A11, EX608A11, EX602D61, EX603C61, EX606B61, EX607A61

CONDITIONS OF CERTIFICATION: YES as shown below:

The apparatus must be only connected to a certified associated intrinsically safe equipment and this combination must be compatible as regard intrinsic safety rules.

Operating ambient temperature : $-40^{\circ}\text{C} \leq T_a \leq +121^{\circ}\text{C}$

Electrical parameters :

All models : $U_i = 28\text{V}$, $I_i = 200\text{mA}$, $P_i = 1\text{W}$

EX60xx01 models : $C_i = 16,2\text{nF}$, $L_i = 0$

EX60xx11 models : $C_i = 77,2\text{nF}$, $L_i = 305\mu\text{F}$

EX60xx61 models : $C_i = 16,2\text{nF}$, $L_i = 305\mu\text{F}$

1 Version : 04

LCIE 06 ATEX 6033 X

Issue : 04

- | | |
|--|--|
| <p>2 Directive 2014/34/UE
Appareil ou Système de Protection destiné à être utilisé en Atmosphères Explosibles</p> <p>3 Produit :
Capteurs de vibration</p> <p>4 Fabricant :</p> <p>5 Adresse :</p> <p>6 Ce produit et ses variantes éventuelles acceptées sont décrits dans l'annexe de la présente attestation et dans les documents descriptifs cités en référence.</p> <p>7 Le LCIE, Organisme Notifié sous la référence 0081 conformément à l'article 17 de la directive 2014/34/UE du Parlement européen et du Conseil du 26 février 2014, certifie que ce produit est conforme aux Exigences Essentielles de Sécurité et de Santé pour la conception et la construction de produits destinés à être utilisés en atmosphères explosibles, données dans l'annexe II de la Directive. Accréditation Cofrac Certification de Produits et Services, n°5-0014. Portée disponible sur www.cofrac.fr.</p> <p>Le résultats des vérifications et essais figurent dans le(s) rapport(s) confidentiel(s) N° :
60042416/542372, 95367-590025-02, 120351-640382, 141243-684381 et/and 162291-739114-1</p> <p>8 Le respect des Exigences Essentielles de Sécurité et de Santé est assuré par la conformité à :</p> <p>9 Le signe « X » lorsqu'il est placé à la suite du numéro de l'attestation, indique que cet appareil est soumis aux conditions particulières d'utilisation, mentionnées dans l'annexe de cette attestation.</p> <p>10 Cette Attestation d'Examen UE de Type concerne uniquement la conception et la construction du produit spécifié. Des exigences supplémentaires de la directive sont applicables pour la fabrication et la fourniture du produit. Ces dernières ne sont pas couvertes par la présente attestation.</p> <p>11 Le marquage du produit est mentionné dans l'annexe de cette attestation.</p> | <p>Directive 2014/34/EU
Equipment or Protective System Intended for use in Potentially Explosive Atmospheres</p> <p>Product :
Vibration sensors</p> <p>Manufacturer :
IMI Sensors, a PCB Piezotronics Division</p> <p>Address :
3425 Walden Avenue
Depew, New York 14043
USA</p> <p>This product and any acceptable variations thereto are specified in the schedule to this certificate and the documents therein referred to.</p> <p>LCIE, Notified Body number 0081 in accordance with article 17 of the Directive 2014/34/EU of the European Parliament and the Council of 26 February 2014 certifies that product has been found to comply with the Essential Health and Safety Requirements relating to the design and construction of products intended for use in potentially explosive atmospheres, given in Annex II to the Directive. Accréditation Cofrac Certification de Produits et Services, n°5-0014. Portée disponible sur www.cofrac.fr.</p> <p>The examination and test results are recorded in confidential report(s) N°:
60042416/542372, 95367-590025-02, 120351-640382, 141243-684381 et/and 162291-739114-1</p> <p>Compliance with the Essential Health and Safety Requirements has been assured by compliance with :</p> <p>If the sign "X" is placed after the certificate number, it indicates that the product is subject to the Specific Conditions of Use specified in the schedule to this certificate.</p> <p>This EU Type Examination Certificate relates only to the design and construction of the specified product. Further requirements of the Directive apply to the manufacturing process and supply of this product. These are not covered by this certificate.</p> <p>The marking of the product is specified in the schedule to this certificate.</p> |
|--|--|

Fontenay-aux-Roses, le 9 septembre 2022

Responsable de Certification

Certification Officer

Julien Gauthier



Seul le texte en français peut engager la responsabilité du LCIE. Ce document ne peut être reproduit ou diffusé sans son intégralité, sans aucune modification. Il est établi en accord avec le référentiel de certification ATEX du LCIE. The LCIE's liability applies only on the French text. This document may only be reproduced in its entirety and without any change. It is issued in accordance with LCIE's [ATEX Certification Rules](#).
CERT-ATEX-FORM 04 Rev. 05

Rev.A

Page 1 / 4

12 DESCRIPTION DU PRODUIT

Les capteurs de vibration piézoélectriques utilisent un cristal de quartz pour convertir une mesure de vibration mécanique en un signal électrique.
Le capteur se compose d'un boîtier métallique cylindrique scellé qui abrite une carte de substrat PCB et un élément piézo-cristal. Le circuit est relié à un connecteur ou à un câble intégré.

DESCRIPTION OF PRODUCT

The piezoelectric vibration sensors utilize a quartz crystal to convert a mechanical vibration measurement into an electric signal.
The sensor consists of a sealed cylindrical metal case which houses a PCB substrate board and a piezo-crystal element. The circuit is connected to a connector or an integral cable.

DETAIL DE LA GAMME

Les modèles sont électriquement identiques, mais mécaniquement différents :

RANGE DETAILS

Models are electrically identical, but mechanically different:

EX(XX)602yzzz/aaa EX(XX)607yzzz/aaa EX(XX)606yzzz/aaa	Capteur avec connecteur ou câble intégré de sortie latérale <i>Sensor with side exit connector or integral cable</i>
EX(XX)603yzzz/aaa	Capteur avec connecteur ou câble intégré de sortie dirigée vers le haut <i>Sensor with top exit connector or integral cable</i>
EX(XX)608yzzz/aaa	Capteur avec câble intégré de sortie dirigée vers le haut <i>Sensor with top exit integral cable</i>

Symbole <i>Symbol</i>	Détail <i>Detail</i>
XX	M: Option de fixation de montage métrique <i>Metric mounting fastener option</i>
	TO: Option de capteur de température de sortie <i>Temperature Output Sensor option</i>
y	Une lettre de A à Z pour le niveau de révision du modèle <i>One letter A to Z for model revision level</i>
z z z	Commande spéciale <i>Special order</i>
	Gamme de sensibilité (par exemple : 1 = 100mV/g) <i>Sensitivity range (for example: 1 = 100mV/g)</i>
	0 = Connecteur militaire 2-pin <i>2-pin Military Connector</i>
	1 = Câble gainé en polyuréthane intégré <i>Integral polyurethane jacketed cable</i>
	2 = Câble gainé en FEP intégré <i>Integral FEP jacketed cable</i>
	3 = Connecteur militaire à baïonnette <i>Bayonet Military Connector</i>
	4 = 10-32 sortie dirigée vers le haut <i>10-32 top exit</i>
	5 = 10-32 sortie latérale <i>10-32 side exit</i>
	6 = Câble gainé blindé en polyuréthane intégré <i>Integral armored polyurethane jacketed cable</i>
	7 = Bornier de raccordement <i>Terminal block</i>
8 = Mini connecteur militaire <i>Mini Military Connector</i>	
9 = A définir <i>To be determined</i>	
aaa	Longueur de câble (par exemple : 010 = 10 feet) <i>Cable length (for example: 010 = 10 feet)</i>

Seul le texte en français peut engager la responsabilité du LCIE. Ce document ne peut être reproduit que dans son intégralité, sans aucune modification. Il est établi en accord avec le référentiel de certification ATEX du LCIE. *The LCIE's liability applies only on the French text. This document may only be reproduced in its entirety and without any change. It is issued in accordance with LCIE's ATEX Certification Rules.* Rev.A
CERT-ATEX-FORM 04 Rev. 05 Page 2 / 4

CARACTERISTIQUES

Modèles équipés avec <i>Models equipped with</i>	Paramètres de sécurité intrinsèque <i>Intrinsic safety parameters</i>
Connecteur <i>Connector</i>	$U_i : 28V, I_i : 120mA, P_i : 0.84W, C_i : 46.5nF, L_i : 0\mu H$
Câble avec armure et câble intégré <i>Integral armored cable and Integral jacketed cable</i>	$U_i : 28V, I_i : 120mA, P_i : 0.84W, C_i : 77nF, L_i : 152.5\mu H^*$

* longueur maximale de câble / *cable length max* 152.5m (500ft)

RATINGS

MARQUAGE

Le marquage du produit doit comprendre :

Marquage complet :

PCB Piezotronics Inc. ou IMI Sensors ou IMI

Adresse : ...

Type : ...

N° de fabrication : ...

Année de fabrication : ...

⊕ II 1 G

Ex ia IIC T4 Ga

LCIE 06 ATEX 6033 X

$-54^{\circ}C \leq T_{amb} \leq +121^{\circ}C$

$U_i : \dots V, I_i : \dots mA, P_i : \dots W, C_i : \dots nF, L_i : \dots \mu F$ (complété suivant le modèle)

Marquage réduit :

PCB Piezotronics Inc. ou IMI Sensors ou IMI

Type : ...

N° de fabrication : ...

Année de fabrication : ...

⊕ II 1 G

Ex ia IIC T4 Ga, $T_a = 121^{\circ}C$

LCIE 06 ATEX 6033 X

L'appareil doit également comporter le marquage normalement prévu par les normes de construction qui le concernent sous la responsabilité du fabricant.

MARKING

The marking of the product shall include the following :

Full marking:

PCB Piezotronics Inc. or IMI Sensors or IMI

Address: ...

Type: ...

Serial number: ...

Year of construction: ...

⊕ II 1 G

Ex ia IIC T4 Ga

LCIE 06 ATEX 6033 X

$-54^{\circ}C \leq T_{amb} \leq +121^{\circ}C$

$U_i : \dots V, I_i : \dots mA, P_i : \dots W, C_i : \dots nF, L_i : \dots \mu F$ (completed following the model)

Reduced marking:

PCB Piezotronic Inc. or IMI Sensors or IMI

Type: ...

Serial number: ...

Year of construction: ...

⊕ II 1 G

Ex ia IIC T4 Ga, $T_a = 121^{\circ}C$

LCIE 06 ATEX 6033 X

The equipment shall also bear the usual marking required by the product standards applying to such equipment under the manufacturer responsibility.

13 CONDITIONS PARTICULIERES D'UTILISATION

- a. Les matériels de sécurité intrinsèque ne doivent être raccordés qu'à des matériels associés de sécurité intrinsèque certifiés pour l'usage considéré. Cette association doit répondre aux exigences de la norme EN 60079-25.
- b. Température ambiante de fonctionnement : $-54^{\circ}C$ à $+121^{\circ}C$.
- c. L'appareil doit être raccordé conformément au manuel d'instruction.
- d. Le montage du produit dans une installation doit être effectué de telle sorte que le corps métallique du capteur soit relié de manière fiable à la terre du système.

SPECIFIC CONDITIONS OF USE

The intrinsically safe apparatus shall only be connected to associated intrinsically safe apparatus certified for the intended use. This association shall comply with the requirements of the EN 60079-25 standard.

Operating ambient temperature: $-54^{\circ}C$ to $+121^{\circ}C$.

The apparatus must be connected according to instruction manual.

The mounting of the apparatus into an installation must be carried out in such a way that metallic body of the sensor is reliably connected to the system earth.

14 EXIGENCES ESSENTIELLES DE SANTE ET DE SECURITE

Couvertes par les normes listées au point 8.

ESSENTIAL HEALTH AND SAFETY REQUIREMENTS

Covered by standards listed at 8.

Seul le texte en français peut engager la responsabilité du LCIE. Ce document ne peut être reproduit que dans son intégralité, sans aucune modification. Il est établi en accord avec le référentiel de certification ATEX du LCIE. *The LCIE's liability applies only on the French text. This document may only be reproduced in its entirety and without any change. It is issued in accordance with LCIE's ATEX Certification Rules.* Rev.A
 CERT-ATEX-FORM 04 Rev. 05 Page 3 / 4

15 DOCUMENTS DESCRIPTIFS

DESCRIPTIVE DOCUMENTS

N°	Description	Reference	Rev.	Date	Page(s)
1.	Dossier technique Ex ia et Ex nA <i>Technical File Ex ia and Ex nA</i>	33699	D	2020/02/11	41
2.	Instructions d'utilisation <i>Instruction for use</i>	41721	---	---	---

16 INFORMATIONS COMPLEMENTAIRES

ADDITIONAL INFORMATION

Essais individuels

Néant.

Conditions de certification

Les détenteurs d'attestations d'examen UE de type doivent également satisfaire les exigences de contrôle de production telles que définies à l'article 13 de la Directive 2014/34/UE.

En accord avec l'Article 41 de la Directive 2014/34/UE, les attestations d'examen CE de type mentionnant la Directive 94/9/CE émises avant la date d'application de la Directive 2014/34/UE (20 avril 2016) peuvent être considérées comme émises en accord avec la Directive 2014/34/UE. Les nouvelles versions de ces attestations peuvent conserver le numéro de l'attestation d'origine émise avant le 20 avril 2016.

Routine tests

None.

Conditions of certification

Holders of EU type examination certificates are also required to comply with the production control requirements defined in article 13 of Directive 2014/34/EU.

In accordance with Article 41 of Directive 2014/34/EU, EC-Type Examination Certificates referring to Directive 94/9/EC that were in existence prior to the date of application of Directive 2014/34/EU (20 April 2016) may be referenced as if they were issued in accordance with Directive 2014/34/EU. New issues of such certificates may continue to bear the original certificate number issued prior to 20 April 2016.

17 DETAILS DES MODIFICATIONS DE L'ATTESTATION

DETAILS OF CERTIFICATE CHANGES

Version 00 : Evaluation initiale selon les normes EN 50014:1997 + amendement 1 à 2 et EN 50020:2002.

Issue 00: Initial assessment according to EN 50014:1997 + amendments 1 to 2 and EN 50020:2002 standards.

Version 01 : Mise à jour normative selon les normes EN 60079-0:2006 et EN 60079-11:2007.

Issue 01: Normative update according to EN 60079-0:2006 and EN 60079-11:2007 standards.

Version 02 : - Mise à jour normative selon les normes EN 60079-0:2012 et EN 60079-11:2012.
- Mise à jour des documents techniques.

Issue 02: - Normative update according to EN 60079-0:2012 and EN 60079-11:2012 standards.
- Update of technical documents.

Version 03 : - Ajout d'une nouvelle option de sortie de température.
- Mise à jour de la nomenclature des modèles.
- Distinction entre le nom du fabricant (PCB Piezotronics Inc) et le nom de la marque commerciale (IMI sensors ou IMI).
- Mise à jour normative selon la norme EN 60079-0:2012+A11:2013.
- Changement de température ambiante basse de -40°C à -54°C.

Issue 03: - Addition of a new option of temperature output.
- Update of the nomenclature of the models.
- Distinction between the name of the manufacturer (PCB Piezotronics Inc) and the name of the trademark (IMI sensors or IMI).
- Normative update according to EN 60079-0:2012 + A11:2013 standard.
- Change of the low temperature ambient from -40°C to -54°C.

Version 04 : - Ajout de trois capacités.
- Réduction de la longueur du câble de connexion.
- Mise à jour des paramètres électriques de sécurité intrinsèque.

Issue 04: - Addition of three capacitors.
- Reduction of the connection cable length.
- Update of the intrinsic safe electrical parameters.

Version 04 : Réémission sous accréditation. Pas d'évaluation complémentaire.

Issue 04: New issue under accreditation. No additional assessment.



ATTESTATION D'EXAMEN UE DE TYPE EU TYPE EXAMINATION CERTIFICATE



1 Version : 03

LCIE 06 ATEX 6033 X

Issue : 03

- | | |
|--|---|
| <p>2 Appareil ou Système de Protection destiné à être utilisé en Atmosphères Explosibles</p> <p>3 Produit :
Capteurs de vibration</p> <p>4 Fabricant :</p> <p>A Adresse :</p> <p>6 Ce produit et ses variantes éventuelles acceptées sont décrits dans l'annexe de la présente attestation et dans les documents descriptifs cités en référence.</p> <p>7 Le LCIE, Organisme Notifié sous la référence 0081 conformément à l'article 17 de la directive 2014/34/UE du Parlement européen et du Conseil du 26 février 2014, certifie que ce produit est conforme aux Exigences Essentielles de Sécurité et de Santé pour la conception et la construction de produits destinés à être utilisés en atmosphères explosibles, données dans l'annexe II de la Directive.
Les résultats des vérifications et essais figurent dans le(s) rapport(s) confidentiel(s) N° :</p> <p>8 Le respect des Exigences Essentielles de Sécurité et de Santé est assuré par la conformité à :</p> <p>9 Le signe « X » lorsqu'il est placé à la suite du numéro de l'attestation, indique que cet appareil est soumis aux conditions particulières d'utilisation, mentionnées dans l'annexe de cette attestation.</p> <p>10 Cette Attestation d'Examen UE de Type concerne uniquement la conception et la construction du produit spécifié.
Des exigences supplémentaires de la directive sont applicables pour la fabrication et la fourniture du produit. Ces dernières ne sont pas couvertes par la présente attestation.</p> <p>11 Le marquage du produit est mentionné dans l'annexe de cette attestation.</p> | <p>Equipment or Protective System Intended for use in Potentially Explosive Atmospheres</p> <p>Product :
Vibration sensors</p> <p>Manufacturer :
PCB Piezotronics Inc.</p> <p>Address :
3425 Walden Avenue
Depew, New York 14043
USA</p> <p>This product any acceptable variation thereto is specified in the schedule to this certificate and the documents therein referred to.</p> <p>LCIE, Notified Body number 0081 in accordance with article 17 of the Directive 2014/34/EU of the European Parliament and the Council of 26 February 2014 certifies that product has been found to comply with the Essential Health and Safety Requirements relating to the design and construction of products intended for use in potentially explosive atmospheres, given in Annex II to the Directive.
The examination and test results are recorded in confidential report(s) N°:
60042416/542372, 95367-590025-02, 120351-640382, 141243-684381</p> <p>Compliance with the Essential Health and Safety Requirements has been assured by compliance with :
EN 60079-0:2012 + A11:2013, EN 60079-11:2012</p> <p>If the sign "X" is placed after the certificate number, it indicates that the product is subject to the Specific Conditions of Use specified in the schedule to this certificate.</p> <p>This EU Type Examination Certificate relates only to the design and construction of the specified product.
Further requirements of the Directive apply to the manufacturing process and supply of this product. These are not covered by this certificate.</p> <p>The marking of the product is specified in the schedule to this certificate.</p> |
|--|---|

Fontenay-aux-Roses, le 27 mars 2017

Responsable de Certification

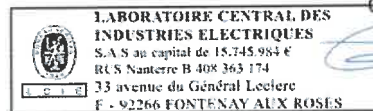

Certification Officer
Julien Gauthier

Seul le texte en français peut engager la responsabilité du LCIE. Ce document ne peut être reproduit que dans son intégralité, sans aucune modification. Il est établi en accord avec le référentiel de certification ATEX du LCIE. The LCIE's liability applies only on the French text. This document may only be reproduced in its entirety and without any change. It is issued in accordance with LCIE's ATEX Certification Rules.
CERT-ATEX-FORM 04 Rev. 02

Page 1 of 4

LCIE

Laboratoire Central des Industries Electriques

Une société de Bureau Veritas

33 Avenue du Général Leclerc

92260 Fontenay-aux-Roses

FRANCE

WWW.LCIE.FR

12 DESCRIPTION DU PRODUIT

Les capteurs de vibration piézoélectriques EX(XX)602yzzz/aaa, EX(XX)603yzzz/aaa, EX(XX)606yzzz/aaa, EX(XX)607yzzz/aaa et EX(XX)608yzzz/aaa utilisent un cristal de quartz pour convertir une mesure de vibration mécanique en un signal électrique.

Le capteur se compose d'un boîtier métallique cylindrique scellé qui abrite une carte de substrat PCB et un élément piézo-cristal. Le circuit est relié à un connecteur ou à un câble intégré.

Paramètres électriques :

Modèles équipés avec <i>Models equipped with</i>	Paramètres de sécurité intrinsèque <i>Intrinsic safety parameters</i>
Connecteur / <i>Connector</i>	$U_i : 28V, I_i : 200mA, P_i : 1W, C_i : 16.2nF, L_i : 0\mu H$
Câble avec amure / <i>Armor jacketed cable</i>	$U_i : 28V, I_i : 200mA, P_i : 1W, C_i : 16.2nF, L_i : 305\mu H^*$
Câble intégré / <i>Integral cable</i>	$U_i : 28V, I_i : 200mA, P_i : 1W, C_i : 77.2nF, L_i : 305\mu H^*$

* longueur maximale de câble / *cable length max 305m (1000ft)*

DETAIL DE LA GAMME

Les modèles sont électriquement identiques, mais mécaniquement différents:

EX(XX)602yzzz/aaa, EX(XX)607yzzz/aaa et EX(XX)606yzzz/aaa : Capteur avec connecteur ou câble intégré de sortie latérale,
 EX(XX)603yzzz/aaa: Capteur avec connecteur ou câble intégré de sortie dirigée vers le haut,
 EX(XX)608yzzz/aaa: Capteur avec câble intégré de sortie dirigée vers le haut.

DESCRIPTION OF PRODUCT

The EX(XX)602yzzz/aaa, EX(XX)603yzzz/aaa, EX(XX)606yzzz/aaa, EX(XX)607yzzz/aaa and EX(XX)608yzzz/aaa piezoelectric vibration sensors utilize a quartz crystal to convert a mechanical vibration measurement into an electric signal.

The sensor consists of a sealed cylindrical metal case which houses a PCB substrate board and a piezo-crystal element. The circuit is connected to a connector or an integral cable.

Electrical parameters:

RANGE DETAILS

Models are electrically identical, but mechanically different:

EX(XX)602yzzz/aaa, EX(XX)607yzzz/aaa and EX(XX)606yzzz/aaa: Sensor with side exit connector or integral cable,
 EX(XX)603yzzz/aaa: Sensor with top exit connector or integral cable,
 EX(XX)608yzzz/aaa: Sensor with top exit integral cable.

Symbole / <i>Symbol</i>		Détail / <i>Detail</i>
XX	M	Câble et matériel de montage métrique <i>Metric mounting hardware and cable</i>
	TO	Capteur de température de sortie <i>Temperature Output Sensor</i>
y		Une lettre de A à Z / <i>One letter A to Z</i>
zzz		Deux ou trois chiffres de 00 à 999 <i>Two or three numbers 00 to 999</i>
aaa		Longueur de câble et/ou type de connecteur <i>Cable length and/or connector type</i>

MARQUAGE

Le marquage du produit doit comprendre :

Marquage complet :

PCB Piezotronics Inc. ou IMI Sensors ou IMI
 Adresse : ...
 Type : ...
 N° de fabrication : ...
 Année de fabrication : ...
 Ⓢ II 1 G
 Ex ia IIC T4 Ga
 LCIE 06 ATEX 6033 X
 $-54^{\circ}C \leq T_{amb} \leq +121^{\circ}C$
 $U_i : \dots V, I_i : \dots mA, P_i : \dots W, C_i : \dots nF, L_i : \dots \mu F$ (complété suivant le modèle)

MARKING

The marking of the product shall include the following :

Full marking:

PCB Piezotronics Inc. or IMI Sensors or IMI
 Address: ...
 Type: ...
 Serial number: ...
 Year of construction: ...
 Ⓢ II 1 G
 Ex ia IIC T4 Ga
 LCIE 06 ATEX 6033 X
 $-54^{\circ}C \leq T_{amb} \leq +121^{\circ}C$
 $U_i : \dots V, I_i : \dots mA, P_i : \dots W, C_i : \dots nF, L_i : \dots \mu F$ (completed following the model)

Seul le texte en français peut engager la responsabilité du LCIE. Ce document ne peut être reproduit que dans son intégralité, sans aucune modification. Il est établi en accord avec le référentiel de certification ATEX du LCIE. The LCIE's liability applies only on the French text. This document may only be reproduced in its entirety and without any change. It is issued in accordance with LCIE's ATEX Certification Rules.
 CERT-ATEX-FORM 04 Rev. 02

Marquage réduit :

PCB Piezotronics Inc. ou IMI Sensors ou IMI

Type :

N° de fabrication : ...

Année de fabrication : ...

Ⓜ II 1 G

Ex ia IIC T4 Ga, T_a = 121°C

LCIE 06 ATEX 6033 X

L'appareil doit également comporter le marquage normalement prévu par les normes de construction qui le concernent sous la responsabilité du fabricant.

Reduced marking:

PCB Piezotronic Inc. or IMI Sensors or IMI

Type: ...

Serial number: ...

Year of construction: ...

Ⓜ II 1 G

Ex ia IIC T4 Ga, T_a = 121°C

LCIE 06 ATEX 6033 X

The equipment shall also bear the usual marking required by the product standards applying to such equipment under the manufacturer responsibility.

13 CONDITIONS PARTICULIERES D'UTILISATION

- a. L'appareil doit être raccordé à un appareil associé certifié de sécurité intrinsèque. Cette combinaison doit être compatible avec les règles de sécurité intrinsèque (voir les paramètres électriques au paragraphe 12).
- b. Température ambiante de fonctionnement : -54°C à +121°C.
- c. L'appareil doit être raccordé conformément au manuel d'instruction.
- d. Le montage du produit dans une installation doit être effectué de telle sorte que le corps métallique du capteur soit relié de manière fiable à la terre du système.

SPECIFIC CONDITIONS OF USE

The apparatus must be only connected to a certified associated intrinsically safe equipment. This combination must be compatible regarding intrinsic safety rules (see electrical parameters in chapter 12).

Operating ambient temperature: - 54°C to + 121°C.

The apparatus must be connected according to instruction manual.

The mounting of the apparatus into an installation must be carried out in such a way that metallic body of the sensor is reliably connected to the system earth.

14 EXIGENCES ESSENTIELLES DE SANTE ET DE SECURITE

Couvertes par les normes listées au point 8.

ESSENTIAL HEALTH AND SAFETY REQUIREMENTS

Covered by standards listed at 8.

15 DOCUMENTS DESCRIPTIFS

N°	Description	Reference	Rev.	Date	Page(s)
1.	Instruction manual	41721	A	2017/01/18	3
2.	Technical file	33699	C	2016/06/16	42

DESCRIPTIVE DOCUMENTS

16 INFORMATIONS COMPLEMENTAIRES

Essais individuels

Néant.

Conditions de certification

Les détenteurs d'attestations d'examen UE de type doivent également satisfaire les exigences de contrôle de production telles que définies à l'article 13 de la Directive 2014/34/UE.

En accord avec l'Article 41 de la Directive 2014/34/UE, les attestations d'examen CE de type mentionnant la Directive 94/9/CE émises avant la date d'application de la Directive 2014/34/UE (20 avril 2016) peuvent être considérées comme émises en accord avec la Directive 2014/34/UE. Les nouvelles versions de ces attestations peuvent conserver le numéro de l'attestation d'origine émise avant le 20 avril 2016.

ADDITIONAL INFORMATIONS

Routine tests

None.

Conditions of certification

Holders of EU type examination certificates are also required to comply with the production control requirements defined in article 13 of Directive 2014/34/EU.

In accordance with Article 41 of Directive 2014/34/EU, EC-Type Examination Certificates referring to Directive 94/9/EC that were in existence prior to the date of application of Directive 2014/34/EU (20 April 2016) may be referenced as if they were issued in accordance with Directive 2014/34/EU. New issues of such certificates may continue to bear the original certificate number issued prior to 20 April 2016.



ATTESTATION D'EXAMEN UE DE TYPE - ANNEXE

EU TYPE EXAMINATION CERTIFICATE - SCHEDULE

1 Version : 03

LCIE 06 ATEX 6033 X

Issue : 03

17 DETAILS DES MODIFICATIONS

- Version 00 : Evaluation initiale selon les normes
22/05/2006 EN 50014:1997 + amendement 1 à 2 et
EN 50020:2002.
- Version 01 : Mise à jour normative selon les normes
04/05/2010 EN 60079-0:2006 et EN 60079-11:2007.
- Version 02 : - Mise à jour normative selon les normes
20/08/2015 EN 60079-0:2012 et EN 60079-11:2012.
- Mise à jour des documents techniques.
- Version 03 : - Ajout d'une nouvelle option de sortie de
température.
- Mise à jour de la nomenclature des modèles.
- Distinction entre le nom du fabricant (PCB
Piezotronics Inc) et le nom de la marque
commerciale (IMI sensors ou IMI).
- Mise à jour normative selon la norme
EN 60079-0:2012 + A11:2013.
- Changement de température ambiante basse
de -40°C à -54°C.

DETAILS OF CHANGES

- Issue 00: Initial assessment according to EN 50014:1997
2006/05/22 + amendments 1 to 2 and EN 50020:2002
standards.
- Issue 01: Normative update according to
2010/05/04 EN 60079-0:2006 and EN 60079-11:2007
standards.
- Issue 02: - Normative update according to
2015/08/20 EN 60079-0:2012 and EN 60079-11:2012
standards.
- Update of technical documents.
- Issue 03: - Addition of a new option of temperature output.

- Update of the nomenclature of the models.
- Distinction between the name of the
manufacturer (PCB Piezotronics Inc) and the
name of the trademark (IMI sensors or IMI).
- Normative update according to
EN 60079-0:2012 + A11:2013 standard.
- Change of the low temperature ambient from
-40°C to -54°C.

Seul le texte en français peut engager la responsabilité du LCIE. Ce document ne peut être reproduit que dans son intégralité, sans aucune modification. Il est établi en accord avec le [référentiel de certification ATEX](#) du LCIE. *The LCIE's liability applies only on the French text. This document may only be reproduced in its entirety and without any change. It is issued in accordance with LCIE's [ATEX Certification Rules](#).*
CERT-ATEX-FORM 04 Rev. 02

Page 4 of 4

LCIE

Laboratoire Central des Industries Electriques
Une société de Bureau Veritas

33 Avenue du Général Leclerc
92260 Fontenay-aux-Roses
FRANCE

WWW.LCIE.FR



LCIE

1 AVENANT D'ATTESTATION D'EXAMEN CE DE TYPE

2 Appareil ou système de protection destiné à être utilisé en atmosphères explosibles (Directive 94/9/CE)

3 Numéro de l'avenant :
LCIE 06 ATEX 6033 X / 02

4 Appareil ou système de protection :
Capteurs de vibration
Type : EX602Dxx, EX603Cxx, EX606Bxx,
EX607Axx, EX608Axx

5 Demandeur : IMI Sensors
A PCB Piezoelectric Div.

15 DESCRIPTION DE L'AVENANT

Mise à jour normative suivant les normes EN 60079-0:2012 et EN 60079-11:2012.
Mise à jour des documents.

Les résultats des vérifications et essais figurent dans le rapport confidentiel N°120351-640382.

Paramètres spécifiques du ou des modes de protection concerné(s) :
Inchangés.

Le marquage doit être : Modifié comme suit :
IMI Sensors Adresse : ...
Type : EX602Dxx, EX603Cxx, EX606Bxx, EX607Axx, EX608Axx (1)
Numéro de fabrication : ... Année de fabrication : ...

⊕ II 1 G
Ex ia IIC T4 Ga
LCIE 06 ATEX 6033 X
-40°C ≤ Ta ≤ +121°C
Ui ≤ ... V, Ii ≤ ... mA, Pi ≤ ... W, Ci ≤ ... nF, Li ≤ ... μH (1)
(1) complété en fonction du modèle

16 DOCUMENTS DESCRIPTIFS

Dossier technique N°33699 rev.B du 18/04/2013.
Ce dossier comprend 10 rubriques (25 pages).

17 CONDITIONS SPECIALES POUR UNE UTILISATION SURE

Inchangées.

18 EXIGENCES ESSENTIELLES DE SECURITE ET DE SANTE

Couvertes par les normes EN 60079-0:2012 et EN 60079-11:2012.

19 VERIFICATIONS ET ESSAIS INDIVIDUELS

Inchangés.

Fontenay-aux-Roses, le **20 AOUT 2013**

1 SUPPLEMENTARY EC TYPE EXAMINATION CERTIFICATE

2 Equipment or protective system intended for use in potentially explosive atmospheres (Directive 94/9/EC)

3 Supplementary certificate number :
LCIE 06 ATEX 6033 X / 02

4 Equipment or protective system :
Vibration sensors
Type : EX602Dxx, EX603Cxx, EX606Bxx, EX607Axx, EX608Axx

5 Applicant : IMI Sensors
A PCB Piezoelectric Div.

15 DESCRIPTION OF THE SUPPLEMENTARY CERTIFICATE

Normative update according to EN60079-0:2012 and EN 60079-11:2012 standards.
Update of documents.

The examination and test results are recorded in confidential report N°120351-640382.

Specific parameters of the concerned protection mode :
Unchanged.

The marking shall be : Modified as follows :
IMI Sensors Address : ...
Type : EX602Dxx, EX603Cxx, EX606Bxx, EX607Axx, EX608Axx (1)
Serial number : ... Year of construction : ...

⊕ II 1 G
Ex ia IIC T4 Ga
LCIE 06 ATEX 6033 X
-40°C ≤ Ta ≤ +121°C
Ui ≤ ... V, Ii ≤ ... mA, Pi ≤ ... W, Ci ≤ ... nF, Li ≤ ... μH (1)
(1) completed according to the model

16 DESCRIPTIVE DOCUMENTS

Technical file N°33699 rev.B dated 2013/04/18.
This file includes 10 items (25 pages).

17 SPECIAL CONDITIONS FOR SAFE USE

Unchanged.

18 ESSENTIAL HEALTH AND SAFETY REQUIREMENTS

Covered by the standards EN 60079-0:2012 and EN 60079-11:2012.

19 ROUTINE VERIFICATIONS AND TESTS

Unchanged.

Le responsable de certification ATEX
ATEX Certification Officer



Seul le texte en français peut engager la responsabilité du LCIE. Ce document ne peut être reproduit ou diffusé sans son intégralité, sans aucune modification.
The LCIE's liability applies only on the French text. This document may only be reproduced in its entirety without any change.

Page 1 sur 1

01A-Annexe III_CE_typ_app_av - rev3 .DOC



LCIE

1 AVENANT D'ATTESTATION D'EXAMEN CE DE TYPE

2 Appareil ou système de protection destiné à être utilisé en atmosphères explosibles (Directive 94/9/CE)

3 Numéro de l'avenant : LCIE 06 ATEX 6033 X / 01

4 Appareil ou système de protection : Capteurs de vibrations
Type : EX602Dxx, EX603Cxx, EX606Bxx, EX607Axx, EX608Axx

5 Demandeur : IMI Sensors PCB Piezotronics Div.

15 DESCRIPTION DE L'AVENANT

Mise à jour normative selon les normes EN 60079-0 (2006) et EN 60079-11 (2007).

Les résultats des vérifications et essais figurent dans le rapport confidentiel N°95367-590025-02.

Paramètres spécifiques du ou des modes de protection concerné(s) : Inchangés.

Le marquage doit être : IMI Sensors
Adresse :
Type : EX 60... (1)
N° de fabrication :Année de fabrication :
II 1 G Ex ia IIC T4
LCIE 06 ATEX 6033X
T amb. : - 40°C à + 121°C
(1) complété suivant le modèle

16 DOCUMENTS DESCRIPTIFS

Dossier de certification N° 33698 rév. A du 19/04/2010. Ce dossier comprend 10 rubriques (22 pages).

17 CONDITIONS SPECIALES POUR UNE UTILISATION SURE

Inchangées.

18 EXIGENCES ESSENTIELLES DE SECURITE ET DE SANTE

Couvertes par les normes listées au point 15.

19 VERIFICATIONS ET ESSAIS INDIVIDUELS

Néant.

1 SUPPLEMENTARY EC TYPE EXAMINATION CERTIFICATE

2 Equipment or protective system intended for use in potentially explosive atmospheres (Directive 94/9/EC)

3 Supplementary certificate number : LCIE 06 ATEX 6033 X / 01

4 Equipment or protective system : Vibration sensors
Type : EX602Dxx, EX603Cxx, EX606Bxx, EX607Axx, EX608Axx

5 Applicant : IMI Sensors PCB Piezotronics Div.

15 DESCRIPTION OF THE SUPPLEMENTARY CERTIFICATE

Normative update according to the standards EN 60079-0 (2006) and EN 60079-11 (2007).

The examination and test results are recorded in confidential report N° 95367-590025-02.

Specific parameters of the mode(s) of protection concerned: Unchanged.

The marking shall be : IMI Sensors
Address :
Type : EX 60... (1)
Serial number :Year of construction :
II 1 G Ex ia IIC T4
LCIE 06 ATEX 6033X
T amb. : - 40°C to + 121°C
(1) completed following the model

16 DESCRIPTIVE DOCUMENTS

Certification file N° 33698 Rev. A dated 2010/04/19. This file includes 10 items (22 pages).

17 SPECIAL CONDITIONS FOR SAFE USE

Unchanged.

18 ESSENTIAL HEALTH AND SAFETY REQUIREMENTS

Covered by standards listed at 15.

19 ROUTINE VERIFICATIONS AND TESTS

None.

Fontenay-aux-Roses, le 04 mai 2010.

Le responsable de certification ATEX
ATEX certification manager
Man GILLAUX

Seul le texte en français peut engager la responsabilité du LCIE. Ce document ne peut être reproduit que dans son intégralité, sans aucune modification.
The LCIE's liability applies only on the French text. This document may only be reproduced in its entirety and without any change.



LCIE

1 ATTESTATION D'EXAMEN CE DE TYPE

2 Appareil ou système de protection destiné à être utilisé en atmosphères explosibles (Directive 94/9/CE)

3 Numéro de l'attestation d'examen CE de type
LCIE 06 ATEX 6033 X

4 Appareil ou système de protection :

Capteurs de vibrations

Type : EX602Dxx, EX603Cxx, EX606Bxx, EX607Axx,
EX608Axx

5 Demandeur : IMI Sensors A PCB Piezotronics Div.

Adresse : 3425 Walden Avenue
Depew, New York 14043 USA

6 Fabricant : IMI Sensors A PCB Piezotronics Div.

Adresse : 3425 Walden Avenue
Depew, New York 14043 USA

7 Cet appareil ou système de protection et ses variantes éventuelles acceptées sont décrits dans l'annexe de la présente attestation et dans les documents descriptifs cités en référence.

8 Le LCIE, organisme notifié sous la référence 0081 conformément à l'article 9 de la directive 94/9/CE du Parlement européen et du Conseil du 23 mars 1994, certifie que cet appareil ou système de protection est conforme aux exigences essentielles de sécurité et de santé pour la conception et la construction d'appareils et de systèmes de protection destinés à être utilisés en atmosphères explosibles, données dans l'annexe II de la directive. Les résultats des vérifications et essais figurent dans le rapport confidentiel N° 60042416/542372.

9 Le respect des exigences essentielles de sécurité et de santé est assuré par la conformité à :

- EN 50014 (1997) + amendements 1 et 2
- EN 50020 (2002)

10 Le signe X lorsqu'il est placé à la suite du numéro de l'attestation, indique que cet appareil ou système de protection est soumis aux conditions spéciales pour une utilisation sûre, mentionnées dans l'annexe de la présente attestation.

11 Cette attestation d'examen CE de type concerne uniquement la conception et la construction de l'appareil ou du système de protection spécifié, conformément à l'annexe III de la directive 94/9/CE.

Des exigences supplémentaires de la directive sont applicables pour la fabrication et la fourniture de l'appareil ou du système de protection. Ces dernières ne sont pas couvertes par la présente attestation.

12 Le marquage de l'appareil ou du système de protection doit comporter les informations détaillées au point 15.

Fontenay-aux-Roses, le 22 mai 2006

1 EC TYPE EXAMINATION CERTIFICATE

2 Equipment or protective system intended for use in potentially explosive atmospheres (Directive 94/9/EC)

3 EC type examination certificate number
LCIE 06 ATEX 6033 X

4 Equipment or protective system :

Vibration sensors

Type : EX602Dxx, EX603Cxx, EX606Bxx, EX607Axx,
EX608Axx

5 Applicant : IMI Sensors A PCB Piezotronics Div.

Address : 3425 Walden Avenue
Depew, New York 14043 USA

6 Manufacturer : IMI Sensors A PCB Piezotronics Div.

Address : 3425 Walden Avenue
Depew, New York 14043 USA

7 This equipment or protective system and any acceptable variation thereto is specified in the schedule to this certificate and the documents therein referred to.

8 LCIE, notified body number 0081 in accordance with article 9 of the Directive 94/9/EC of the European Parliament and the Council of 23 March 1994, certifies that this equipment or protective system has been found to comply with the essential Health and Safety Requirements relating to the design and construction of equipment and protective systems intended for use in potentially explosive atmospheres, given in Annex II to the Directive. The examination and test results are recorded in confidential report N° 60042416/542372.

9 Compliance with the Essential Health and Safety Requirements has been assured by compliance with :

- EN 50014 (1997) + amendments 1 and 2
- EN 50020 (2002)

10 If the sign X is placed after the certificate number, it indicates that the equipment or protective system is subject to special conditions for safe use specified in the schedule to this certificate.

11 This EC type examination certificate relates only to the design and construction of this specified equipment or protective system in accordance with annex III to the directive 94/9/EC.

Further requirements of the directive apply to the manufacturing process and supply of this equipment or protective system. These are not covered by this certificate.

12 The marking of the equipment or protective system shall include informations as detailed at 15.

responsable de certification ATEX
ATEX certification manager



[Signature]
Marc CERVILLO

Seul le texte en français peut engager la responsabilité du LCIE. Ce document ne peut être reproduit que dans son intégralité, sans aucune modification
The LCIE's liability applies only on the French text. This document may only be reproduced in its entirety and without any change



LCIE

13 ANNEXE

13 SCHEDULE

14 ATTESTATION D'EXAMEN CE DE TYPE

14 EC TYPE EXAMINATION CERTIFICATE

LCIE 06 ATEX 6033 X

LCIE 06 ATEX 6033 X

15 DESCRIPTION DE L'APPAREIL OU DU SYSTEME DE PROTECTION

15 DESCRIPTION OF EQUIPMENT OR PROTECTIVE SYSTEM

Capteurs de vibrations

Vibration sensors

Type : EX602Dxx, EX603Cxx, EX606Bxx, EX607Axx, EX608Axx

Type : EX602Dxx, EX603Cxx, EX606Bxx, EX607Axx, EX608Axx

Ce capteur est composé d'un ensemble piezo-cristal, d'une carte électronique et d'un connecteur ou un câble intégré.

This apparatus is made of a piezo-crystal assembly, an electronic board and a connector or an integrated cable.

Modèles concernés :

Models concerned :

EX602D01, EX603C01, EX606B01, EX607A01
EX602D11, EX603C11, EX606B11, EX607A11, EX608A11
EX602D61, EX603C61, EX606B61, EX607A61

EX602D01, EX603C01, EX606B01, EX607A01
EX602D11, EX603C11, EX606B11, EX607A11, EX608A11
EX602D61, EX603C61, EX606B61, EX607A61

Paramètres spécifiques du ou des modes de protection concernés :

Specific parameters of the mode(s) of protection concerned:

Modèle / Model	Ui (V)	Ii (mA)	Pi (W)	Ci (nF)	Li (µH)
EX602D01, EX603C01, EX606B01, EX607A01	28	200	1	16,2	0
EX602D11, EX603C11, EX606B11, EX607A11, EX608A11	28	200	1	77,2	305
EX602D61, EX603C61, EX606B61, EX607A61	28	200	1	16,2	305

Le marquage doit être :

The marking shall be :

IMI Adresse :

IMI Address :

Type : EX 60... (1)

Type : EX 60... (1)

N° de fabrication : Année de fabrication :

Serial number : Year of construction :

Ex II 1G EEx ia IIC T4

Ex II 1G EEx ia IIC T4

LCIE 06 ATEX 6033X

LCIE 06 ATEX 6033X

T amb. : - 40°C à + 121°C

T amb. : - 40°C to + 121°C

(1) complété suivant le modèle

(1) completed following the model

L'appareil doit également comporter le marquage normalement prévu par les normes de construction qui le concerne.

The equipment shall also bear the usual marking required by the manufacturing standards applying to such equipment.

16 DOCUMENTS DESCRIPTIFS

16 DESCRIPTIVE DOCUMENTS

Dossier de certification N° 33699 du 28/03/2006.
Ce document comprend 10 rubriques (25 pages).

Certification file N° 33699 dated 28/03/2006.
This file includes 10 items (25 pages).

17 CONDITIONS SPECIALES POUR UNE UTILISATION SÛRE

17 SPECIAL CONDITIONS FOR SAFE USE

Ce matériel est un appareil de sécurité intrinsèque, il peut être placé en atmosphère explosible.

This equipment is an intrinsically safe apparatus, it can be mounted in explosive atmosphere.

Le matériel ne doit être raccordé qu'à un matériel associé de sécurité intrinsèque certifié et cette association doit être compatible du point de vue sécurité intrinsèque (voir paramètres électriques au paragraphe 15).

The apparatus must be only connected to a certified associated intrinsically safe equipment and this combination must be compatible regarding intrinsic safety rules (see electrical parameters clause 15).

Température ambiante d'utilisation : - 40°C à + 121°C.

Operating ambient temperature : - 40°C to + 121°C.

18 EXIGENCES ESSENTIELLES DE SECURITE ET DE SANTE

18 ESSENTIAL HEALTH AND SAFETY REQUIREMENTS

Couvertes par les normes listées au point 9.

Covered by standards listed at 9.

19 VERIFICATIONS ET ESSAIS INDIVIDUELS

19 ROUTINE VERIFICATIONS AND TESTS

Néant.

None.



LCIE

Fontenay-aux-Roses, August 23th, 2013

PCB Piezotronics (IMI Sensors)

Attention to Mr Nick FULCINITI

3425 Walden avenue

Depew, New York 14086

USA

N/Réf. : MEq/013386
DHL : + 716 684 0002

DISPATCH NOTE

Documents	Number
EC type_examination certificate LCIE 06 ATEX 6032 X/02 EC type_examination certificate LCIE 06 ATEX 6033 X/02 IECEX LCIE 13.0045X Issue 00 Technical file authenticated + test report FR/LCIE/ExTR13.0040/00 (File N°120351-640382)	Original Original Original Original

Best regards,

Michel EQUI

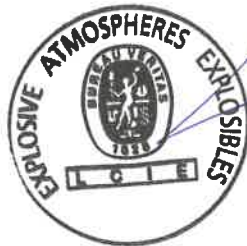

SIL Declaration of Conformity
Functional safety according to IEC 61508

Manufacturer: PCB Piezotronics
3425 Walden Avenue
Depew, NY 14043 USA

PCB Piezotronics declares as manufacturer, that the vibration transmitters:

- 602 Series (XX)602yzzz/aaa
- 603 Series (XX)603yzzz/aaa
- 606 Series (XX)606yzzz/aaa
- 607 Series (XX)607yzzz/aaa
- 608 Series (XX)608yzzz/aaa

(XX) Options include one or more of the following:

- EX – Approved for Hazardous Locations
- M – Metric Mounting Hardware
- TO – Dual Output (Vibration/Temperature)

Note: “yzzz” completes the model, “aaa” indicates cable length (if applicable)

Is hardware suitable for use in safety-instrumented systems according to IEC 61508, if the safety instructions and the following parameters are observed:

Parameter	60x Series*	EX60x Series*
SIL	2	2
Proof Test Interval (Annual)	8,760 h	8,760 h
Device Type	B	B
HFT	0	0
SFF	79.59%	79.59%
PFD _{AV} ¹	7.45 x 10 ⁻⁵	7.45 x 10 ⁻⁵
$\lambda_{du} \times 10^{-6}$	0.3348	0.3348
SIL Capability (Low Demand Mode)	2	2
SIL Capability (Continuous Demand Mode)	2	2
MTTF ²	9.5 y	9.5 y
1. The values comply with SIL2 according to ISA S84.01 2. According to Siemens SN29500 and Proven In Use data		

* With or without the M (metric) option

The PCB sensor hardware is suitable for inclusion in Safety Instrumented Systems (SIS) that are designed using IEC 61511 (for the process industry sector), IEC 62061 (safety of machinery), EN 50129 (railway applications), and ISO 26262 (automotive industry).

Note: The use of SIL Hardware in specific safety standard application may apply different number of sequences or definitions to those in IEC 61508.

July 2, 2019

PCB Piezotronics Authorized Representative:

Carrie Termin
Regulatory Affairs and Product Certification Specialist



PCB PIEZOTRONICS, INC. — CORPORATE HEADQUARTERS

3425 Walden Avenue, Depew, New York 14043-2495 USA

Phone: 716-684-0001 Fax: 716-684-0987

E-mail: info@pcb.com

Web site: www.pcb.com

**AS9100 and ISO9001 Certified
ISO17025 Accredited**

INTERTEK ASSURANCE SAFETY INTEGRITY LEVEL SUMMARY REPORT 60X PCB SIL SENSOR RATING

CLIENT NAME

PCB Piezotronics, Inc.
3425 Walden Ave
Depew, NY 14043-2417

REPORT NO

103685042CSLT-003

COMPILED BY

Ashton D. Hainge, CFSP, PMP

PROJECT NAME

G103685042

DATE

02 April 2019

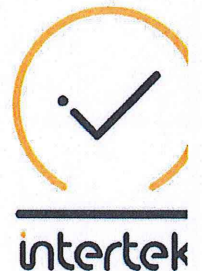
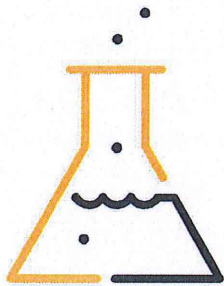
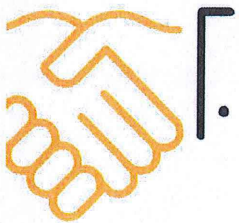



PCB FUNCTIONAL SAFETY SIL SUMMARY AND RESULTS

Summary

This report details the results of the reliability analysis performed on the PCB Piezotronics ICP Sensor model 60X series. Design changes from this documentation package would need to be evaluated for the impact on the reliability characteristics. These results are based on the following PCB Piezotronics documentation:

1. Electrical schematic 23402-NR
2. 603C01 MTTF Calculation
3. 602C11 – 602D11 MTTF Calculation
4. 607-608 MTTF Calculation
5. Manual of 603C01

Results

The results from the FMEA are given below for the ICP Sensor model 60X Series:

Name	Result
Architecture	1oo1
Proof test interval (Annual)	8,760 h
PFD _{avg}	7.45x10 ⁻⁵
SFF	79.59%
HFT	0
SIL Capability (Low Demand Mode)	2
SIL Capability (Continuous Demand Mode)	2
Architecture	1oo1

PCB Sensor Product Meets SIL 2 Capability



Name		Result
Safe Detected failure rate	$\lambda_{SD} \times 10^{-6}$	0.019
Safe Undetected failure rate	$\lambda_{SU} \times 10^{-6}$	0.013
Dangerous Detected failure rate	$\lambda_{DD} \times 10^{-6}$	0.033
Dangerous Undetected failure rate	$\lambda_{DU} \times 10^{-6}$	0.017
Average frequency of a dangerous failure on demand	PFH $\times 10^{-6}$	0.796

Type B components: 60X Series

The safety relevant parameter PFD_{avg} is in compliance with the corresponding requirements for SIL 2 according to IEC 61508¹. The safety relevant parameters HFT and SFF are in compliance with the corresponding requirements for SIL 1 according to IEC 61508. The user should consider, that the hardware fault tolerance of all inspected devices is zero and that a single fault can lead to a dangerous failure. Even though PFD_{avg} has the range of SIL 4, the hardware fault tolerance limits the capability to SIL 2.

Senior Consultant,

Ashton Hainge, Intertek
CFSP, PMP

¹ The assessment results described in this report only refer to the safety-related parameters PFD avg, HFT, and SFF according to IEC 61508.

This report does not make any statements, that the manufacturer meets all other requirements of the above cited standards for hardware, software, documentation, management of functional safety, verification, and validation.

This report does not imply that the examined pressure sensors have been certified for functional safety by the assessor according to IEC 61508 or any other standards.

The sensors are only one part of a complete safety function. It is at the responsibility of the end-user to prepare and to apply an extensive reliability model, that brings out the complete safety function and that meets all requirements of the claimed SIL level according to IEC 61508.

EU Declaration of Conformity PS060

In Accordance with ISO/IEC 17050

Manufacturer:
 PCB Piezotronics, Inc.
 3425 Walden Avenue
 Depew, New York 14043
 USA

Authorized European Representative:
 PCB Piezotronics Europe GmbH
 Porschestraße 20-30
 41836 Hückelhoven
 Germany

Certifies that type of equipment: ICP® Industrial Sensor(s)

Whose Product Models Include: EX(XX)602yzzz/aaa, EX(XX)603yzzz/aaa, EX(XX)606yzzzlaaa, EX(XX)607yzzz/aaa, EX(XX)608yzzz/aaaSeries

Note: "xx" is a place holder for two numbers.

For example: EX602D01Industrial Vibration Sensor
 These letters and numbers are included in the model numbers of the series. For details see the related data sheets.

This declaration is applicable to all Sensor(s) of the above series which have the CE & (EX) ATEX mark on their data sheets and where those data sheets refer to this declaration of conformity. The data sheets for all model numbers referenced above, which include the CE & (EX) ATEX mark on such data sheets and refer to this Declaration of Conformity are hereby incorporated by reference into this Declaration.

Conform to the following EU Directive(s) when installed per product documentation:

2014/30/EU
 2014/34/EU
 2011/65/EU w/2015/863/EU

EMC Directive
 ATEX Directive
 RoHS Directive

Harmonized Standards to which Conformity is Declared:

Harmonized Standards	EN 61326-1:2013 EN 61326-2-3: 2013 EN 61010-1:2010 EN 61010-1:2010/A1:2019/AC:2019-04 EN 61010-1:2010/A1:2019 EN 60079-0:2018 EN 60079-11 2012 EN 63000:2018	Electrical Equipment for Measurement, Control and Laboratory Use- EMC requirements - Part 1: General requirements Electrical equipment for measurement, control and laboratory use - EMC requirements - Part 2-3: Particular requirements - Test configuration, operational conditions and performance criteria for transducers with integrated or remote signal conditioning Safety Requirements for Electrical Equipment for Measurement, Control, and Laboratory Use - Part 1: General Requirements General Explosive Atmosphere Intrinsic safe, i Technical documentation for the assessment of electrical and electronic products with respect to the restriction of hazardous substances(IEC 63000:2016)
Emissions Test Standards	EN 55011:2016, EN 55011:2016/A1:2017 EN 55011:2016/A11:2020	Industrial, scientific and medical (ISM) radio frequency equipment-Electromagnetic disturbance characteristics- Limits and methods of Measurement Class B
Other Standards Applied (non-OJEU)	EN 61000-4-2:2009 EN 61000-4-3:2006+A2:2010	Electromagnetic compatibility (EMC)–Part 4–2: Testing and measuring techniques– Electrostatic discharge immunity test Electromagnetic compatibility (EMC) - Part 4-3: Testing and measurement techniques - Radiated, radio-frequency, electromagnetic field immunity test

Immunity Test Standards	EN 61000-4-4:2012 EN 61000-4-5:2014 EN 61000-4-6:2014 EN 61000-4-8:2010	Electromagnetic compatibility (EMC) - Part 4-4: Testing and measurement techniques - Electrical fast transient/burst immunity test Electromagnetic compatibility (EMC) - Part 4-5: Testing and measurement techniques - Surge immunity test Electromagnetic compatibility (EMC) - Part 4-6: Testing and measurement techniques - Immunity to conducted disturbances, induced by radio-frequency fields Electromagnetic compatibility (EMC) – Part 4-8: Testing and measurement techniques – Power frequency magnetic field immunity test
Test Reports	EMC Reports Safety Reports	GM29028c, GM29030c, GM29032c, GM29045c GM29029s, GM29031s, GM29033s, GM29046s
EC Type Examination	ATEX Certification	LCIE 06 ATEX 6033 X Ex ia IIC T4 Ga, II 1 G
Voluntary Certification	Voluntary Type Examination Certificate	LCIE 06 ATEX 6032 X Ex nA IC T4 Gc, II 3 G
Other International Certifications	IECEX Certification	IECEX LCIE 13.0045 X Ex ia IIC T4 Ga Ex nA IICT4 Gc
Notified Body Name		Laboratoire Central des Industries Electriques (0081)
Notified Body's Address		FONTENAY-AUX-ROSES (Head Office) 33, avenue du Général Leclerc FR- 92260 Fontenay-aux-Roses Tel. : + 33 1 40 95 60 60 Fax : + 33 1 40 95 86 56

I, the undersigned, hereby declare that the equipment specified above conforms to the above Directive(s) Standard(s)

Place: Depew, NY **Date:** 4/9/2023

Signature:



Name: Wendy Willard

Title: Regulatory Affairs and Product Certification Specialist



Certificate of Compliance

Certificate: 1469131

Master Contract: 184981

Project: 80008175

Date Issued: 2019-07-23

Issued To: PCB Piezotronics
3425 Walden Ave
Depew, New York, 14043
United States

Attention: Carrie Termin

The products listed below are eligible to bear the CSA Mark shown with adjacent indicators 'C' and 'US' for Canada and US or with adjacent indicator 'US' for US only or without either indicator for Canada only.



Issued by: Hossein Saleh
Hossein Saleh

PRODUCTS

CLASS 2258 04 - PROCESS CONTROL EQUIPMENT - Intrinsically Safe, Entity - For Hazardous Locations

CLASS 2258 84 - PROCESS CONTROL EQUIPMENT - Intrinsically Safe, Entity - For Hazardous Locations - Certified to US Standards

**Class I, Div. 1, Groups A, B, C and D; Class II, Div. 1, Groups E, F and G; Class III, Div. 1
Ex ia IIC T4
AEx ia IIC T4**

Generic Model Nomenclature:

a = TO or blank where TO is Temperature Output Option
b = M or blank where M is Metric stud option



Certificate: 1469131
Project: 80008175

Master Contract: 184981
Date Issued: 2019-07-23

c = any alpha digit as follows dealing with changes not affecting the certification:

A-Z for EX602 series

A-Z for EX603 series

A-Z for EX606 series

A-Z for EX607 and EX608 series

d = any numeric digit denoting connector style or integral cable

e = any numeric digit denoting variations in sensor sensitivity

Two Wire Models that pertain to schematic 71758:

- Model EXab602cde, EXab603cde, EXab606cde, EXab607cde and EXab608cde Vibration Sensors, input rated 28 Vdc max, 20 mA; intrinsically safe with entity parameters of: $U_i (V_{max}) = 28 \text{ V}$, $I_i (I_{max}) = 93 \text{ mA}$, $P_i = 0.65 \text{ W}$, $C_i = 46.5 \text{ nF}$, $L_i = 0$; when installed per installation drawing 29876; Temperature Code T4 at maximum ambient 121 °C.

- Model EXab602cde, EXab603cde, EXab606cde, EXab607cde and EXab608cde Vibration Sensors, input rated 28 Vdc max, 20 mA; intrinsically safe with entity parameters (for models with integral cables up to 500 feet) of: $U_i (V_{max}) = 28 \text{ V}$, $I_i (I_{max}) = 93 \text{ mA}$, $P_i = 0.65 \text{ W}$, $C_i = 77 \text{ nF}$, $L_i = 152.5 \mu\text{H}$; when installed per installation drawing 29876; Temperature Code T4 at maximum ambient 121 °C.

- Model 200350 Vibration Sensors, input rated 28 Vdc max, 20 mA max; intrinsically safe with entity parameters of: $U_i (V_{max}) = 30\text{V}$, $I_i (I_{max}) = 200\text{mA}$, $P_i = 1 \text{ W}$, $C_i = 16.2 \text{ nF}$, $L_i = 0$; when installed per installation drawing 22775; Temperature Code T4 at maximum ambient 121 °C.

Three Wire Models that pertain to schematic 45280:

- Model EXab602cde, EXab603cde, EXab606cde, EXab607cde, EXab608cde Vibration Sensors, intrinsically safe with entity parameters of: $U_i (V_{max}) = 8 \text{ V}$, $I_i (I_{max}) = 160 \text{ mA}$, $P_i = 1 \text{ W}$, $C_i = 44.6 \text{ nF}$, $L_i = 100 \mu\text{H}$; when installed per installation drawing 45279; Temperature Code T4 at maximum ambient 121 °C.

CLASS 2258 03 - PROCESS CONTROL EQUIPMENT - Intrinsically Safe and Non-Incendive Systems - For Hazardous Locations

CLASS 2258 83 - PROCESS CONTROL EQUIPMENT - Intrinsically Safe and Non-Incendive Systems - For Hazardous Locations – Certified to U.S. Standards

Class I, Div. 2, Groups A, B, C and D

Ex nL IIC T4

AEx nA IIC T4

Generic Model Nomenclature:

a = TO or blank where TO is Temperature Output Option

b = M or blank where M is Metric stud option

c = any alpha digit as follows dealing with changes not affecting the certification:

A-Z for EX602 series



Certificate: 1469131
Project: 80008175

Master Contract: 184981
Date Issued: 2019-07-23

A-Z for EX603 series

A-Z for EX606 series

A-Z for EX607 and EX608 series

d = any numeric digit denoting connector style or integral cable

e = any numeric digit denoting variations in sensor sensitivity

Two Wire Models that pertain to schematic 71758:

- Model EXab602cde, EXab603cde, EXab606cde, EXab607cde and EXab608cde Vibration Sensors, input rated 28 Vdc max, 20 mA; non-incendive with entity parameters (for connector versions) of: U_i (V_{max}) = 28 V, I_i (I_{max}) = 93 mA, P_i = 0.65 W, C_i = 46.5 nF, L_i = 0; when installed per installation drawing 29876; Temperature Code T4 at maximum ambient 121 °C.

- Model EXab602cde, EXab603cde, EXab606cde, EXab607cde and EXab608cde Vibration Sensors, input rated 28 Vdc max, 20 mA; non-incendive with entity parameters (for models with integral cables up to 500 feet) of: U_i (V_{max}) = 28 V, I_i (I_{max}) = 93 mA, P_i = 0.65 W, C_i = 77 nF, L_i = 152.5 μ H; when installed per installation drawing 29876; Temperature Code T4 at maximum ambient 121 °C.

- Model 200350 Vibration Sensor, input rated 28 Vdc max, 20 mA max; non-incendive when connected to CSA Certified Power/Signal Monitoring units when installed per installation drawing 22775; Temperature Code T4 at maximum ambient 121 °C.

Three Wire Models that pertain to schematic 45280:

- Model EXab602cde, EXab603cde, EXab606cde, EXab607cde, EXab608cde Vibration Sensors, non-incendive with entity parameters of: U_i (V_{max}) = 8 V, I_i (I_{max}) = 160 mA, P_i = 1 W, C_i = 44.6 nF, L_i = 100 μ H; when installed per installation drawing 45279; Temperature Code T4 at maximum ambient 121 °C.

Conditions of Acceptability:

1. For Canadian Installations, sensor case must be bonded to ground according to CEC, Part 1.
2. For US Installations, sensor case must be bonded to ground according to NEC.



Certificate: 1469131
Project: 80008175

Master Contract: 184981
Date Issued: 2019-07-23

APPLICABLE REQUIREMENTS

CAN/CSA Std C22.2 No. 0-M91	General Requirements – Canadian Electrical Code, Part II
CSA Std C22.2 No. 142-M1987	Process Control Equipment
CSA STD C22.2 No. 213-16	Non-Incendive Electrical Equipment for Use in Class I, Division 2 Hazardous Locations
CAN/CSA-C22.2 No. 157-92	Intrinsically Safe and Non-Incendive Equipment for Use in Hazardous Locations
CAN/CSA-E60079-0:02	Electrical apparatus for explosive gas atmospheres - Part 0: General Requirements
CAN/CSA- E60079-11:02	Electrical apparatus for explosive gas atmospheres - Part 11: Intrinsic Safety “i”
CAN/CSA- E60079-15:02	Electrical apparatus for explosive gas atmospheres - Part 15: Type of Protection “n”
UL Std No. 916	Energy Management Equipment
UL Std No. 913	Intrinsically Safe Apparatus and Associated Apparatus for Use in Class I, II and III, Division 1, Hazardous Locations
ANSI/ISA 12.12.01-2015	Nonincendive Electrical Equipment for Use in Class I and II, Division 2 and Class III, Divisions 1 and 2 Hazardous (Classified) Locations
FM Std. No. 3600-1998	Electrical Equipment for Use in Hazardous (Classified) Locations – General Requirements
FM Std. No. 3611-1999	Nonincendive Electrical Equipment for Use in Class I and II, Division 2, and Class III, Divisions 1 and 2, Hazardous (Classified) Locations
ANSI/UL 60079-0:02	Electrical Apparatus for Explosive Gas Atmospheres - Part 0: General Requirements
ANSI/UL 60079-11:02	Electrical Apparatus for Explosive Gas Atmospheres - Part 11: Intrinsic Safety “i”
ANSI/UL 60079-15:02	Electrical Apparatus for Explosive Gas Atmospheres - Part 15: Type of Protection “n”



Certificate: 1469131
Project: 80008175

Master Contract: 184981
Date Issued: 2019-07-23

MARKINGS

I.S. models

- CSA Monogram with C US Indicator
- Submitter Identification
- Model Number
- Serial Number, Date Code or Month and Year of Manufacture
- Electrical Rating
- Hazardous Location Designation (i.e., the symbol Ex ia IIC T4; AEx ia IIC T4; Class I, Div. 1, Groups A, B, C and D; Class II, Div. 1, Groups E, F and G; Class III, Div. 1)
- Certificate # reference (i.e., 2006 1469131)
- Reference to Installation Instructions

Div. 2 Non-Incendive models

- CSA Monogram with C US indicator.
- Submitter Identification
- Model Number
- Serial Number, Date Code or Month and Year of Manufacture
- Electrical Rating
- Hazardous Location Designation (i.e., Ex nL IIC T4, AEx nA IIC T4, Class I, Div. 2, Groups A, B, C and D)
- Certificate # reference (i.e., 2006 1469131)



Supplement to Certificate of Compliance

Certificate: 1469131

Master Contract: 184981

The products listed, including the latest revision described below, are eligible to be marked in accordance with the referenced Certificate.

Product Certification History

Project	Date	Description
80008175	2019-07-23	Update Report 1469131 to cover changes applicable to Two Wire Model Vibration Sensors that pertain to schematic 71758 and are used in Class I/II/III Division 1, Zone 0; and, Class I Division 2, Zone 2. Updates include: Addition of three capacitors; A change in values of Entity Parameters.
000070125525	2017-09-05	Update CSA Report 1469131 to assess the modified entity parameters for the 3 wire type Vibration Sensors.
000070079443	2016-07-15	Update Report 1469131 to assess the replacing of a new temperature output chip LM45 instead of old sensor temperature output chip LM35 for Class I, Div 1, Groups A, B, C, D, Class II, Div 1, Groups E, F and G ,Class III, Div 1 A/Ex ia IIC for all EXTO models indicated on the original report 1469131. Model No: EXab607cde and EXab608cde and ab608cde with New Temperature output chip LM45 for the #EXTO# models
0002625009	2013-07-19	Update to report 1469131 to include revised drawings and remove "Date" column from the Descriptive Document List.
0002285154	2010-04-14	Update of Report 1469131 to include models EXab602cde, EXab603cde, EXab606cde, EXab607cde, and EXab608cde.
0001750643	2006-04-18	Update to Include models EX602Dxx, EX606Bxx, EX607Axx and EX608A1x; addition of models EX603C1x and EX603C6x.
0001469131	2003-08-22	Original Certification - Models 603C01 and 200350.

СЕРТИФИКАТ СООТВЕТСТВИЯ



№ ЕАЭС RU C-US.AA87.B.00217/19



Серия RU № 0124866

ОРГАН ПО СЕРТИФИКАЦИИ Орган по сертификации взрывозащищенного и рудничного оборудования (ОС ЦСВЭ) Общества с ограниченной ответственностью «Центр по сертификации взрывозащищенного и рудничного оборудования» (ООО «НАНИО ЦСВЭ»). Адрес места нахождения юридического лица: Россия, 140004, Московская область, Люберецкий район, город Люберцы, поселок ВУГИ, АО «Завод «ЭКОМАШ», литера В, Объект 6, этаж 3, офис 26. Адрес места осуществления деятельности в области аккредитации: Россия, 140004, Московская область, Люберецкий район, город Люберцы, поселок ВУГИ, АО «Завод «ЭКОМАШ», Литера В, Объект 6, этаж 3, офисы 26/3, 26/4, 26/5, 27/6, 30/1, 32. Аттестат № RA.RU.11AA87 от 20.07.2015 г. Телефон: +7 (495) 558-83-53, +7 (495) 558-82-44. Адрес электронной почты: ccve@ccve.ru

ЗАЯВИТЕЛЬ Общество с ограниченной ответственностью «Альфатех». Адрес места нахождения юридического лица: Россия, 125009, Москва, Малый Гнезниковский переулок, дом № 12, помещение I, комната 4. Адрес места осуществления деятельности: Россия, 127495, Москва, Долгопрудненское шоссе, дом № 3, Технопарк «Физтехпарк». ОГРН: 1167746393792. Телефон: +7 (495) 642-49-14. Адрес электронной почты: info@alphatechgroup.ru

ИЗГОТОВИТЕЛЬ PCB Piezotronics, Inc Адрес места нахождения юридического лица и адрес места осуществления деятельности по изготовлению продукции: 3425 Walden Av., Depew, NY 14043, США

ПРОДУКЦИЯ Пьезоэлектрические преобразователи, вибропереключатели, предусилители с Ex-маркировкой согласно приложению (см. бланки №№ 0621345, 0621346, 0621347). Документы, в соответствии с которыми изготовлены изделия – см. приложение, бланк № 0621344. Серийный выпуск.

КОД ТН ВЭД ЕАЭС 9031 80 3800, 9026 20 2000, 8517 69 9000

СООТВЕТСТВУЕТ ТРЕБОВАНИЯМ ТР ТС 012/2011 «О безопасности оборудования для работы во взрывоопасных средах».

СЕРТИФИКАТ СООТВЕТСТВИЯ ВЫДАН НА ОСНОВАНИИ Протокола испытаний № 235.2019-Т от 11.09.2019 Испытательной лаборатории технических устройств Автономной некоммерческой организации «Национальный испытательный и научно-исследовательский институт оборудования для взрывоопасных сред» ИЛ Ex TU (аттестат № РОСС RU.0001.21MШ19 от 16.10.2015); Акта анализа состояния производства № 35-А/19 от 14.03.2019 Органа по сертификации взрывозащищенного и рудничного оборудования (ОС ЦСВЭ) Общества с ограниченной ответственностью «Центр по сертификации взрывозащищенного и рудничного оборудования» (ООО «НАНИО ЦСВЭ») (аттестат № RA.RU.11AA87 выдан 20.07.2015); Документов, представленных заявителем в качестве доказательства соответствия продукции требованиям ТР ТС 012/2011 (см. приложение, бланк № 0621344). Схема сертификации – 1с.

ДОПОЛНИТЕЛЬНАЯ ИНФОРМАЦИЯ Перечень стандартов, применяемых на добровольной основе для соблюдения требований ТР ТС 012/2011 (см. приложение, бланк № 0621344). Условия и срок хранения указаны в эксплуатационной документации. Назначенный срок службы – 10 лет.

СРОК ДЕЙСТВИЯ С 13.09.2019 ПО 12.09.2024 ВКЛЮЧИТЕЛЬНО

Руководитель (уполномоченное лицо) органа по сертификации

(подпись)

Залогин Александр Сергеевич

(Ф.И.О.)

Эксперт (эксперт-аудитор) (эксперты (эксперты-аудиторы))

(подпись)

М.П. Рафалович Борис Александрович

(Ф.И.О.)



ПРИЛОЖЕНИЕ

К СЕРТИФИКАТУ СООТВЕТСТВИЯ № ЕАЭС RU C-US.AA87.B.00217/19 Лист 1

Серия RU № 0621344

**I. ПЕРЕЧЕНЬ СТАНДАРТОВ, ПРИМЕНЯЕМЫХ НА ДОБРОВОЛЬНОЙ ОСНОВЕ
ДЛЯ СОБЛЮДЕНИЯ ТРЕБОВАНИЙ ТР ТС 012/2011 «О БЕЗОПАСНОСТИ ОБОРУДОВАНИЯ
ДЛЯ РАБОТЫ ВО ВЗРЫВООПАСНЫХ СРЕДАХ»**

Обозначение стандартов	Наименование стандартов
ГОСТ 31610.0-2014 (IEC 60079-0:2011)	Взрывоопасные среды. Часть 0. Оборудование. Общие требования
ГОСТ IEC 60079-1-2011	Взрывоопасные среды. Часть 1. Оборудование с видом взрывозащиты «взрывонепроницаемые оболочки «d»
ГОСТ 31610.11-2014 (IEC 60079-11:2011)	Взрывоопасные среды. Часть 11. Оборудование с видом взрывозащиты «искробезопасная электрическая цепь «i»
ГОСТ 31610.15-2012/МЭК 60079-15:2005	Электрооборудование для взрывоопасных газовых сред. Часть 15. Конструкция, испытания и маркировка электрооборудования с видом защиты «п»

**II. ДОКУМЕНТЫ, ПРЕДСТАВЛЕННЫЕ ЗАЯВИТЕЛЕМ В КАЧЕСТВЕ ДОКАЗАТЕЛЬСТВА
СООТВЕТСТВИЯ ПРОДУКЦИИ ТРЕБОВАНИЯМ ТР ТС 012/2011**

Руководства по эксплуатации: № 750119 от 23.01.19, № 830119 от 23.01.19, № 940219 от 07.02.19, № 630119 от 22.01.19, № 610119 от 22.01.19, № 910219 от 07.02.19, № 950219 от 08.02.19, № 970219 от 08.02.19.
Технические файлы: № 54202 от 02.02.2017, № 54204 от 02.02.2017, № 22438 С от 19.07.2012, № 62501 от 06.10.2016, № 33699 от 16.06.2016, № 56178 от 01.07.2016, № 70893 от 24.07.2019, № 54707 от 10.08.2016, № 48813 от 06.01.2011
Чертежи: № 47912 от 31.03.2017, № 49038 от 31.03.2017.
Перечень стандартов см. п. I.

III. ДОКУМЕНТЫ, В СООТВЕТСТВИИ С КОТОРЫМИ ИЗГОТОВЛЕНА ПРОДУКЦИЯ

Технические файлы: № 54202 от 02.02.2017, № 54204 от 02.02.2017, № 22438 С от 19.07.2012, № 62501 от 06.10.2016, № 33699 от 16.06.2016, № 56178 от 01.07.2016, № 70893 от 24.07.2019, № 54707 от 10.08.2016, № 48813 от 06.01.2011
Чертежи: № 47912 от 31.03.2017, № 49038 от 31.03.2017

Руководитель (уполномоченное
лицо) органа по сертификации

(подпись)

Эксперт (эксперт-аудитор)
(эксперты (эксперты-аудиторы))

(подпись)



Залогин Александр Сергеевич
(Ф.И.О.)

М.П.

Рафалович Борис Александрович
(Ф.И.О.)

ПРИЛОЖЕНИЕ

К СЕРТИФИКАТУ СООТВЕТСТВИЯ № ЕАЭС RU C-US.AA87.B.00217/19 Лист 2

Серия **RU** № **0621345**

1. НАЗНАЧЕНИЕ И ОБЛАСТЬ ПРИМЕНЕНИЯ

Пьезоэлектрические преобразователи (далее – преобразователи) предназначены для контроля параметров вибрации, динамического давления и преобразования их в электрический сигнал.

Вибропереключатели предназначены для контроля уровня вибрации и защиты оборудования от повышенной вибрации.

Предусилители предназначены для преобразования зарядового сигнала в вольтовый.

Область применения - взрывоопасные зоны помещений и наружных установок согласно Ex-маркировке, ГОСТ IEC 60079-14-2013, регламентирующих применение во взрывоопасных средах.

2. СТРУКТУРНОЕ ОБОЗНАЧЕНИЕ

2.1. Преобразователи 176ХУУ/МZZZ-АА

X = от А до Z ревизия продукта, не влияющая на взрывозащиту

УУ = от 01 до 99 для индикации вариантов монтажа, диафрагмы, кабелей или разъемов

M = опционально для указания метрической длины кабеля

ZZZ = от 001 до 999 опционально для указания длины кабеля в футах: (не более 200 футов) или метрах: (не более 61 м)

AA = от 01 до 99 опционально для указания дробной длины кабеля в дюймах или сантиметрах, не влияющей на взрывозащиту

2.2. Преобразователи 351abcd

a – ревизия продукта, может быть: А,В,С,Д,Е,Ф,Г,Н,І,Ј,К,Л или М, не влияющая на взрывозащиту

b – первая цифра вариации продукта, может быть: 0,1,2,3,4,5,6,7,8 или 9, не влияющая на взрывозащиту

c – вторая цифра вариации продукта, может быть: 0,1,2,3,4,5,6,7,8 или 9, не влияющая на взрывозащиту

d – третья цифра вариации продукта, может быть: 0,1,2,3,4,5,6,7,8,9 или отсутствует, не влияющая на взрывозащиту

2.3 Преобразователи EX(TO)(M)602yzzz/aaa, EX(TO)(M)603yzzz/aaa, EX(TO)(M)606yzzz/aaa, EX(TO)(M)607yzzz/aaa, EX(TO)(M)608yzzz/aaa, EX(M)637XYYYZ, (M)638XYYYZ

XX = TO (с температурным выходом), M (с метрической резьбой),

y = одна буква от А до Z, не влияющая на взрывозащиту

zzz = две или три цифры от 00 до 999, не влияющие на взрывозащиту

aaa = длина кабеля и/или тип разъема

2.4 Предусилители EX682XYYY

X – ревизия продукта (А,В ... М), не влияющая на взрывозащиту

YYY: параметры фильтрации, усиления, частотная характеристика, ... (от 1 до 999), не влияющие на взрывозащиту

2.5 Преобразователи EX(RV)(TO)(M)64хухх, EX(RV)(TO)(M)649ухх, EX (RV)(TO) (M)686ухх

XX = M (с метрической резьбой), TO (с температурным выходом), RV (с доп. вольтовым выходом).

Буквы х являются переменными цифрами (значения от 0 до 9), не влияющими на взрывозащиту

y = одна буква от А до Z, не влияющая на взрывозащиту

2.6 Преобразователи EX (XX) 622yzzz / aaa, EX (XX) 623yzzz / aaa, EX (XX) 625yzzz / aaa, EX (XX) 628yzzz / aaa

XX = HT (Высокотемпературная версия), M (с метрической резьбой), TO (с температурным выходом), VO (с выходом по скорости).

y = одна буква от А до Z, не влияющая на взрывозащиту

zzz = две или три цифры от 00 до 999, не влияющие на взрывозащиту

aaa = длина кабеля и/или тип разъема

2.7 Вибропереключатели 685ухх

Буквы х являются переменными цифрами (значения от 0 до 9), не влияющими на взрывозащиту

y = одна буква от А до Z, не влияющая на взрывозащиту

Руководитель (уполномоченное
лицо) органа по сертификации

(подпись)

Залогин Александр Сергеевич
(Ф.И.О.)

Эксперт (эксперт-аудитор)
(эксперты (эксперты-аудиторы))

(подпись)

Рафалович Борис Александрович
(Ф.И.О.)

ПРИЛОЖЕНИЕ

К СЕРТИФИКАТУ СООТВЕТСТВИЯ № ЕАЭС RU C-US.AA87.B.00217/19 Лист 3

Серия **RU** № **0621346**

3. ОСНОВНЫЕ ТЕХНИЧЕСКИЕ ДАННЫЕ

3.1. Ех-маркировка: преобразователей 176XYU/MZZ-AA	0Ex ia IIC T660°C...T6 Ga X
преобразователей 351abcd	0Ex ia IIC T4 Ga X
вибропереключателей 685yxx	1Ex d IIB+H ₂ T4 Gb
преобразователей EX(TO)(M)602yzzz1aaa, EX(TO)(M)603yzzz/aaa, EX(TO)(M)606yzzz/aaa, EX(TO)(M)607yzzz/aaa, EX(TO)(M)608yzzz/aaa	2Ex nA IIC T4 Gc X или 0Ex ia IIC T4 Ga X
преобразователей EX(M)637XYUZY, (M)638XYUZY	0Ex ia IIC T4 Ga X или 2Ex nA IIC T4 Gc X
предусилителей EX682XYUZY	0Ex ia IIC T4 Ga X или 2Ex nA IIC T4 Gc X
EX(RV)(TO)(M)64хyxx, EX(RV)(TO)(M)649yxx, EX (RV)(TO) (M)686yxx	1Ex d IIC T4 Gb X или 1Ex d IIC T3 Gb X
преобразователей EX (XX) 622yzzz / aaa, EX (XX) 623yzzz / aaa, EX (XX) 625yzzz / aaa , EX (XX) 628yzzz / aaa	2Ex nA IIC T4 Gc X
3.2. Диапазон температур окружающей среды, °С, преобразователей 176XYU/MZZ-AA	от -70 до 650
преобразователей 351abcd	от -196 до 121
вибропереключателей 685yxx	от -25 до 60
преобразователей EX(TO)(M)602yzzz1aaa, EX(TO)(M)603yzzz/aaa, EX(TO)(M)606yzzz/aaa, EX(TO)(M)607yzzz/aaa, EX(TO)(M)608yzzz/aaa	от -54 до 121
преобразователей EX(M)637XYUZY, (M)638XYUZY	от -196 до 121
предусилителей EX682XYUZY	от -40 до 85
преобразователей EX(RV)(TO)(M)64хyxx, EX(RV)(TO)(M)649yxx, EX (RV)(TO) (M)686yxx	от -20 до 80
преобразователей EX (XX) 622yzzz / aaa, EX (XX) 623yzzz / aaa, EX (XX) 625yzzz / aaa , EX (XX) 628yzzz / aaa	от -54 до 121

3.3. Входные искробезопасные электрические параметры преобразователей, предусилителей:

Модель	U _i , В	I _i , мА	P _i , Вт	C _i , нФ	L _i , мГн
преобразователей 176XYU/MZZ-AA	30	300	1	5	0,5
преобразователей 351abcd	28	200	1,2	61	305 мкГн
преобразователей EX(TO)(M)602yzzz1aaa, EX(TO)(M)603yzzz/aaa, EX(TO)(M)606yzzz/aaa, EX(TO)(M)607yzzz/aaa, EX(TO)(M)608yzzz/aaa	28	200	1	16,2 или 77,2 (с кабелем)	пренебрежимо мала или 305 мкГн (с учетом кабеля 305м)
преобразователей EX(M)637XYUZY, (M)638XYUZY	28	93	0,65	6,5	пренебрежимо мала
предусилителей EX682XYUZY	28	100	0,7	пренебрежимо мала	пренебрежимо мала

Руководитель (уполномоченное
лицо) органа по сертификации

(подпись)

Эксперт (эксперт-аудитор)
(эксперты (эксперты-аудиторы))

(подпись)

Залогин Александр Сергеевич

(Ф.И.О.)

М.П. Рафалович Борис Александрович

(Ф.И.О.)

ПРИЛОЖЕНИЕ

К СЕРТИФИКАТУ СООТВЕТСТВИЯ № ЕАЭС RU C-US.AA87.B.00217/19 Лист 4

Серия **RU** № **0621347**

3.4. Электрические параметры:

3.4.1 вибропереключателей 685ухх

Напряжение питания, В 85-245 (AC), 24 (DC)
 Максимальный ток, mA 150

3.4.2 преобразователей EX(TO)(M)602yzzz/aaa, EX(TO)(M)603yzzz/aaa, EX(TO)(M)606yzzz/aaa, EX(TO)(M)607yzzz/aaa, EX(TO)(M)608yzzz/aaa, EX (XX) 622yzzz / aaa, EX (XX) 623yzzz / aaa, EX (XX) 625yzzz / aaa, EX (XX) 628yzzz / aaa

с Ex-маркировкой 2Ex nA IIC T4 Gc X:

Напряжение питания, В 28
 Максимальный ток, mA 200
 Мощность, Вт 1

3.4.3 преобразователей EX(M)637XYYYZ, (M)638XYYYZ

Напряжение питания, В 18 – 28
 Максимальный ток, mA 1,6 – 20
 Мощность, Вт 0,5

3.4.4 Предусилителей EX682XYYY

Напряжение питания, В 22 – 28
 Максимальный ток, mA 3,1 – 4,1
 Мощность, Вт 0,1

3.4.5 преобразователей EX(RV)(TO)(M)64уххх, EX(RV)(TO)(M)649уххх, EX (RV)(TO) (M)686ухх

Напряжение питания, В 18 – 30
 Максимальный ток, mA 1,6 – 20
 Мощность, Вт 0,5

4. ОПИСАНИЕ КОНСТРУКЦИИ И СРЕДСТВ ОБЕСПЕЧЕНИЯ ВЗРЫВОЗАЩИЩЕННОСТИ

Преобразователи состоят из герметичного цилиндрического металлического корпуса, в котором размещается печатная плата и пьезокристаллический элемент. Сборка подключается к разъему или встроенному кабелю. На наружной поверхности корпуса преобразователя нанесена маркировка.

Вибропереключатели серии 685ухх выполнены в металлическом корпусе, внутри которого размещена электронная плата. На наружной поверхности корпуса нанесена маркировка.

Предусилители серии EX682XYYY выполнены в прямоугольном пластиковом корпусе с креплением на DIN рейку. Внутри корпуса размещена электронная плата. На корпусе размещен съемный клеммный блок. На наружной поверхности корпуса нанесена маркировка.

Подробное описание конструкции приведено в Руководствах по эксплуатации №750119 от 23.01.19, №830119 от 23.01.19, №940219 от 07.02.19, №630119 от 22.01.19, №610119 от 22.01.19, №910219 от 07.02.19, №950219 от 08.02.19, №970219 от 08.02.19

Взрывозащищенность преобразователей, вибропереключателей и предусилителей обеспечивается выполнением требований: ГОСТ 31610.15-2012/МЭК 60079-15:2005, ГОСТ 31610.0-2014 (IEC 60079-0:2011), ГОСТ IEC 60079-1-2011, ГОСТ 31610.11-2014 (IEC 60079-11:2011), в соответствии с Ex-маркировкой.

5. МАРКИРОВКА

Маркировка, наносимая на преобразователи, вибропереключатели и предусилители, включает следующие данные:

- товарный знак или наименование предприятия-изготовителя;
- серийный номер или номер партии;
- диапазон значений температур окружающей среды при эксплуатации;
- Ex-маркировку;
- специальный знак взрывобезопасности;
- наименование центра по сертификации и номер сертификата;
- предупредительные надписи;
- искробезопасные параметры

и другие данные, которые изготовитель должен отразить в маркировке, в соответствии с требованиями нормативной и технической документации.

6. СПЕЦИАЛЬНЫЕ УСЛОВИЯ ПРИМЕНЕНИЯ

5.1 Знак X, стоящий после Ex-маркировки, означает, что при эксплуатации преобразователей, вибропереключателей, предусилителей необходимо соблюдать следующие специальные условия:

- преобразователи, вибропереключатели, предусилители должны быть подключены к сертифицированному на соответствие требованиям ТР ТС 012/2011 источнику питания с соответствующей областью применения.

5.2 Свободные концы постоянно подсоединенного кабеля должны подключаться в сертифицированной на соответствие требованиям ТР ТС 012/2011 соединительной коробке или вне взрывоопасной зоны.

Специальные условия применения, обозначенные знаком X, отражены в сопроводительной документации, подлежащей обязательной поставке в комплекте с каждым изделием.

Внесение изменений в конструкцию изделий возможно только по согласованию с ОС ЦСВЭ в соответствии с требованиями ТР ТС 012/2011.

Руководитель (уполномоченное лицо) органа по сертификации

Эксперт (эксперт-аудитор) (эксперты (эксперты-аудиторы))

(подпись)

(подпись)



Залогин Александр Сергеевич

(ф.и.о.)

М.П. Рафалович Борис Александрович

(ф.и.о.)