

TEST & MEASUREMENT SENSORS AND INSTRUMENTATION

Table of Contents

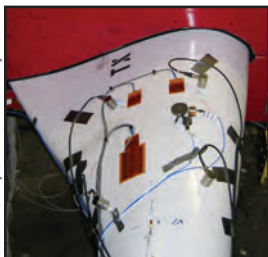
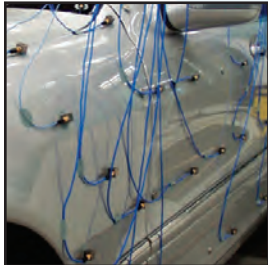
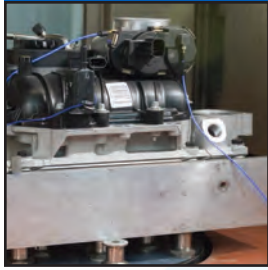

Photo Courtesy of Purdue University

Accelerometers _____	p3	Ring Configurations _____	p76
General Purpose _____	p4	Link Configurations _____	p82
Miniature _____	p10	Impact _____	p85
High Temperature ICP® (to 325 °F/163 °C) _____	p19	Strain _____	p87
High Temperature (> 500 °F/260 °C) _____	p22	Accessories _____	p89
High Sensitivity _____	p24	Load Cells _____	p91
Structural Test _____	p27	TORKDISC® _____	p100
MEMS/DC Response _____	p29	Telemetry _____	p104
Shock _____	p32	Signal Conditioners _____	p106
Accessories _____	p37	Battery / DC-Powered _____	p107
Impact Hammers & Modal Exciters _____	p42	Line-Powered _____	p109
Microphones & Preamplifiers _____	p45	Multi-Channel _____	p111
Prepolarized Condenser Microphones _____	p47	Charge Amplifiers/Converters _____	p114
Externally Polarized Condenser Microphones _____	p48	Bridge Converters _____	p119
Preamplifiers _____	p49	Cables & Accessories _____	p121
Array Style Microphones _____	p50	Calibration Services _____	p129
Acoustic Accessories _____	p51	Common Options & Custom Sensors _____	p138
Pressure Sensors _____	p53	Technical Information _____	p142
General Purpose _____	p54	Introduction to Piezoelectric Sensors _____	p142
Sub-Miniature _____	p58	Accelerometers _____	p153
Low & High Sensitivity _____	p59	Microphones _____	p157
Extreme Temperature _____	p62	Pressure Sensors _____	p160
Industrial Grade _____	p64	Force Sensors _____	p163
Static _____	p66	Strain Sensors _____	p168
Accessories _____	p68	Load Cells _____	p170
Force and Strain _____	p73	Torque Sensors _____	p172
General Purpose _____	p74		
Miniature _____	p75		

PCB PIEZOTRONICS AN AMPHENOL COMPANY

Dear Test and Measurement Professional,

Inside this catalog you will find a vast selection of sensors and sensor accessories to meet your measurement needs. This edition consolidates several of our previous product catalogs and provides enhanced technical notes to better serve you. In addition, we also offer separate catalogs for the Automotive, Aerospace & Defense, and Industrial Monitoring sectors.

With over 40 years in the sensor industry, it is our goal to continue to provide the best sensor technologies to you – the Test and Measurement professional. Our team is comprised of talented and motivated individuals, dedicated to developing the best valued sensors available. Our international offices and global network also stand ready to serve your needs in all the major technology centers around the world.

Our vision is straight forward - deliver Total Customer Satisfaction. Should you find that is not your experience with PCB, please allow us the opportunity to meet or exceed your expectations. Our customer service and application engineers are empowered to ensure all your test, measurement, or monitoring needs are met.

You can reach me at (716) 684-0001 or via email, ataggart@pcb.com with any comments or suggestions.

Sincerely,

Andy Taggart

Andy Taggart

Director of Sales & Marketing - Test & Measurement
PCB Piezotronics, Inc.



Numerical Model Number Index

Model #	Page	Model #	Page	Model #	Page	Model #	Page	Model #	Page
086 Series.....	43, 44	219A05.....	75	352C65.....	15	357A05.....	5	484 Series.....	113
101 Series.....	56, 57	221 Series.....	83	352C66.....	14	357A07.....	13	485 Series.....	108
102A05.....	59	222B.....	84	352C67.....	14	357A08.....	11	492 Series.....	120
102A07.....	59	223B.....	84	352C68.....	15	357A09.....	12	495B10-02-10.....	118
102A10.....	63	224C.....	84	353B03.....	4	357A19.....	11	498A Series.....	111, 112
102A14.....	63	225C.....	84	353B04.....	4	357B03.....	5	740B02.....	88
102B.....	57	226C.....	84	353B11.....	15	357B04.....	5	901A10.....	72
102B03.....	57	227C.....	84	353B12.....	14	357B06.....	16	903B02.....	71
102B04.....	57	231B.....	83	353B13.....	14	357B11.....	15	905C.....	72
102B06.....	56	232B.....	84	353B14.....	15	357B14.....	15	907A07.....	71
102B15.....	56	233B.....	84	353B15.....	15	357B21.....	6	913B02.....	71
102B16.....	56	234B.....	84	353B16.....	14	357B22.....	6	915A01.....	71
102B18.....	56	235B.....	84	353B17.....	14	357B33.....	6	1102 Series.....	92
103 Series.....	60	236B.....	84	353B18.....	15	357B45.....	16	1203 Series.....	93
105 Series.....	58	237B.....	84	353B31.....	6	357B53.....	23	1204 Series.....	93
106 Series.....	61	260 Series.....	81	353B32.....	6	357B54.....	23	1380 Series.....	98
108 Series.....	64	261 Series.....	82	353B33.....	6	357B61.....	23	1381 Series.....	98
138 Series.....	54, 55	288D01.....	35	353B34.....	6	357B69.....	23	1403 Series.....	94
112 Series.....	59	300A12.....	21	353B77.....	14	357C10.....	12	1404 Series.....	95
113 Series.....	54, 55	320 Series.....	20, 21	354C02.....	8	357C90.....	23	1408 Series.....	95
116 Series.....	63	333 Series.....	28	354C03.....	8	357M50.....	21	1411 Series.....	95
118 Series.....	64	339 Series.....	21	354C10.....	18	377 Series.....	46, 51	1501 Series.....	66
121 Series.....	65	340A50.....	9	355B02.....	5	378 Series.....	49	1502 Series.....	66
130 Series.....	50	350 Series.....	33, 34	355B03.....	5	393 Series.....	25, 26	1503 Series.....	66
132 Series.....	67	352A21.....	12	355B04.....	25	394A10.....	35	1621-02A.....	97
134 Series.....	67	352A24.....	13	355B12.....	16	394A11.....	35	1630 Series.....	96
137 Series.....	67	352A25.....	12	355B33.....	5	394A40.....	52	1631 Series.....	97
138 Series.....	67	352A56.....	13	355B34.....	5	394C06.....	35	2520.....	47
200 Series.....	85, 86	352A60.....	4	356A01.....	17	401B04.....	120	2540.....	47
201 Series.....	76	352A71.....	12	356A02.....	7	410B01.....	113	2541.....	47
202B.....	77	352A72.....	12	356A12.....	18	421 Series.....	117	2559.....	47
203B.....	77	352A73.....	11	356A13.....	17	422E Series.....	115, 116	2560.....	47
204C.....	77	352B.....	25	356A14.....	7	422M136.....	21	2570.....	47
205C.....	77	352B01.....	13	356A15.....	7	422M182.....	118	2575.....	47
206C.....	77	352B10.....	13	356A16.....	8	422M183.....	118	3711 Series.....	30
207C.....	77	352B70.....	4	356A17.....	8	426 Series.....	49, 51	3713 Series.....	30
208 Series.....	74	352C03.....	4	356A24.....	17	427 Series.....	119	3741 Series.....	30
209 Series.....	75	352C04.....	4	356A25.....	7	442 Series.....	113, 114	5300 Series.....	101
211B.....	78	352C22.....	12	356A26.....	7	443 Series.....	114	8159 Series.....	99
212B.....	78	352C23.....	11	356A30.....	18	445C01.....	31	8161 Series.....	99
213B.....	78	352C33.....	4	356A31.....	18	478 Series.....	31	8179 Series.....	105
214B.....	78	352C34.....	4	356A32.....	18	480 Series.....	107	8180 Series.....	105
215B.....	79	352C41.....	16	356A33.....	18	481A Series.....	112	8182 Series.....	99
216B.....	79	352C42.....	16	356A34.....	18	481A20.....	67	CAL200.....	52
217B.....	79	352C43.....	16	356A35.....	18	482A18.....	111	CAL250.....	52
218 Series.....	74	352C44.....	16	356A36.....	18	482A20.....	111	HVM-100.....	36
				356A61.....	17	482A21.....	67, 109	RHM240 Series.....	88
				356A63.....	18	482B11.....	109	VibTrack HaV.....	36
				356A66.....	7	482C05.....	67, 109		
				356A70.....	9	482C15.....	109		
				356A71.....	9	482C16.....	110		
				356B10.....	17	482C26.....	110		
				356B11.....	17	482C27.....	31		
				356B18.....	8	482C54.....	110		
				356B20.....	17	482C64.....	110		
				356B21.....	17	483 Series.....	111		
				356B41.....	36	483C05.....	67, 111		



General Purpose Piezoelectric Accelerometers

Applications

- Product Qualification Studies
- Vibration Control
- Impulse Response Measurements
- Quality Assurance (End of Line Testing)
- Machinery Studies

Piezoelectric accelerometers offer tremendous versatility for shock and vibration measurements. These rugged sensors can withstand adverse environmental conditions. A wide variety of configurations are available to support multiple application requirements. Specialty units are also available through mechanical or electrical design adjustments or additional qualification testing.

There are two broad categories for piezoelectric accelerometers – those that contain built-in signal conditioning electronics (ICP[®] type) and those that do not (Charge Output type). Generally, ICP[®] accelerometers are preferred, due to ease of use and lower system cost. Charge Output accelerometers are used for high temperature environments, which would otherwise destroy the electrical components contained in an ICP[®] type.

Triaxial accelerometers offer simultaneous measurements in three orthogonal directions permitting the entire vibration being experienced by a structure to be analyzed. Each unit incorporates three separate sensing elements that are oriented at right angles with respect to each other. Multi-pin electrical connectors, individual cable leads, or multiple coaxial connectors provide the signal outputs for the x, y, and z-axis acceleration.

The use of triaxial accelerometers has gained popularity since the desire for in-depth structural vibration analysis has increased and multi-channel data acquisition costs have declined. These devices are vital tools for structural analysis testing requirements.



Photo Courtesy of Clemson University

General Purpose Single Axis Accelerometers

Motion of a rigid body can be characterized within six degrees of freedom. Providing mechanical excitation to simulate all of this motion as may be encountered in the real world can entail a variety of test machines. Regardless of the apparatus, the goal is always to ensure that the product under test can adequately perform, and reliably survive, in the environment in which it will be deployed, or to which it will be exposed during transport. PCB[®] accelerometers provide the measurement signals needed to control the vibratory input and to analyze the product's reaction to such testing. Did the test achieve the acceleration amplitudes and frequencies desired? Did the product react in a consistent manner? Did any components or mounting techniques become altered? These are just a few of the questions that can be verified by analyzing the signals generated by PCB[®] accelerometers.



Photo Courtesy of Dayton T. Brown, Inc.

General Purpose Single Axis Accelerometers

Photos Shown Actual Size					
Model Number	352B70	352A60	352C04	352C33	353B03
Sensitivity	1 mV/g	10 mV/g	10 mV/g	100 mV/g	10 mV/g
Measurement Range	± 5000 g pk	± 500 g pk	± 500 g pk	± 50 g pk	± 500 g pk
Broadband Resolution	0.025 g rms	0.002 g rms	0.0005 g rms	0.00015 g rms	0.003 g rms
Frequency Range (± 5%)	0.7 to 9k Hz	5.0 to 60k Hz [1]	0.5 to 10k Hz	0.5 to 10k Hz	1 to 7k Hz
Resonant Frequency	≥ 55 kHz	≥ 95 kHz	≥ 50 kHz	≥ 50 kHz	≥ 38 kHz
Temperature Range	-65 to +250 °F -54 to +121 °C	-65 to +250 °F -54 to +121 °C	-65 to +250 °F -54 to +121 °C	-65 to +200 °F -54 to +93 °C	-65 to +250 °F -54 to +121 °C
Sensing Element	Ceramic/Shear	Ceramic/Shear	Ceramic/Shear	Ceramic/Shear	Quartz/Shear
Electrical Connector	10-32 Coaxial Jack	5-44 Coaxial Jack	10-32 Coaxial Jack	10-32 Coaxial Jack	10-32 Coaxial Jack
Electrical Ground Isolation	Yes	No	No	No	No
Housing Material	Titanium	Stainless Steel	Titanium	Titanium	Titanium
Sealing	Hermetic	Hermetic	Hermetic	Hermetic	Hermetic
Weight	4.3 gm	6.0 gm	5.8 gm	5.8 gm	10.5 gm
Size	3/8 x 0.90 in 3/8 in x 22.9 mm	3/8 x 0.81 in 3/8 in x 21.6 mm	7/16 x 0.88 in 7/16 in x 22.4 mm	7/16 x 0.62 in 7/16 in x 15.7 mm	1/2 x 0.81 in 1/2 in x 20.6 mm
Mounting	10-32 Thread	10-32 Stud	10-32 Thread	10-32 Thread	10-32 Thread
Supplied Accessories					
Wax	—	—	080A109	080A109	080A109
Adhesive Mounting Base	080A04	—	080A	080A	080A
Mounting Stud/Screw	081B05, M081B05	—	081B05, M081B05	081B05, M081B05	081B05, M081B05
Additional Versions					
Metric Mounting Thread	—	M352A60	—	—	—
Alternate Connector Position	—	—	352C03-Side	352C34-Top	353B04-Top
Additional Accessories					
Magnetic Mounting Base	080A27	080A179	080A27	080A27	080A27
Triaxial Mounting Adaptor	080A17	080A17	080B10	080B10	080B10
Mating Cable Connector	EB	AG	EB	EB	EB
Recommended Cables	002, 003 CE	018 Flexible, 003 CE	002, 003 CE	002, 003 CE	002, 003 CE
Note					
[1] Frequency range ±3dB					

General Purpose Single Axis Accelerometers

Why select accelerometers with a through hole configuration?







The main advantage of a Through Hole configuration is the control over the orientation of the electrical connector and mating cable assembly. This can be essential when a screw mount is required in a confined location.

In addition, all PCB® Through Hole units include an off-ground isolation base and cap screw, which provides electrical ground isolation on a conductive test structure.

Applications:

- Routine Vibration Testing
- Product Testing
- Structural Testing
- Vibration Control
- Package Drop Testing

General Purpose Single Axis Accelerometers

Photos Shown Actual Size						
Model Number	357B03	355B02	355B03	357A05	355B34	355B33
Sensitivity	10 pC/g	10 mV/g	100 mV/g	17 pC/g	10 mV/g	100 mV/g
Measurement Range	± 2000 g pk	±500 g pk	±50 g pk	± 500 g pk	± 500 g pk	± 50 g pk
Broadband Resolution	[1]	0.0005 g rms	0.0001 g rms	[1]	0.001 g rms	0.0005 g rms
Frequency Range (± 5%)	9 kHz [2]	1 to 10k Hz	1 to 10k Hz	10k Hz [2]	2 to 5k Hz	2 to 5k Hz
Resonant Frequency	≥ 38 kHz	≥ 35 kHz	≥ 35 kHz	≥ 35 kHz	≥ 25 kHz	≥ 25 kHz
Temperature Range	-95 to +500 °F -71 to +260 °C	-65 to +250 °F -54 to +121 °C	-65 to +250 °F -54 to +121 °C	-65 to +350 °F -54 to +177 °C	-65 to +250 °F -54 to +121 °C	-65 to +250 °F -54 to +121 °C
Sensing Element	Ceramic/Shear	Ceramic/Shear	Ceramic/Shear	Ceramic/Shear	Quartz/Shear	Quartz/Shear
Electrical Connector	10-32 Coaxial Jack	10-32 Coaxial Jack	10-32 Coaxial Jack	10-32 Coaxial Jack	10-32 Coaxial Jack	10-32 Coaxial Jack
Electrical Ground Isolation	No	Yes	Yes	Yes	Yes	Yes
Housing Material	Titanium	Titanium	Titanium	Titanium	Titanium	Titanium
Sealing	Hermetic	Hermetic	Hermetic	Hermetic	Hermetic	Hermetic
Weight	11 gm	10 gm	10 gm	10 gm	11 gm	11 gm
Size	1/2 x 0.81 in 1/2 in x 20.6 mm	0.40 x 0.95 x 0.63 in 10.2 x 24.1 x 16.0 mm	0.95 x 0.63 in 24. x 16.0 mm	0.4 x 0.95 x 0.63 in 10.2 x 24.1 x 16 mm	0.40 x 0.70 x 0.63 in 10.2 x 17.8 x 15.9 mm	0.40 x 0.70 x 0.63 in 10.2 x 17.8 x 15.9 mm
Mounting	10-32 Thread	Through Hole	Through Hole	Through Hole	Through Hole	Through Hole
Supplied Accessories						
Wax	080A109	080A109	080A109	080A109	080A109	080A109
Mounting Stud/Screw	081B05, M081B05	081B45	081B45	081B45	081B45	081B45
Additional Versions						
Metric Mounting Thread	—	M355B02	M355B03	M357A05	M355B34	M355B33
Alternate Connector Position	357B04-Top	—	—	—	—	—
Additional Accessories						
Adhesive Mounting Base	080A	—	—	—	—	—
Magnetic Mounting Base	080A27	—	—	—	—	—
Triaxial Mounting Adaptor	080B10	—	—	—	—	—
Mating Cable Connector	EB	EB	EB	EB	EB	EB
Recommended Cables	003 CE	002, 003 CE	002, 003 CE	003 CE	002, 003 CE	002, 003 CE
Note						
[1] Resolution is dependent upon cable length and signal conditioner [2] Low frequency response determined by external electronics						

General Purpose Single Axis Accelerometers

Packaging a product for safe transport is essential to ensure its survival from the factory to the end-user. A good package design requires testing to determine its effectiveness at restraining or cushioning the product from transport and accidental forces. PCB® accelerometers are instrumental in measuring both the impact and vibration experienced by the outer container and the product. The difference between these measurements provides useful data for quantifying the effectiveness of the packaging materials and the package design.

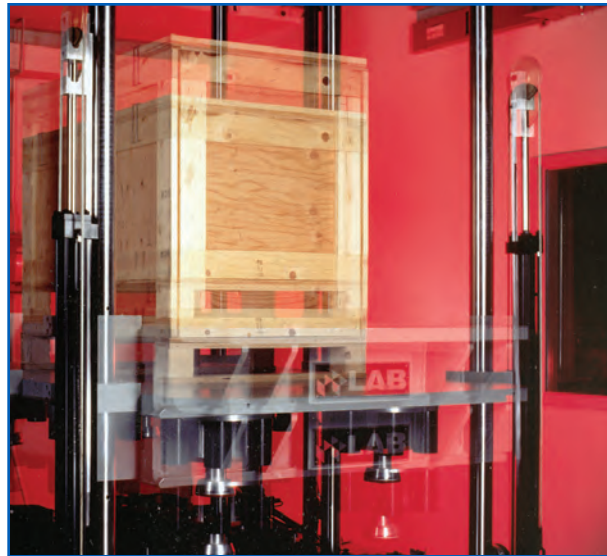





Photo Courtesy of Sun Microsystems Advanced Product Testing Laboratory

General Purpose Single Axis Accelerometers

				
Model Number	353B31	357B22	353B33	357B33
Sensitivity	50 mV/g	30 pC/g	100 mV/g	100 pC/g
Measurement Range	± 100 g pk	± 1500 g pk	± 50 g pk	± 150 g pk
Broadband Resolution	0.001 g rms	[1]	0.0005 g rms	[1]
Frequency Range (± 5%)	1 to 5k Hz	6 kHz [2]	1 to 4k Hz	3 kHz [2]
Resonant Frequency	≥ 30 kHz	≥ 23 kHz	≥ 22 kHz	≥ 13 kHz
Temperature Range	-65 to +250 °F -54 to +121 °C	-95 to +500 °F -71 to +260 °C	-65 to +250 °F -54 to +121 °C	-95 to +500 °F -71 to +260 °C
Sensing Element	Quartz/Shear	Ceramic/Shear	Quartz/Shear	Ceramic/Shear
Electrical Connector	10-32 Coaxial Jack	10-32 Coaxial Jack	10-32 Coaxial Jack	10-32 Coaxial Jack
Electrical Ground Isolation	No	No	No	No
Housing Material	Titanium	Titanium	Titanium	Titanium
Sealing	Hermetic	Hermetic	Hermetic	Hermetic
Weight	20 gm	21 gm	27 gm	45 gm
Size	3/4 x 0.85 in 3/4 in x 21.6 mm	5/8 x 1.16 in 5/8 in x 29.3 mm	3/4 x 0.93 in 3/4 in x 23.6 mm	3/4 x 1.00 in 3/4 in x 25.4 mm
Mounting	10-32 Thread	10-32 Thread	10-32 Thread	10-32 Thread
Supplied Accessories				
Wax/Adhesive	080A109	080A109	080A109	080A109
Adhesive Mounting Base	080A12	—	080A12	—
Mounting Stud/Screw	081B05, M081B05	081B05, M081B05	081B05, M081B05	081B05, M081B05
Additional Version				
Alternate Connector Position	353B32-Top	357B21-Side	353B34-Top	—
Additional Accessories				
Adhesive Mounting Base	—	080A12	—	080A12
Magnetic Mounting Base	080A27	080A27	080A27	080A27
Triaxial Mounting Adaptor	080B11	080B11	080B11	080B11
Mating Cable Connector	EB	EB	EB	EB
Recommended Cables	002, 003 CE	003 CE	002, 003 CE	003 CE
Note				
[1] Resolution is dependent upon cable length and signal conditioner [2] Low frequency response determined by external electronics				

General Purpose Triaxial Accelerometers



Photos Courtesy of Clemson University

General Purpose Triaxial Accelerometers

<p>Photos Shown Actual Size</p>				
	356A02	356A25	356A26	356A15
Sensitivity	10 mV/g	25 mV/g	50 mV/g	100 mV/g
Measurement Range	± 500 g pk	± 200 g pk	± 100 g pk	± 50 g pk
Broadband Resolution	0.0005 g rms	0.0002 grms	0.0002 grms	0.0002 g rms
Frequency Range (± 5%)	1 to 5k Hz	1 to 5k Hz	1 to 5k Hz	2 to 5k Hz
Resonant Frequency	≥ 25 kHz	≥ 25 kHz	≥ 25 kHz	≥ 25 kHz
Temperature Range	-65 to +250 °F -54 to +121 °C	-65 to +250 °F -54 to +121 °C	-65 to +250 °F -54 to +121 °C	-65 to +250 °F -54 to +121 °C
Sensing Element	Ceramic/Shear	Ceramic/Shear	Ceramic/Shear	Ceramic/Shear
Electrical Connector	1/4-28 4-Pin Jack	1/4-28 4-Pin Jack	1/4-28 4-Pin Jack	1/4-28 4-Pin Jack
Electrical Ground Isolation	No	No	No	No
Housing Material	Titanium	Titanium	Titanium	Titanium
Sealing	Hermetic	Hermetic	Hermetic	Hermetic
Weight	10.5 gm	10.5 gm	10.5 gm	10.5 gm
Size	0.55 in Cube 14 mm Cube	0.55 in Cube 14 mm Cube	0.55 in Cube 14 mm Cube	0.55 in Cube 14 mm Cube
Mounting	10-32 Thread	10-32 Thread	10-32 Thread	10-32 Thread
Supplied Accessories				
Cable	—	—	—	—
Wax/Adhesive	080A109/080A90	080A109	080A109/080A90	080A109/080A90
Adhesive Mounting Base	080A12	080A12	080A12	080A12
Mounting Stud/Screw	081B05, M081B05	081B05, M081B05	081B05, M081B05	081B05, M081B05
Additional Versions				
Built-in Low Pass Filter	356A66	—	—	—
Extended Low Frequency	—	—	—	356A14
Additional Accessories				
Magnetic Mounting Base	080A27	080A27	080A27	080A27
Removal Tool	039A10	039A10	039A10	039A10
Mating Cable Connector	AY	AY	AY	AY
Recommended Cable	034	034	034	034
Note				
[1] Frequency range ±1dB				

General Purpose Triaxial Accelerometers

Applications:

- Modal Analysis
- Micro Machining
- Motors & Pumps
- Vibration Isolation



General Purpose Triaxial Accelerometers

					
Photos Shown Actual Size					
Model Number	356A16	356A17	354C02	354C03	356B18
Sensitivity	100 mV/g	500 mV/g	10 mV/g	100 mV/g	1000 mV/g
Measurement Range	± 50 g pk	± 10 g pk	± 500 g pk	± 50 g pk	± 5 g pk
Broadband Resolution	0.0001 g rms	0.00006 g rms	0.0005 g rms	0.0002 g rms	0.00005 g rms
Frequency Range (± 5%)	0.5 to 4.5k Hz	0.5 to 3k Hz	0.5 to 2k Hz	0.5 to 2k Hz	0.5 to 3k Hz
Resonant Frequency	≥ 25 kHz	≥ 14 kHz	≥ 12 kHz	≥ 12 kHz	≥ 20 kHz
Temperature Range	-65 to +176 °F -54 to +80 °C	-65 to +176 °F -54 to +80 °C	-65 to +250 °F -54 to +121 °C	-65 to +250 °F -54 to +121 °C	-20 to +170 °F -29 to +77 °C
Sensing Element	Ceramic/Shear	Ceramic/Shear	Ceramic/Shear	Ceramic/Shear	Ceramic/Shear
Electrical Connector	1/4-28 4-Pin Jack	1/4-28 4-Pin Jack	1/4-28 4-Pin Jack	1/4-28 4-Pin Jack	1/4-28 4-Pin Jack
Electrical Ground Isolation	No	No	Yes	Yes	No
Housing Material	Anodized Aluminum	Anodized Aluminum	Titanium	Titanium	Anodized Aluminum
Sealing	Epoxy	Epoxy	Hermetic	Hermetic	Epoxy
Weight	7.4 gm	9.3 gm	15.5 gm	15.5 gm	25 gm
Size	0.55 in Cube 14 mm Cube	0.55 in Cube 14 mm Cube	13/16 x 0.45 in 13/16 in x 11.4 mm	13/16 x 0.45 in 13/16 in x 11.4 mm	0.8 in Cube 20.3 mm Cube
Mounting	10-32 Thread	5-40 Thread	Through Hole	Through Hole	10-32 Thread
Supplied Accessories					
Wax	080A109	080A109	080A109	080A109	080A109
Adhesive Mounting Base	080A12	080A145	—	—	080A68
Mounting Stud/Screw	081B05, M081B05	081A27, M081A27	081B60	081B60	081B05, M081B05
Additional Version					
Metric Mounting Thread	—	—	M354C02	M354C03	—
Additional Accessories					
Magnetic Mounting Base	080A27	—	080M162	080M162	080A27
Removal Tool	039A10	039A10	—	—	—
Mating Cable Connector	AY	AY	AY	AY	AY
Recommended Cable	034	034	034	034	034

General Purpose Triaxial Accelerometers

Photo Courtesy of Spectrum Technologies

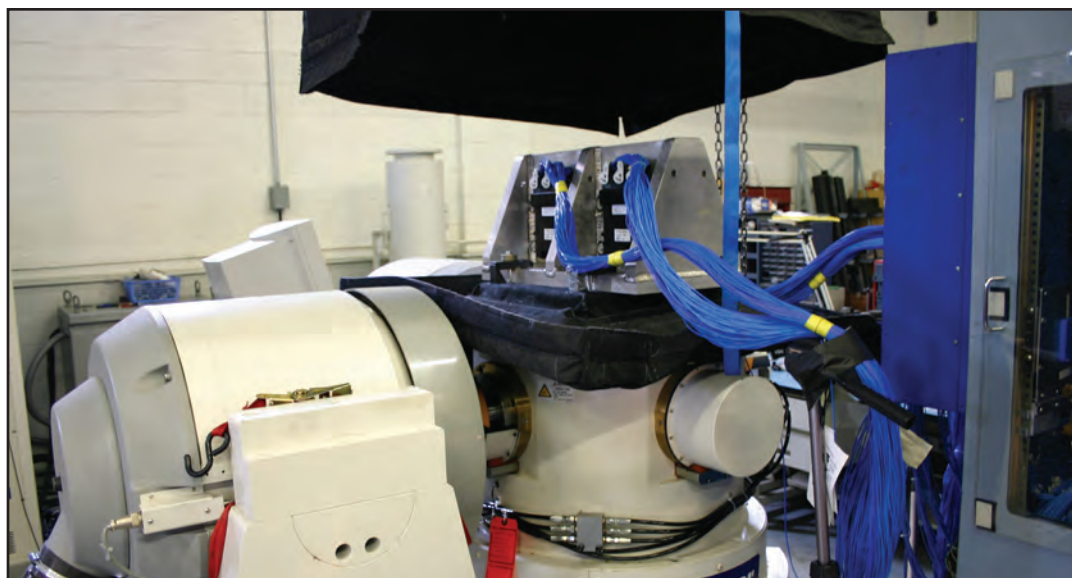

General Purpose Triaxial Accelerometers

			
Photos Shown 3/4 Size			
Model Number	356A70	340A50	356A71
Sensitivity	2.7 pC/g	2.7 pC/g	10 pC/g
Measurement Range	± 500 g pk	± 1000 g pk	± 500 g pk
Broadband Resolution	[1]	[1]	[1]
Frequency Range (± 5%)	5 kHz [2]	8 kHz [2]	5 kHz [2]
Resonant Frequency	≥ 35 kHz	≥ 25 kHz	≥ 25 kHz
Temperature Range	-94 to +490 °F -70 to +254 °C	-94 to +500 °F -70 to +260 °C	-95 to +490 °F -70 to +254 °C
Sensing Element	Ceramic/Shear	Ceramic/Shear	Ceramic/Shear
Electrical Connector	5-44 Coaxial Jack	M3 Coaxial Jack	10-32 Coaxial Jack
Electrical Ground Isolation	No	No	No
Housing Material	Titanium	Titanium	Titanium
Sealing	Hermetic	Hermetic	Hermetic
Weight	7.9 gm	11.0 gm	22.7 gm
Size	0.4 x 0.73 x 0.9 in 10.2 x 18.5 x 22.9 mm	0.4 x 0.85 x 0.5 in 10.2 x 21.6 x 12.7 mm	0.5 x 0.96 x 1.0 in 12.7 x 24.4 x 25.4 mm
Mounting	Through Hole	Through Hole	Through Hole
Supplied Accessories			
Wax/Adhesive	080A90	080A109/080A90	080A90
Adhesive Mounting Base	—	080A147	080A170
Mounting Stud/Screw	081A46	081A95	081A94
Additional Version			
Metric Mounting Thread	M356A70	—	M356A71
Additional Accessories			
Mating Cable Connectors	AF, AG	EP	EB
Recommended Cables	003	003	003
Notes			
[1] Resolution is dependent upon cable length and signal conditioner [2] Low frequency response determined by external electronics			

Miniature Piezoelectric Accelerometers



Highlights

- No moving parts provides durability
- Rigidity imparts high frequency range
- Lightweight construction minimizes mass loading
- Numerous configuration options
- Mount by screw, stud, or adhesive
- Available with both Quartz elements (for thermal stability) or Ceramic elements (for high measurement resolution)

Applications

- Drop Testing & Package Testing
- Small Component Qualification Testing
- Low Amplitude Vibration Measurements
- High Frequency Applications
- Space Restricted Installations

Structured with highly sensitive piezoceramic sensing elements, Ceramic Shear ICP[®] Accelerometers have an excellent signal-to-noise ratio, high measurement resolution, and are ideal for conducting low-level vibration measurements. Due to their inherent higher sensitivity, a ceramic ICP[®] accelerometer can be assembled with a smaller mass than comparable quartz units, resulting in a sensor that is lighter in weight, has a higher frequency response, and has a lower noise floor.

To further reduce the mass of the sensors, all ceramic shear accelerometers are housed in either tough, lightweight, laser-welded, hermetically sealed, titanium or aluminum housings. By minimizing the mass of the sensor, mass loading effects are reduced, which maximizes the accuracy of the data obtained.

Charge Output miniature accelerometers are capable of operation to +500 °F (+260 °C), permitting measurements in extreme environments and with existing charge amplified systems.

Triaxial accelerometers are available in a variety of sensitivities to suit specific application requirements. Choose miniature, lightweight units for high-frequency response, minimized mass loading, and when installation is in space restricted locations. Low profile designs are ideal for on-road or wind tunnel testing of exterior body panels. Through-hole mount units simplify axis and electrical connector orientation while controlling cable routing along the test specimen. Filtered output units avoid high frequency overload as may be encountered with engine NVH and drive train measurements.

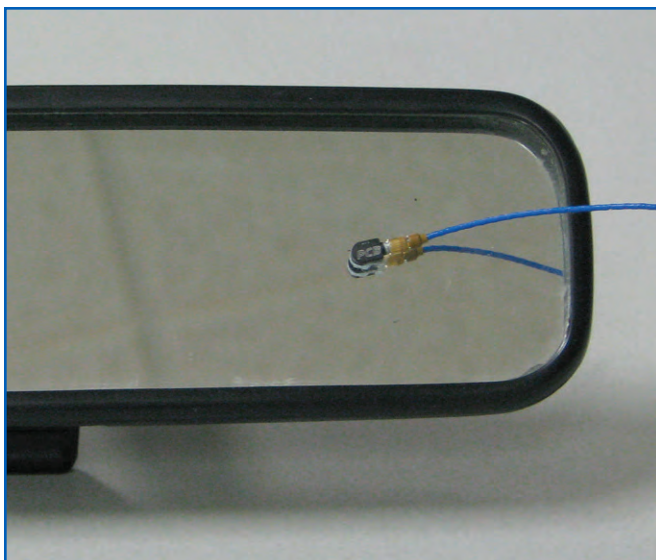



Miniature Single Axis Accelerometers

Miniature piezoelectric accelerometers are required for applications demanding high frequency range, small size, and low weight.

Applications:

- Environmental Testing
- Component Qualification
- Structural Testing
- Operational Behavior Studies
- Fatigue Testing
- Vibration & Sound Cancellation

Miniature Single Axis Accelerometers			
Photos Shown Actual Size		CE 	
Model Number	357A08	352C23	352A73
Sensitivity	0.35 pC/g	5 mV/g	5 mV/g
Measurement Range	± 1000 g pk	± 1000 g pk	± 1000 g pk
Broadband Resolution	[1]	0.003 g rms	0.002 g rms
Frequency Range (± 5%)	12 kHz [2]	2 to 10k Hz	2 to 10k Hz
Resonant Frequency	≥ 70 kHz	≥ 70 kHz	≥ 70 kHz
Temperature Range	-100 to +350 °F -73 to +177 °C	-65 to +250 °F -54 to +121 °C	-65 to +250 °F -54 to +121 °C
Sensing Element	Ceramic/Shear	Ceramic/Shear	Ceramic/Shear
Electrical Connector	3-56 Coaxial Jack	3-56 Coaxial Jack	Integral Cable
Electrical Ground Isolation	Yes	Yes	No
Housing Material	Anodized Aluminum	Anodized Aluminum	Titanium
Sealing	Epoxy	Epoxy	Hermetic
Weight	0.16 gm	0.2 gm	0.3 gm
Size	0.11 x 0.16 x 0.27 in 2.8 x 4.1 x 6.9 mm	0.11 x 0.34 x 0.16 in 2.8 x 8.6 x 4.1 mm	0.11 x 0.34 x 0.16 in 2.8 x 8.6 x 4.1 mm
Mounting	Adhesive	Adhesive	Adhesive
Supplied Accessories			
Cable	030A10	030A10	—
Wax	080A109	080A109	080A109
Removal Tool	039A29	039A26	039A26
Additional Version			
Titanium Housing	357A19	—	—
Additional Accessories			
Triaxial Mounting Adaptor	080A194	080A194	080A194
Connector Adaptor	070A02	070A02	070A02
Mating Cable Connector	EK	EK	AL
Recommended Cable	030	030	—
Note			
[1] Resolution is dependent upon cable length and signal conditioner [2] Low frequency response determined by external electronics			

Miniature Single Axis Accelerometers

Tips from Techs

Should my mini accelerometer be titanium or aluminum?





PCB® offers miniature “Teardrop” accelerometers in both titanium and aluminum. Titanium has the benefit of being a stronger base material, making it more robust for repeated installations & removals. The advantages of aluminum include a slightly lower mass, and an anodized finish to provide electrical isolation.

With either material it is essential to use the removal tool supplied with each sensor along with the appropriate de-bonding agent.

Photo Courtesy of Clemson University



Miniature Single Axis Accelerometers

				
Photos Shown Actual Size				
Model Number	352A25	352C22	357C10	352A71
Sensitivity	2.5 mV/g	10 mV/g	1.7 pC/g	10 mV/g
Measurement Range	± 2000 g pk	± 500 g pk	± 500 g pk	± 500 g pk
Broadband Resolution	0.01 g rms	0.002 g rms	[1]	0.003 g rms
Frequency Range (± 5%)	1 to 10k Hz	1 to 10k Hz	10 kHz [2]	0.5 to 10k Hz
Resonant Frequency	≥ 80 kHz	≥ 50 kHz	≥ 50 kHz	≥ 65 kHz
Temperature Range	-65 to +250 °F -54 to +121 °C	-65 to +250 °F -54 to +121 °C	-100 to +350 °F -73 to +177 °C	-65 to +250 °F -54 to +121 °C
Sensing Element	Ceramic/Shear	Ceramic/Shear	Ceramic/Shear	Ceramic/Shear
Electrical Connector	3-56 Coaxial Jack	3-56 Coaxial Jack	3-56 Coaxial Jack	Integral Cable
Electrical Ground Isolation	No	Yes	Yes	No
Housing Material	Titanium	Anodized Aluminum	Anodized Aluminum	Titanium
Sealing	Epoxy	Epoxy	Epoxy	Hermetic
Weight	0.6 gm	0.5 gm	0.5 gm	0.6 gm
Size	0.14 x 0.45 x 0.25 in 3.6 x 11.4 x 6.4 mm	0.14 x 0.45 x 0.25 in 3.6 x 11.4 x 6.4 mm	0.14 x 0.45 x 0.25 in 3.6 x 11.4 x 6.4 mm	0.14 x 0.41 x 0.25 in 3.6 x 10.4 x 6.4 mm
Mounting	Adhesive	Adhesive	Adhesive	Adhesive
Supplied Accessories				
Cable	030A10	030A10	030A10	—
Wax	080A109	080A109	080A109	080A109
Removal Tool	039A27	039A27	039A27	039A32
Additional Versions				
Built-in Low Pass Filter	—	—	—	352A72
Titanium Housing	—	352A21	357A09	—
Additional Accessories				
Connector Adaptor	070A02	070A02	070A02	070A02
Mating Cable Connector	EK	EK	EK	AL
Recommended Cable	030	030	030	—
Note				
[1] Resolution is dependent upon cable length and signal conditioner [2] Low frequency response determined by external electronics				

Miniature Single Axis Accelerometers

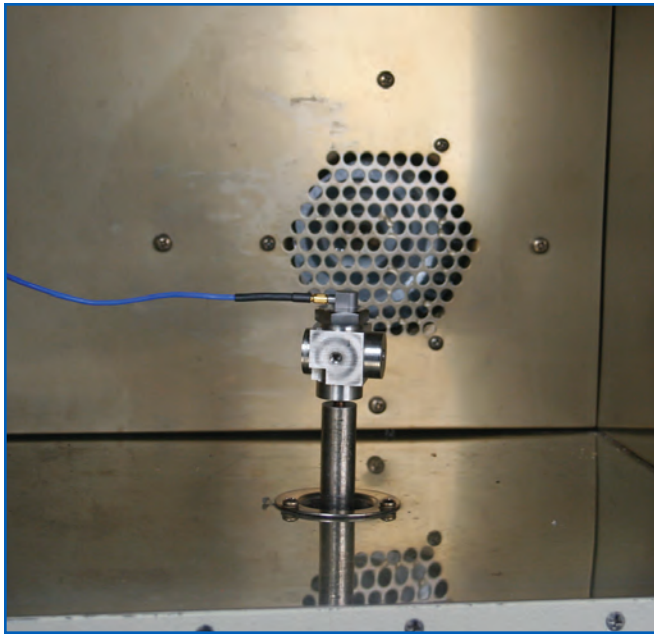

Applications:

- Circuit Boards
- Components
- Small Assemblies



Miniature Single Axis Accelerometers

Model Number	352B01	352B10	352A24	357A07	352A56 [1]
Sensitivity	1 mV/g	10 mV/g	100 mV/g	1.7 pC/g	100 mV/g
Measurement Range	± 5000 g pk	± 500 g pk	± 50 g pk	± 2000 g pk	± 50 g pk
Broadband Resolution	0.02 g rms	0.003 g rms	0.0002 g rms	[2]	0.0006 g rms
Frequency Range (± 5%)	2 to 10k Hz	2 to 10k Hz	2 to 8k Hz	15 kHz [3]	0.5 to 10k Hz
Resonant Frequency	≥ 65 kHz	≥ 65 kHz	≥ 30 kHz	≥ 60 kHz	≥ 45 kHz
Temperature Range	-65 to +250 °F -54 to +121 °C	-65 to +250 °F -54 to +121 °C	-65 to +250 °F -54 to +121 °C	-100 to +500 °F -73 to +260 °C	-65 to +250 °F -54 to +121 °C
Sensing Element	Ceramic/Shear	Ceramic/Shear	Ceramic/Shear	Ceramic/Shear	Ceramic/Shear
Electrical Connector	Integral Cable	Integral Cable	3-56 Coaxial Jack	M3 Coaxial Jack	5-44 Coaxial Jack
Electrical Ground Isolation	No	No	Yes	No	No
Housing Material	Titanium	Titanium	Anodized Aluminum	Titanium	Titanium
Sealing	Hermetic	Hermetic	Epoxy	Hermetic	Hermetic
Weight	0.7 gm	0.7 gm	0.8 gm	1.0 gm	1.8 gm
Size	0.32 x 0.24 in 8.1 x 6.1 mm	0.32 x 0.24 in 8.1 x 6.1 mm	0.19 x 0.48 x 0.28 in 4.8 x 12.2 x 7.1 mm	0.195 x 0.42 x 0.25 in 4.9 x 10.7 x 6.4 mm	0.26 x 0.57 x 0.3 in 6.6 x 14.5 x 7.6 mm
Mounting	Adhesive	Adhesive	Adhesive	Adhesive	Adhesive
Supplied Accessories					
Cable	—	—	030A10	030B10	—
Wax/Adhesive	080A109/080A90	080A109/080A90	080A109	080A109	080A109
Removal Tool	—	—	039A28	039A28	039A31
Additional Accessories					
Connector Adaptor	070A02	070A02	070A02	070A02	—
Mating Cable Connector	AL	AL	EK	EP	AG
Recommended Cables	—	—	030	030	018 Flexible, 003 CE
Notes					
[1] Incorporates TEDS per IEEE P1451.4 [2] Resolution is dependent upon cable length and signal conditioner [3] Low frequency response determined by external electronics					

Miniature Single Axis Accelerometers

In competitive sports, the slightest advantage can make the difference between winning and losing. Biomechanical studies can be helpful in gaining an understanding of overall capabilities, fine-tuning physical techniques for optimal performance, as well as determining healing progress and effectiveness after an injury. PCB® accelerometers have been used to satisfy a multitude of measurement requirements including product testing, design validation, structural analysis, and even animal behavior.



Miniature Single Axis Accelerometers				
Photos Shown Actual Size				
	353B16	352C66	353B17	352C67
Sensitivity	10 mV/g	100 mV/g	10 mV/g	100 mV/g
Measurement Range	± 500 g pk	± 50 g pk	± 500 g pk	± 50 g pk
Broadband Resolution	0.005 g rms	0.00016 g rms	0.005 g rms	0.00016 g rms
Frequency Range (± 5%)	1 to 10k Hz	1 to 10k Hz	1 to 10k Hz	5 to 10k Hz
Resonant Frequency	≥ 70 kHz	≥ 35 kHz	≥ 70 kHz	≥ 35 kHz
Temperature Range	-65 to +250 °F -54 to +121 °C	-65 to +200 °F -54 to +93 °C	-65 to +250 °F -54 to +121 °C	-65 to +200 °F -54 to +93 °C
Sensing Element	Quartz/Shear	Ceramic/Shear	Quartz/Shear	Ceramic/Shear
Electrical Connector	5-44 Coaxial Jack	5-44 Coaxial Jack	Integral Cable	Integral Cable
Electrical Ground Isolation	No	No	No	No
Housing Material	Titanium	Titanium	Titanium	Titanium
Sealing	Hermetic	Hermetic	Hermetic	Hermetic
Weight	1.5 gm	2.0 gm	1.7 gm	2.0 gm
Size	9/32 x 0.67 in 9/32 in x 17 mm	9/32 x 0.67 in 9/32 in x 17 mm	9/32 x 0.59 in 9/32 in x 14.9 mm	9/32 x 0.55 in 9/32 in x 13.9 mm
Mounting	5-40 Stud	5-40 Stud	5-40 Stud	5-40 Stud
Supplied Accessories				
Wax	080A109	080A109	080A109	080A109
Adhesive Mounting Base	080A15	080A15	080A15	080A15
Additional Versions				
Metric Mounting Thread	M353B16	M352C66	M353B17	M352C67
Alternative Sensitivity	(M)353B12 - 5 mV/g	—	(M)353B77 - 2 mV/g (M)353B13 - 5 mV/g	—
Additional Accessories				
Magnetic Mounting Base	080A30	080A30	080A30	080A30
Triaxial Mounting Adaptor	080B16, 080A196	080B16, 080A196	080B16, 080A196	080B16, 080A196
Mating Cable Connector	AG	AG	AL	AL
Recommended Cables	018 Flexible, 003 CE	018 Flexible, 003 CE	—	—
Connector Adaptor	—	—	070A02	070A02

Miniature Single Axis Accelerometers

Photo Courtesy of Laboratoire Commun de Métrologie LNE-CNAM

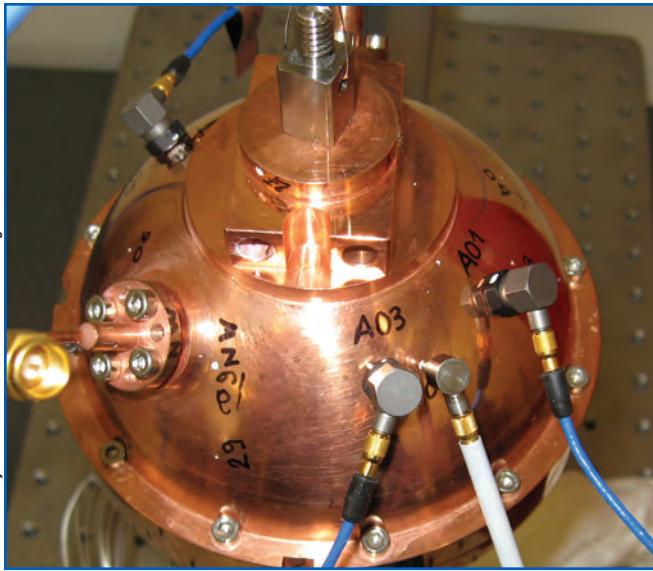

Highlights

- Small size
- High frequency range
- Light weight
- Available in robust titanium or lightweight aluminum housing

Miniature Single Axis Accelerometers

								
Photos Shown Actual Size								
Model Number	353B18	352C68	357B14	353B15	352C65	357B11		
Sensitivity	10 mV/g	100 mV/g	3 pC/g	10 mV/g	100 mV/g	3.0 pC/g		
Measurement Range	±500 g pk	±50 g pk	± 2300 g pk	± 500 g pk	± 50 g pk	± 2300 g pk		
Broadband Resolution	0.005 g rms	0.00016 g rms	[1]	0.005 g rms	0.00016 g rms	[1]		
Frequency Range (± 5%)	1 to 10k Hz	0.5 to 10k Hz	12 kHz [2]	1 to 10k Hz	0.5 to 10k Hz	12 kHz [2]		
Resonant Frequency	≥ 70 kHz	≥ 35 kHz	≥ 50 kHz	≥ 70 kHz	≥ 35 kHz	≥ 50 kHz		
Temperature Range	-65 to +250 °F -54 to +121 °C	-65 to +200 °F -54 to +93 °C	-95 to +500 °F -71 to +260 °C	-65 to +250 °F -54 to +121 °C	-65 to +200 °F -54 to +93 °C	-95 to +500 °F -71 to +260 °C		
Sensing Element	Quartz/Shear	Ceramic/Shear	Ceramic/Shear	Quartz/Shear	Ceramic/Shear	Ceramic/Shear		
Electrical Connector	10-32 Coaxial Jack	10-32 Coaxial Jack	10-32 Coaxial Jack	5-44 Coaxial Jack	5-44 Coaxial Jack	5-44 Coaxial Jack		
Electrical Ground Isolation	No	No	No	No	No	No		
Housing Material	Titanium	Titanium	Titanium	Titanium	Titanium	Titanium		
Sealing	Hermetic	Hermetic	Hermetic	Hermetic	Hermetic	Hermetic		
Weight	1.8 gm	2.0 gm	2.0 gm	2.0 gm	2.0 gm	2.0 gm		
Size	9/32 x 0.64 in 9/32 in x 16.3 mm	9/32 x 0.64 in 9/32 in x 16.3 mm	9/32 x 0.64 in 9/32 in x 16.3 mm	5/16 x 0.43 in 5/16 in x 10.9 mm	5/16 x 0.43 in 5/16 in x 10.9mm	5/16 x 0.43 in 5/16 in x 10.9 mm		
Mounting	5-40 Stud	5-40 Stud	5-40 Stud	5-40 Stud	5-40 Stud	5-40 Stud		
Supplied Accessories								
Wax	080A109	080A109	—	080A109	080A109	—		
Adhesive Mounting Base	080A15	080A15	—	080A15	080A15	—		
Additional Versions								
Metric Mounting Thread	M353B18	M352C68	M357B14	M353B15	M352C65	M357B11		
Alternative Sensitivity	(M)353B14 - 5 mV/g	—	—	(M)353B11 - 5 mV/g	—	—		
Additional Accessories								
Magnetic Mounting Base	080A30	080A30	080A30	080A30	080A30	080A30		
Triaxial Mounting Adaptors	080B16, 080A196	080B16, 080A196	080B16, 080A196	080B16, 080A196	080B16, 080A196	080B16, 080A196		
Mating Cable Connector	EB	EB	EB	AG	AG	AG		
Recommended Cables	002, 003 CE	002, 003 CE	003 CE	018 Flexible, 003 CE	018 Flexible, 003 CE	003 CE		
Notes								
[1] Resolution is dependent upon cable length and signal conditioner [2] Low frequency response determined by external electronics								



Miniature Single Axis Accelerometers

Product testing is necessary in today's competitive marketplace in order to optimize designs, reduce defects, and improve customer acceptance and satisfaction. Shock and vibration testing offers a structured approach for verifying survivability in environmental influences that may be encountered during service and for precipitating incipient failures so they are not encountered by the end-user. PCB® accelerometers are used extensively for monitoring an object's response to a programmed vibration input and for controlling the vibration profiles during testing.



Photo courtesy of Sun Microsystems Advanced Product Testing Laboratory

Miniature Single Axis Accelerometers

Photos Shown Actual Size					
Model Number	352C41	352C42	357B45	355B12	357B06
Sensitivity	10 mV/g	100 mV/g	2.6 pC/g	10 mV/g	5 pC/g
Measurement Range	± 500 g pk	± 50 g pk	± 500 g pk	± 500 g pk	± 500 g pk
Broadband Resolution	0.0008 g rms	0.0005 g rms	[1]	0.0005 g rms	[1]
Frequency Range (± 5%)	1 to 9k Hz	1 to 9k Hz	8 kHz [2]	1 to 10k Hz	10 kHz [2]
Resonant Frequency	≥ 30 kHz	≥ 30 kHz	≥ 30 kHz	≥ 50 kHz	≥ 50 kHz
Temperature Range	-65 to +250 °F -54 to +121 °C	-65 to +250 °F -54 to +121 °C	-100 to +350 °F -73 to +177 °C	-65 to +250 °F -54 to +121 °C	-65 to +500 °F -54 to +260 °C
Sensing Element	Ceramic/Shear	Ceramic/Shear	Ceramic/Shear	Ceramic/Shear	Ceramic/Shear
Electrical Connector	10-32 Coaxial Jack	10-32 Coaxial Jack	10-32 Coaxial Jack	5-44 Coaxial Jack	5-44 Coaxial Jack
Electrical Ground Isolation	No	No	No	Yes	Yes
Housing Material	Titanium	Titanium	Titanium	Titanium	Titanium
Sealing	Hermetic	Hermetic	Hermetic	Hermetic	Hermetic
Weight	2.8 gm	2.8 gm	2.8 gm	2.3 gm	2.3 gm
Size	3/8 x 0.38 in 3/8 in x 9.7 mm	3/8 x 0.38 in 3/8 in x 9.7 mm	3/8 x 0.38 in 3/8 in x 9.7 mm	0.23 x 0.65 x 0.38 in 5.84 x 16.4 x 9.6 mm	0.23 x 0.65 x 0.38 in 5.8 x 16.4 x 9.6 mm
Mounting	Adhesive	Adhesive	Adhesive	Through Hole	Through Hole
Supplied Accessories					
Wax/Adhesive	080A109/080A90	080A109/080A90	080A109	—	—
Mounting Stud/Screw	—	—	—	081B36	081B36
Additional Versions					
Electrical Ground Isolation	352C43	352C44	—	—	—
Metric Mounting Thread	—	—	—	M355B12	M357B06
Additional Accessories					
Mating Cable Connector	EB	EB	EB	AG	AG
Recommended Cables	002, 003 CE	002, 003 CE	003	018 Flexible, 003 CE	003 CE
Notes					
[1] Resolution is dependent upon cable length and signal conditioner [2] Low frequency response determined by external electronics					

Miniature Triaxial Accelerometers

Tips From Techs

Is the cable assembly for my triaxial accelerometer included or do I need to order it separately?

PCB® currently offers four different configurations:

- **Integral Cable** – Any unit with an integral cable normally has a 5 ft. length cable. In addition, a mating 5 ft. extension cable is provided that terminates in (3) BNC Plugs.
- **8-36 4-Pin Jack** – Any unit with this connector is provided with a 10 ft. mating cable assembly that terminates in (3) BNC Plugs
- **¼-28 4-Pin Jack** – Any unit with this connector is not provided with a cable assembly, as this connector is more universal than the 8-36 configuration mentioned above.
- **(3) Independent Coaxial Jacks** – This configuration is used on the Charge Output accelerometers. Cable assemblies are not included with these sensors because coaxial cables are very common.

A listing of all of the accessories that are supplied with each particular sensor can be found in the “Supplied Accessories” section of each accelerometer table, as well as on the published specification sheet at www.pcb.com.

Miniature Triaxial Accelerometers

					
Photo Shown Actual Size					
Model Number	356A01	356A24	356B20	356B21	356B11
Sensitivity	5 mV/g	10 mV/g	1 mV/g	10 mV/g	10 mV/g
Measurement Range	± 1000 g pk	± 500 g pk	± 5000 g pk	± 500 g pk	± 500 g pk
Broadband Resolution	0.003 grms	0.002 rms	0.03 g rms	0.003 grms	0.003 g rms
Frequency Range (± 5%)	2 to 5k Hz	1 to 9k Hz	2 to 7k Hz	2 to 7k Hz	2 to 7k Hz
Resonant Frequency	≥ 50 kHz	≥ 45 kHz	≥ 55 kHz	≥ 55 kHz	≥ 55 kHz
Temperature Range	-65 to +250 °F -54 to +121 °C	-65 to +250 °F -54 to +121 °C	-65 to +250 °F -54 to +121 °C	-65 to +250 °F -54 to +121 °C	-65 to +250 °F -54 to +121 °C
Sensing Element	Ceramic/Shear	Ceramic/Shear	Ceramic/Shear	Ceramic/Shear	Ceramic/Shear
Electrical Connector	Integral Cable	8-36 4-Pin Jack	8-36 4-Pin Jack	8-36 4-Pin Jack	Integral Cable
Electrical Ground Isolation	No	No	No	No	No
Housing Material	Titanium	Titanium	Titanium	Titanium	Titanium
Sealing	Hermetic	Hermetic	Hermetic	Hermetic	Hermetic
Weight	1 gm	3 gm	4 gm	4 gm	4 gm
Size	0.25 in Cube 6.35 mm Cube	0.28 x 0.47 x 0.47 in 7 x 12 x 12 mm	0.4 in Cube 10.2 mm Cube	0.4 in Cube 10.2 mm Cube	0.4 in Cube 10.2 mm Cube
Mounting	Adhesive	Adhesive	5-40 Thread	5-40 Thread	5-40 Thread
Supplied Accessories					
Cable	034G05	034K10	034K10	034K10	034G05
Wax/Adhesive	080A109/080A90	080A109/080A90	080A109	080A109	080A109
Adhesive Mounting Base	—	—	080A	080A	080A
Mounting Stud/Screw	—	—	081A27, M081A27, 081A90	081A27, M081A27, 081A90	081A27, M081A27, 081A90
Additional Versions					
Alternate Cable Type	356A13-Twisted 4-Cond.	—	—	—	—
Built-in Low Pass Filter	—	—	—	—	356A61
Integral Cable	—	—	356B10	—	—
Additional Accessories					
Magnetic Mounting Base	—	—	080A30	080A30	080A30
Removal Tool	—	—	039A08	039A08	039A08
Mating Cable Connector	AY	EH	EH	EH	AY
Recommended Cable	034	034	034	034	034

Miniature Triaxial Accelerometers

Highlights

- Lightweight Titanium
- Hermetic Seal
- Screw, Stud, or Adhesive Mount



Photos Courtesy of Clemson University

Miniature Triaxial Accelerometers

					
Photo Shown Actual Size					
Model Number	354C10	356A33	356A31	356A34	356A32
Sensitivity	10 mV/g	10 mV/g	10 mV/g	50 mV/g	100 mV/g
Measurement Range	± 500 g pk	±500 g pk	± 500 g pk	± 100 g pk	± 50 g pk
Broadband Resolution	0.003 g rms	0.003 rms	0.002 g rms	0.0003 g rms	0.0003 g rms
Frequency Range (± 5%)	2 to 8k Hz	2 to 7k Hz	1 to 10k Hz	0.7 to 4k Hz	0.7 to 4k Hz
Resonant Frequency	≥ 40 kHz	≥ 55 kHz	≥ 70 kHz	≥ 25 kHz	≥ 25 kHz
Temperature Range	-65 to +250 °F -54 to +121 °C	-65 to +250 °F -54 to +121 °C	-65 to +250 °F -54 to +121 °C	-65 to +250 °F -54 to +121 °C	-65 to +250 °F -54 to +121 °C
Sensing Element	Ceramic/Shear	Ceramic/Shear	Ceramic/Shear	Ceramic/Shear	Ceramic/Shear
Electrical Connector	Integral Cable	¼-28 4-Pin Jack	8-36 4-Pin Jack	¼-28 4-Pin Jack	8-36 4-Pin Jack
Electrical Ground Isolation	Yes	No	No	No	No
Housing Material	Titanium	Titanium	Titanium	Titanium	Titanium
Sealing	Hermetic	Hermetic	Hermetic	Hermetic	Hermetic
Weight	5 gm	5 gm	5 gm	7 gm	5 gm
Size	0.3 x 0.55 x 0.55 in 7.6 x 14 x 14 mm	0.4 in Cube 10.2 mm Cube	0.45 in Cube 11.4 mm Cube	0.45 in Cube 11.4 mm Cube	0.45 in Cube 11.4 mm Cube
Mounting	Through Hole	5-40 Thread	Adhesive	Adhesive	5-40 Thread
Supplied Accessories					
Cable	034G05	—	034K10	—	034K10
Wax/Adhesive	—	080A109	080A109	080A109	080A109
Adhesive Mounting Base	—	080A	—	—	080A
Mounting Stud/Screw	081B93	081A27, M081A27, 081A90	—	—	081A27, M081A27, 081A90
Additional Versions					
Built-in Low Pass Filter	—	356A63	—	—	—
Integral Cable	—	—	—	—	356A12
Alternate Sensitivity	—	—	356A30 - 5 mV/g	356A36 - 10 mV/g	—
Alternate Sensitivity	—	—	—	356A35 - 100 mV/g	—
Metric Mounting Thread	M354C10	—	—	—	—
Additional Accessories					
Magnetic Mounting Base	—	—	—	—	080A30
Removal Tool	—	039A08	039A09	039A09	039A09
Mating Cable Connector	AY	AY	EH	AY	EH
Recommended Cable	034	034	034	034	034

High Temperature ICP® Accelerometers (+325 °F/+163 °C)

Applications

- Quality Assurance (HALT, HASS, ESS)
- High Temperature
- Thermal Stress Screening
- Environmental Testing
- Combined Environmental Chambers

PCB® offers specially designed and tested ICP® accelerometers for conducting vibration and shock measurements under demanding environmental conditions. These sensors combine proven quartz, and ceramic shear sensing technology with specialized, built-in, microelectronic signal conditioning circuitry to achieve dependable operation in extreme temperatures and through repetitive temperature cycling. Laser-welded, hermetically sealed, lightweight titanium or stainless steel housings offer further protection from the environment.

Prior to shipment, each sensor undergoes a battery of tests to ensure survivability for its intended use. Such tests include temperature soak at elevated temperatures, temperature cycling, and exposure to highly accelerated screening procedures with hydraulically actuated shakers.

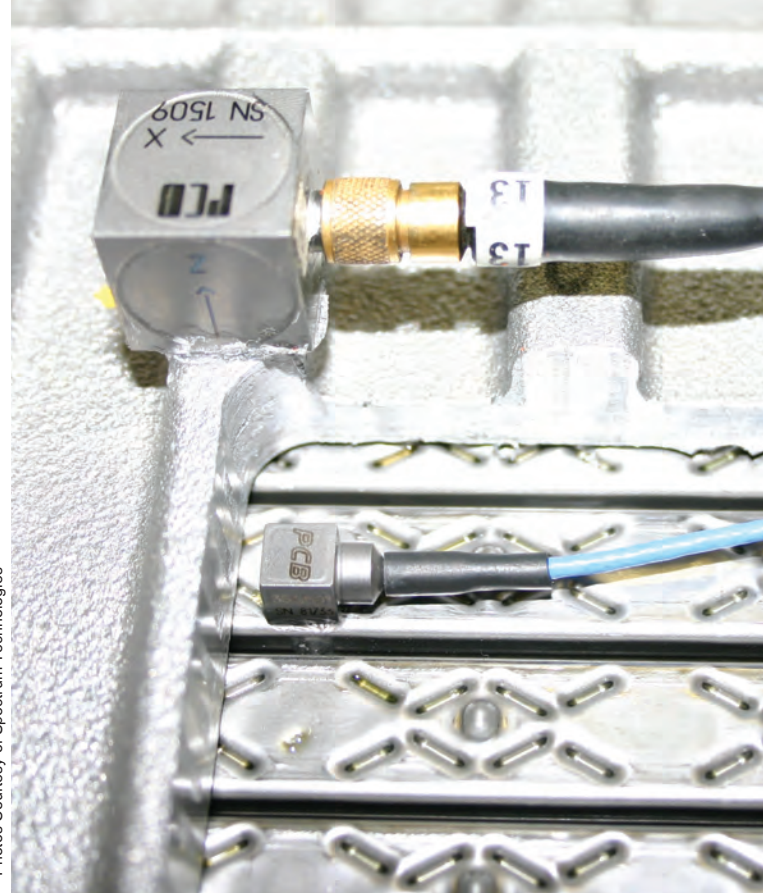

Photos Courtesy of Spectrum Technologies





High Temperature Single Axis ICP® Accelerometers

Environmental testing chambers play a vital role for many products during development and testing. These tools permit accelerated life cycle testing of products under extreme conditions to build confidence in reliability and longevity. Temperature, humidity, and altitude are prevalent simulated environments accommodated by such chambers. Vibration stimulus is often combined with temperature cycling to more closely approximate real-world operating environments. When vibration control or response measurements are needed for such combined-environment tests, PCB® offers high temperature ICP® accelerometers that have been qualified against their own vibration stress screening and thermal cycling regimen to withstand the extreme test chamber conditions.



Photo Courtesy of Sun Microsystems Advanced Product Testing Laboratory

High Temperature ICP® Accelerometers

				
Photos Shown Actual Size				
Model Number	320C15	320C18	320C03	320C33
Sensitivity	10 mV/g	10 mV/g	10 mV/g	100 mV/g
Measurement Range	± 500 g pk	± 500 g pk	± 500 g pk	± 50 g pk
Broadband Resolution	0.005 g rms	0.005 g rms	0.005 g rms	0.0003 g rms
Frequency Range (± 5%)	2 to 10k Hz	2 to 10k Hz	1 to 6k Hz	1 to 4k Hz
Resonant Frequency	≥ 60 kHz	≥ 60 kHz	≥ 35 kHz	≥ 22 kHz
Temperature Range	-100 to +325 °F -73 to +163 °C	-100 to +325 °F -73 to +163 °C	-100 to +325 °F -73 to +163 °C	-100 to +325 °F -73 to +163 °C
Sensing Element	Quartz/Shear	Quartz/Shear	Quartz/Shear	Quartz/Shear
Electrical Connector	5-44 Coaxial Jack	10-32 Coaxial Jack	10-32 Coaxial Jack	10-32 Coaxial Jack
Electrical Ground Isolation	No	No	No	No
Housing Material	Titanium	Titanium	Titanium	Titanium
Sealing	Hermetic	Hermetic	Hermetic	Hermetic
Weight	2 gm	2 gm	11 gm	20 gm
Size	5/16 x 0.43 in 5/16 in x 10.9 mm	9/32 x 0.74 in 9/32 in x 18.8 mm	1/2 x 0.81 in 1/2 in x 20.6 mm	3/4 x 0.85 in 3/4 in x 21.6 mm
Mounting	5-40 Stud	5-40 Stud	10-32 Thread	10-32 Thread
Supplied Accessories				
Wax	080A109	080A109	080A109	080A109
Adhesive Mounting Base	080A15	080A15	—	080A12
Mounting Stud/Screw	—	—	081B05, M081B05	081B05, M081B05
Additional Versions				
Metric Mounting	M320C15	M320C18	—	—
Alternate Connector Position	—	—	320C04 - Top	320C34 - Top
Additional Accessories				
Magnetic Mounting Base	080A30	080A30	080A27	080A27
Triaxial Mounting Adaptors	080B16, 080A196	080B16, 080A196	080B10	080B11
Mating Cable Connector	AG	EB	EB	EB
Recommended Cables	002, 003 CE	002, 003 CE	002, 003 CE	002, 003 CE

High Temperature ICP[®] Accelerometers



High Temperature ICP[®] Accelerometers

				
	CE	CE	CE	CE
Model Number	300A12	320C20	339A30	339A31
Sensitivity	10 mV/g	10 mV/g	10 mV/g	10 mV/g
Measurement Range	± 250 g pk	± 500 g pk	± 500 g pk	± 500 g pk
Broadband Resolution	0.002 g rms	0.006 g rms	0.008 g rms	0.008 g rms
Frequency Range (± 5%)	10 to 10k Hz	2 to 5k Hz	2 to 8k Hz	2 to 8k Hz
Resonant Frequency	≥ 60 kHz	≥ 60 kHz	≥ 25 kHz	≥ 25 kHz
Temperature Range (sensor)	-100 to +500 °F -73 to +260 °C	-100 to +325 °F -73 to +163 °C	-65 to +325 °F -54 to +163 °C	-65 to +325 °F -54 to +163 °C
Sensing Element	Ceramic/Shear	Quartz/Shear	Shear	Shear
Electrical Connector	10-32 Coaxial Jack	10-32 Coaxial Jack	8-36 4-Pin Jack	8-36 4-Pin Jack
Housing Material	Stainless Steel	Titanium	Titanium	Titanium
Sealing	Hermetic	Hermetic	Hermetic	Hermetic
Weight (sensor)	5.4 gm	6.5 gm	4 gm	5.5 gm
Size (sensor)	3/8 x 0.87 in 3/8 in x 22.1 mm	3/8 x 0.87 in 3/8 x 22.1 mm	0.4 in Cube 10.2 mm Cube	0.55 x 0.4 x 0.4 in 14 mm x 10.2 mm x 10.2 mm
Mounting	10-32 Stud	10-32 Thread	Adhesive	5-40 Stud
System Components				
Accelerometer	357M50	—	—	—
Cable	16950-01	—	034K10	034K10
Charge Converter	422M136	—	—	—
Supplied Accessories				
Wax/Adhesive	—	080A109	080A109/080A90	080A109/080A90
Adhesive Mounting Base	—	080A	—	080A
Mounting Stud/Screw	—	—	—	081A27, M081A27
Additional Versions				
Metric Mounting	—	M320C20	—	—

High Temperature Accelerometers (>+500 °F/+260 °C)

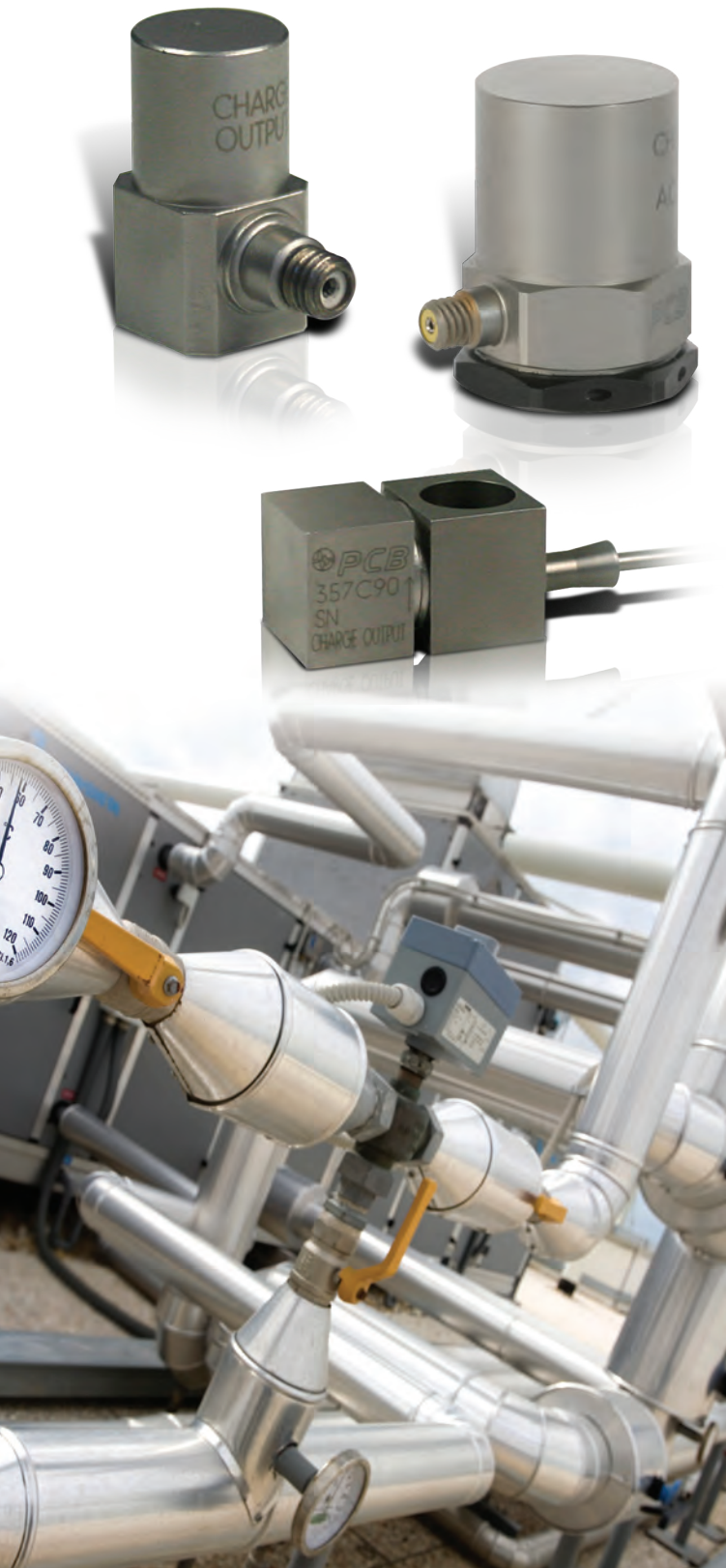

Applications

- High Temperature Vibration Measurements
- Engine Compartment Studies
- Exhaust Component Vibration Tests
- Steam Turbine Testing
- Engine Vibration Analysis

PCB®'s Charge Output accelerometers utilize piezo-ceramic sensing elements to directly output an electrostatic charge signal that is proportional to applied acceleration.

Charge Output accelerometers do not contain built-in signal conditioning electronics. As a result, external signal conditioning is required to interface their generated measurement signals to readout or recording instruments. The sensor's charge output signals can be conditioned with either a laboratory style, adjustable charge amplifier or, for an economical approach, with an in-line, fixed charge converter.

Since there are no electronics built into Charge Output accelerometers, they can operate and survive exposure to very high temperatures (up to +1200 °F/+649 °C for some models). In addition, Charge Output accelerometers are used for thermal cycling requirements or to take advantage of existing charge amplifier signal conditioning equipment.

It is important to note that measurement resolution and low-frequency response for charge output, acceleration sensing systems are dependent upon the noise floor and discharge time constant characteristics of the signal conditioning and readout devices used.



High Temperature Single Axis Accelerometers

High Temperature, Single Axis Accelerometers

				
Model Number	357B69	357C90	357B61	357B53
Sensitivity	3.5 pC/g	5 pC/g	10 pC/g	100 pC/g
Measurement Range	± 500 g pk	± 1000 g pk	± 1000 g pk	± 150 g pk
Broadband Resolution	[1]	[1]	[1]	[1]
Frequency Range (± 5%)	6 kHz [2]	2.5 kHz [2]	5 kHz [2]	3 kHz [2]
Resonant Frequency	≥ 35 kHz	≥ 14 kHz	≥ 24 kHz	≥ 12 kHz
Temperature Range	-65 to +900 °F -54 to +482 °C	-67 to +1200 °F -55 to +649 °C	-65 to +900 °F -54 to +482 °C	-95 to +550 °F -71 to +288 °C
Radiation Exposure Limit Integrated Gamma Flux Integrated Neutron Flux	$\leq 10^8$ rad $\leq 10^{10}$ N/cm ²	$\leq 10^8$ rad $\leq 10^{10}$ N/cm ²	$\leq 10^8$ rad $\leq 10^{10}$ N/cm ²	$\leq 10^8$ rad $\leq 10^{10}$ N/cm ²
Sensing Element	Ceramic/Compression	Ceramic/Shear	Ceramic/Compression	Ceramic/Shear
Electrical Connector	10-32 Coaxial Jack	Integral Cable	10-32 Coaxial Jack	10-32 Coaxial Jack
Electrical Ground Isolation	No	Yes	No	Yes
Housing Material	Inconel	Inconel	Inconel	Titanium
Sealing	Hermetic	Hermetic	Hermetic	Hermetic
Weight	16 gm	75 gm	30 gm	51 gm
Size	0.45 x 0.875 in 11.4 in x 22.2 mm	0.66 x 1.26 x 0.66 in 16.7 x 32 x 16.7 mm	5/8 x 1 in 5/8 in x 25.4 mm	3/4 x 1.13 in 3/4 in x 28.7 mm
Mounting	10-32 Thread	Through-hole	10-32 Thread	10-32 Thread
Supplied Accessories				
Cable	023A10	—	023A10	—
Mounting Stud/Screw	081A107, M081A107	081A108	081A107, M081A107	081B05, M081B05
Additional Version				
Alternate Connector Position	—	—	—	357B54 - Top
Additional Accessories				
Adhesive Mounting Base	080A12	—	080A12	080A12
Magnetic Mounting Base	080A27	—	080A27	080A27
Triaxial Mounting Adaptor	080B11	—	080B11	080B11
Mating Cable Connector	FZ	FZ	FZ	FZ
Recommended Cable	023	023	023	023
Note				
[1] Resolution is dependent upon cable length and signal conditioner [2] Low Frequency response determined by external electronics				

High Sensitivity ICP® Accelerometers

Applications

- Building Vibration Monitoring
- Earthquake Detection
- Structural Testing of Bridges
- Floor Vibration Monitoring
- Geological Formation Studies
- Foundation Vibration Monitoring

High sensitivity, ICP® accelerometers are specifically designed to enable the detection of ultra-low-level, low-frequency vibrations associated with very large structures, foundations, and earth tremors. These sensors typically possess exceptional measurement resolution as the result of a comparatively larger size, which furnishes a stronger output signal and a lower noise floor.

Both ceramic and quartz sensing elements are utilized in seismic accelerometer designs. Model 393C, with a quartz sensing element, offers the best low-frequency response in this series. Ceramic element styles with built-in, low-noise, signal conditioning circuitry offer the greatest measurement resolution. The model 393B31 leads the way, providing 1 μ g rms broadband resolution.

All units are hermetically sealed in either a titanium or stainless steel housing. Models that include a 2-pin, military style connector provide the added benefit of being electrically case isolated for superior RF and EMI protection.





High Sensitivity ICP® Accelerometers

Vibration monitoring of civil structures and treasured monuments can be an essential practice for ensuring the safety of occupants or protecting the structure from catastrophic demise. Studies have shown that crowds of people in a stadium grandstand or theater balcony can impart tremendous forces and harmonic motion to the structure when the crowd acts in a synchronous manner. Earth tremors, foot traffic, and trucks & trains can impart vibration, which can cause a structure to sway, shift, crumble, or collapse. Permanent-monitoring high-sensitivity accelerometers are useful for trending, analyzing, and alerting when structural motion exceeds established safety limits to enable corrective or evasive action.

High Sensitivity ICP® Accelerometers

				
Model Number	355B04	352B	393B04	393B05
Sensitivity	1000 mV/g	1000 mV/g	1000 mV/g	10 V/g
Measurement Range	± 5 g pk	± 5 g pk	± 5 g pk	± 0.5 g pk
Broadband Resolution	0.0001 g rms	0.00008 g rms	0.000003 g rms	0.000004 g rms
Frequency Range (± 5%)	1 to 8k Hz	2 to 10k Hz	0.06 to 450 Hz	0.7 to 450 Hz
Resonant Frequency	≥ 30 kHz	≥ 25 kHz	≥ 2.5 kHz	≥ 2.5 kHz
Temperature Range	-65 to +200 °F -54 to +93 °C	-65 to +200 °F -54 to +93 °C	0 to +176 °F -18 to +80 °C	0 to +176 °F -18 to +80 °C
Sensing Element	Ceramic/Shear	Ceramic/Shear	Ceramic/Flexural	Ceramic/Flexural
Electrical Connector	10-32 Coaxial Jack	10-32 Coaxial Jack	10-32 Coaxial Jack	10-32 Coaxial Jack
Electrical Ground Isolation	Yes	No	No	No
Housing Material	Titanium	Titanium	Titanium	Titanium
Sealing	Hermetic	Hermetic	Hermetic	Hermetic
Weight	11 gm	25 gm	50 gm	50 gm
Size	0.40 x 0.95 x 0.63 in 10.2 x 24 x 16 mm	3/4 x 1.10 in 3/4 in x 28 mm	0.99 x 1.22 in 25 x 31 mm	0.99 x 1.22 in 25 x 31 mm
Mounting	Through Hole	10-32 Thread	10-32 Thread	10-32 Thread
Supplied Accessories				
Wax/Adhesive	080A109	080A109	—	—
Adhesive Mounting Base	—	080A12	—	—
Mounting Stud/Screw	081B45	081B05, M081B05	081B05, M081B05	081B05, M081B05
Additional Accessories				
Magnetic Mounting Base	—	080A27	—	—
Triaxial Mounting Adaptor	—	080B11	—	—
Mating Cable Connector	EB	EB	EB	EB
Recommended Cables	002, 003 CE	002, 003 CE	002, 003 CE	002, 003 CE

High Sensitivity ICP® Accelerometers

Decaying infrastructures, particularly bridges, have received heightened awareness in recent years. Among the several techniques for determining the health and longevity of such civil structures are vibration measurements for continuous monitoring, modal analysis, and structural integrity investigation. High sensitivity accelerometers are utilized for generating signals in response to a variety of stimuli including traffic, wind, and programmatic impulse. When analyzed, these signals provide insight for determining the condition and safety of the structure. Such an investigative analysis can lead to a recommendation for remedial construction or further monitoring.



High Sensitivity ICP® Accelerometers

				
Model Number	393A03	393B12	393B31	393C
Sensitivity	1000 mV/g	10 V/g	10 V/g	1000 mV/g
Measurement Range	± 5 g pk	± 0.5 g pk	± 0.5 g pk	± 2.5 g pk
Broadband Resolution	0.00001 g rms	0.000008 g rms	0.000001 g rms	0.0001 g rms
Frequency Range (± 5%)	0.5 to 2000 Hz	0.5 to 2000 Hz	0.1 to 200 Hz	0.02 to 800 Hz
Frequency Range (± 10%)	0.3 to 4000 Hz	0.1 to 2000 Hz	0.07 to 300 Hz	0.01 to 1200 Hz
Resonant Frequency	≥ 10 kHz	≥ 10 kHz	≥ 700 Hz	≥ 3.5 kHz
Temperature Range	-65 to +250 °F -54 to +121 °C	-50 to +180 °F -45 to +82 °C	0 to +150 °F -18 to +65 °C	-65 to +200 °F -54 to +93 °C
Sensing Element	Ceramic/Shear	Ceramic/Shear	Ceramic/Flexural	Quartz/Compression
Electrical Connector	2-Pin MIL-C-5015	2-Pin MIL-C-5015	2-Pin MIL-C-5015	10-32 Coaxial Jack
Electrical Case Isolation	Yes	Yes	Yes	No
Housing Material	Stainless Steel	Stainless Steel	Stainless Steel	Stainless Steel
Sealing	Hermetic	Hermetic	Hermetic	Hermetic
Weight	210 gm	210 gm	635 gm	885 gm
Size	1 3/16 x 2.21 in 1 3/16 in x 56.1 mm	1 3/16 x 2.21 in 1 3/16 in x 56.1 mm	2.25 x 2.8 in 57.2 x 71.1 mm	2.25 x 2.16 in 57.2 x 54.9 mm
Mounting	1/4-28 Thread	1/4-28 Thread	1/4-28 Thread	10-32 Thread
Supplied Accessories				
Mounting Stud/Screw	081B20, M081B20	081B20, M081B20	081B20, M081B20	081B05, M081B05
Additional Accessories				
Magnetic Mounting Base	080A54	080A54	—	080A21
Triaxial Mounting Adaptor	080A57	080A57	080M189	080M16
Mating Cable Connector	AP	AP	AP	EB
Recommended Cables	024	024	024	002, 003 CE

Structural Test ICP[®] Accelerometers

Applications

- Structural Vibration Testing
- Multi-channel Modal Analysis
- Analytical Model Correlation
- Design Studies
- Force Response Simulation

The Series 333 ICP[®] accelerometers, and their accessories, have been specifically designed to address the needs of multi-point modal and structural test measurement applications. This equipment has been developed in conjunction with the world renowned University of Cincinnati Structural Dynamics Research Laboratory and proven in real-world testing situations.

All accelerometers feature high-output, piezoceramic sensing elements for strong output signal levels when measuring lower-amplitude input vibrations. All reduce mass-loading effects by employing ultra-lightweight casing materials. All exhibit minimal phase deviation, an important consideration for mode shape analysis.

Each unit in this family includes TEDS functionality as an option. A sensor incorporating a Transducer Electronic Data Sheet (TEDS) is a mixed-mode (analog/digital) sensor with a built-in read/write memory that contains information about the sensor and its use. A TEDS sensor has an internal memory that includes information about the manufacturer, specifications and calibration, defined by IEEE standard 1451.4, effectively giving it the ability of "plug-and-play" self-identification within a measurement system. Using the same two-wire design of traditional piezoelectric with internal charge amplifier transducers, the TEDS sensor can flip between analog and digital modes, functioning with either a typical analog output, or with a digital bit stream output. Although a TEDS sensor can be connected to any ICP[®] sensor signal conditioner, only a TEDS-capable ICP[®] signal conditioner and data acquisition equipment support the digital communication mode.

Mounting pads, multi-conductor signal cables, and patch panels all help to control and organize the cable bundles of sensor arrays. This helps to minimize set-up time and potential errors that are often the result of cable tangles encountered during multi-channel structural testing.



Structural Test ICP® Accelerometers

Highlights

- High output piezoceramic sensing element for strong output signal
- Lightweight casing materials to minimize mass loading effects
- Available in a variety of packages, mounting and cable options

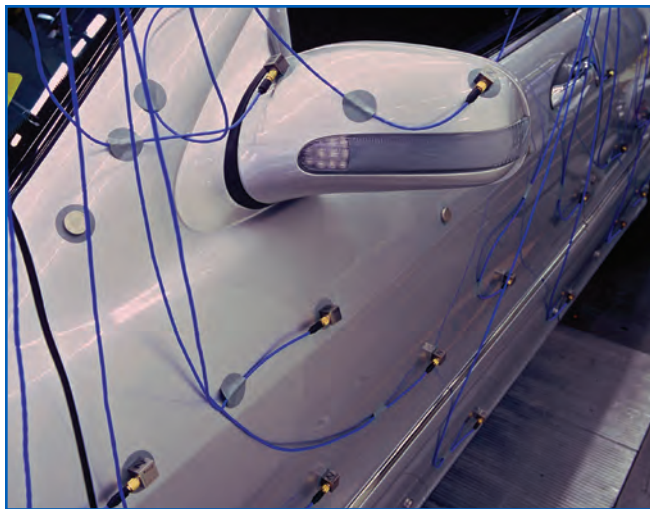

Structural Test ICP® Accelerometers

				
Photos Shown	Actual Size			
Model Number	333B	333B30	333B40	333B50
Sensitivity	100 mV/g	100 mV/g	500 mV/g	1000 mV/g
Measurement Range	± 50 g pk	± 50 g pk	± 10 g pk	± 5 g pk
Broadband Resolution	0.00007 g rms	0.00015 g rms	0.00005 g rms	0.00005 g rms
Frequency Range (± 5%)	2 to 1k Hz	0.5 to 3k Hz	0.5 to 3k Hz	0.5 to 3k Hz
Resonant Frequency	≥ 5 kHz	≥ 40 kHz	≥ 20 kHz	≥ 20 kHz
Temperature Range	0 to +150 °F -18 to +66 °C	0 to +150 °F -18 to +66 °C	0 to +150 °F -18 to +66 °C	0 to +150 °F -18 to +66 °C
Sensing Element	Ceramic/Shear	Ceramic/Shear	Ceramic/Shear	Ceramic/Shear
Electrical Connector	3-Pin Socket	10-32 Coaxial Jack	10-32 Coaxial Jack	10-32 Coaxial Jack
Housing Material	Polymer	Titanium	Titanium	Titanium
Sealing	Hermetic	Hermetic	Hermetic	Hermetic
Weight	5.6 gm	4.0 gm	7.5 gm	7.5 gm
Size	0.48 x 0.84 in 11.9 x 21.3 mm	0.4 in Cube 10.2 mm Cube	0.45 in Cube 11.4 mm Cube	0.45 in Cube 11.4 mm Cube
Mounting	Adhesive	5-40 Thread	5-40 Thread	5-40 Thread
Supplied Accessories				
Wax/Adhesive	—	080A109/080A90	080A109/080A90	080A109/080A90
Adhesive Mounting Base	—	080A25	080A25	080A25
Mounting Stud/Screw	—	081A27, M081A27	081A27, M081A27	081A27, M081A27
Additional Versions				
Alternate Mounting	—	333B32 - Adhesive	333B42 - Adhesive	333B52 - Adhesive
Alternate Connector Position	—	333B35 - Top	333B45 - Top	—
Additional Accessories				
Adhesive Mounting Base and Cable	080B37, 080B38, 080B40	—	—	—
Triaxial Mounting Adaptor	080B55, 080A141	—	—	—
Removal Tool	—	039A08	039A09	—
Mating Cable Connector	—	EB	EB	EB
Recommended Cables	080B38	002, 003 CE	002, 003 CE	002, 003 CE

■ See models 356A16, 356A17, & 356B18 listed on page 8 for Triaxial Configuration of Structural Test ICP® Accelerometers.

MEMS DC Response Accelerometers

When analysis of very low frequency motion or constant acceleration is required, MEMS accelerometers are necessary. Unlike piezoelectric accelerometers, these sensors respond to 0 Hz and are, therefore, often referred to as DC response sensors.

PCB® Series 3741 DC response accelerometers are offered in a variety of full-scale ranges, from ± 2 to ± 200 g. The units feature silicon MEMS sensing elements for uniform, repeatable performance. Gas damping, mechanical over range stops, and a low profile, hard-anodized, aluminum housing are utilized for added durability. Electrically, the units offer a differential output signal for common-mode noise rejection.

PCB® Series 3711 (single axis) and 3713 (triaxial) DC response accelerometers are designed to measure low frequency vibration and motion, and are offered in full-scale ranges from ± 2 to ± 200 g, to accommodate a variety of requirements. The units feature gas-damped, silicon MEMS sensing elements that provide performance, while hermetically sealed titanium housings provide protection from harsh contaminants. These units are inherently insensitive to base strain and transverse acceleration effects, and offer high frequency overload protection. Electrically, the units offer a single-ended output signal for each channel with power and ground leads.

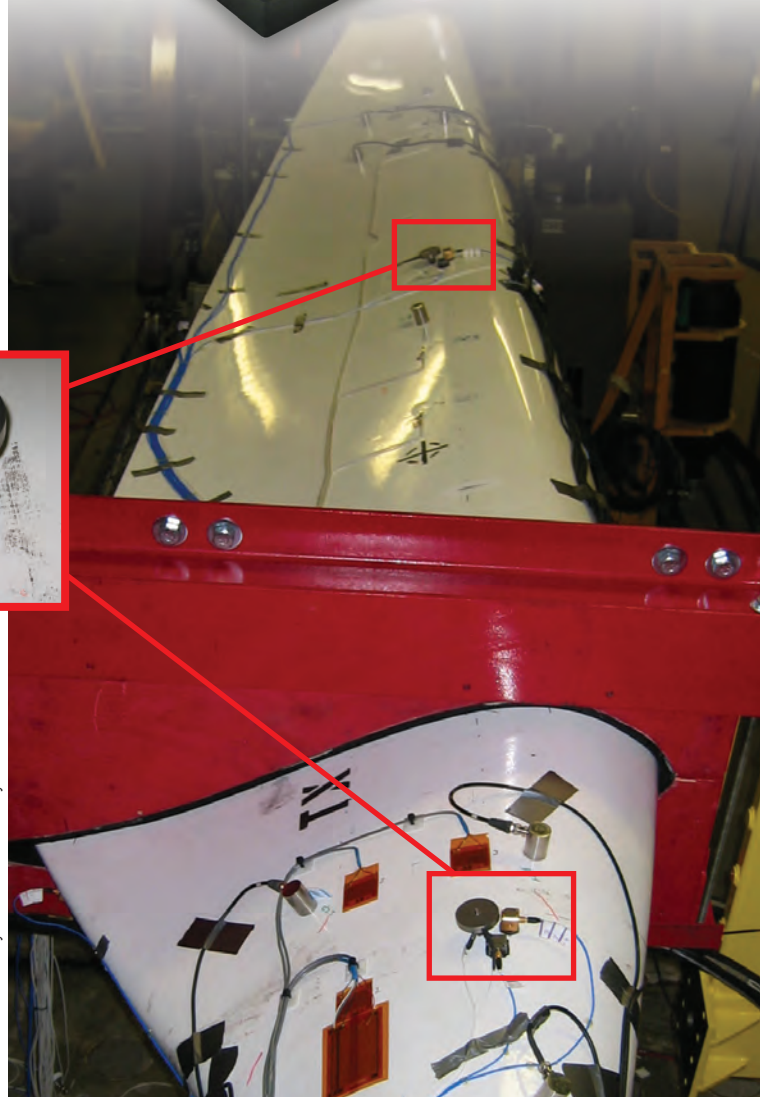
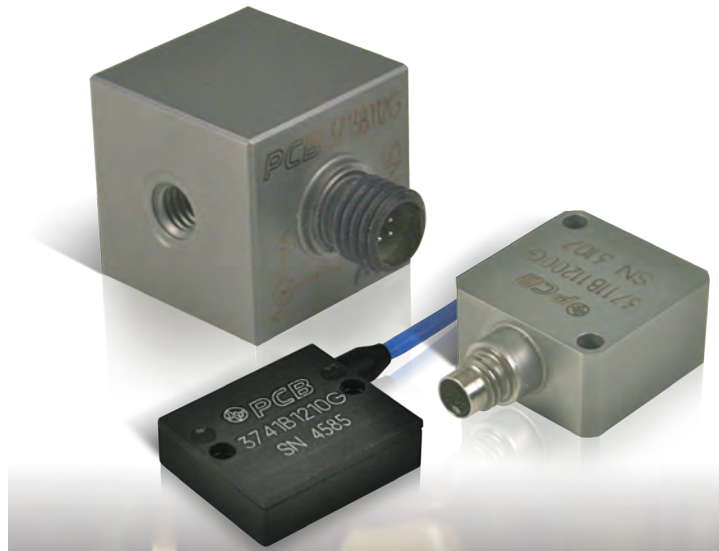

Photos Courtesy of Purdue University

MEMS DC Response Accelerometers

Highlights

- Single axis and triaxial configurations
- Integral cable or multi-pin electrical connectors
- Simple, DC-power excitation schemes
- Single-ended or differential output signal formats

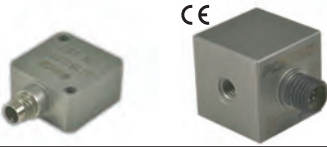

MEMS DC Response Accelerometers				
Series 3741				
	Sensitivity	Measurement Range (pk)	Frequency (± 5%)	Broadband Resolution (rms)
	10 mV/g	± 200 g	0 to 2000 Hz	5.1 mg
	20 mV/g	± 100 g	0 to 2000 Hz	4.5 mg
	40 mV/g	± 50 g	0 to 2000 Hz	2.5 mg
	66.7 mV/g	± 30 g	0 to 2000 Hz	2.5 mg
	200 mV/g	± 10 g	0 to 200 Hz	1.1 mg
1000 mV/g	± 2 g	0 to 150 Hz	0.3 mg	
Series 3711 and 3713				
	10 mV/g	± 200 g	0 to 850 Hz	21.1 mg
	40 mV/g	± 50 g	0 to 1000 Hz	6.0 mg
	66.7 mV/g	± 30 g	0 to 1000 Hz	3.5 mg
	200 mV/g	± 10 g	0 to 1000 Hz	1.2 mg
	1000 mV/g	± 2 g	0 to 250 Hz	0.2 mg
Model Number	3741 Single Axis	3711 Single Axis	3713 Triaxial	
Output Configuration	Differential	Single-Ended	Single-Ended	
Overload Limit (Shock)	± 5,000 g pk	± 3000 g pk	± 3000 g pk	
Temperature Range	-65 to +250 °F -54 to +121 °C	-65 to +250 °F -54.0 to +121 °C	-65 to +250 °F -54 to +121 °C	
Excitation Voltage	6 to 30 VDC	6 to 30 VDC	6 to 30 VDC	
Housing Material	Anodized Aluminum	Titanium	Titanium	
Sealing	Epoxy	Hermetic	Hermetic	
Size	0.30 x 1.00 x 0.85 in 7.62 x 25.4 x 21.6 mm	0.45 x 0.85 x 0.85 in 11.4 x 21.6 x 21.6 mm	0.8 in Cube 20.3 mm Cube	
Weight	—	16.3 gm	17.3 gm	
Connector style	—	65.0 gm	119.0 gm	
Integral cable style	10 gm	—	—	
Electrical Connector	10 ft. (3 m) Integral Cable	1/4-28 4-Pin or 10 ft. (3 m) Integral Cable	9-Pin or 10 ft. (3 m) Integral Cable	
Model No. - Multi-pin Connector	—	3711B11xxxG [1]	3713B11xxxG [1]	
Model No. - Integral Cable	3741D4HBxxxG [1]	3711B12xxxG [1]	3713B12xxxG [1]	
Supplied Accessories				
Easy Mount Clip	—	080A152	—	
Adhesive Base	—	—	080A12	
Mounting Screw/Stud	081A103 M081A103	081A113 M081A113	081B05 M081B05	
Additional Accessories				
Triaxial Mounting Block	080A208	080A153	—	
Mounting Cable Connector	—	AY	EN	
Recommended Cable	—	010	037	
Note				
[1] xxx corresponds to measurement range				

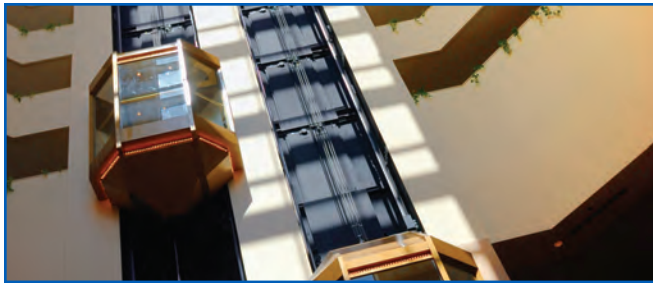

MEMS Sensor Signal Conditioners



MEMS Sensor Signal Conditioners

				
Model Number	478A01	478B05	478A16	482C27
Channels	1	3	16	4
Sensor Input Type(s)	Single-ended MEMS Capacitive	Single-ended MEMS Capacitive	Single-ended MEMS Capacitive	Diff./Single-ended MEMS/Bridge, ICP/Voltage
Compatible Sensor Series	3711, 3713	3711, 3713	3711, 3713	350x, 360x, 371x, 374x, Load Cells
Gain	Unity	Unity	Unity	x0.1 to x2000; x0.1 to x200 [5]
Output Range	±5 V	±5 V	±10 V	±10 V
Frequency Response (±5%) (Unity Gain)	DC to 2k Hz	DC to 2k Hz	DC to 70k Hz [3]	DC to 100k Hz
Temperature Range	+32 to +120 °F 0 to +50 °C	+32 to +120 °F 0 to +50 °C	+32 to +120 °F 0 to +50 °C	+32 to +120 °F 0 to +50 °C
Excitation Voltage	>16 VDC	17.3 VDC	18 VDC	0 to 12 VDC Unipolar or Bipolar [6]
Broadband Electrical Noise (1 to 100,000 Hz) (Gain x1)	8 µV rms [1]	5 µV rms	70 µV rms	50 µV rms
Power Required	27 VDC	33-38 VDC [2]	100 to 240 VAC, 50 to 400 Hz	9 to 18 VDC [2]
Input Connectors	4-Pin Jack	4-Pin Jack	(16) 4-Pin Jacks, (1) DB50 Female	(4) 8-Socket Mini DIN, (4) BNC Jacks
Output Connectors	BNC Jack	BNC Jacks	(16) BNC Jacks, (1) DB37 Female [4]	BNC Jacks
Size (Height x Width x Depth)	4.0 x 2.9 x 2.4 in 10.2 x 7.4 x 6.1 cm	6.3 x 2.4 x 11 in 16.0 x 6.1 x 28.0 cm	3.5 x 19 x 16.25 in 8.9 x 48.3 x 41.3 cm	3.2 x 8.0 x 5.9 in 8.1 x 20 x 15 cm
Weight	0.69 lb 312 gm	1.67 lb 756 gm	8.5 lb 3.9 kg	2.5 lb 1.13 kg
Supplied Accessories				
Power Cord	—	017AXX	017AXX	017AXX
Universal Power Adaptor	—	488B04/NC	—	488B14/NC
MCSC Control Software	—	—	—	EE75
Additional Versions				
Line Powered with Gain	445C01	—	—	—
Base Configurable Model with Selectable Options	—	—	478A17	—
8-channel	—	—	478A18	—
8-channel Base Configurable Model with Selectable Options	—	—	478A19	—
Screw Terminal Input Connector	—	478A05	—	—
3-Channel Differential Input Only	—	—	—	478A30
Additional Accessories				
AC Power Source	488A03 or F488A03	—	—	—
Battery Charger	488A02 or F488A02	—	—	—
9 VDC Ultralife Lithium Batteries (3)	400A81	—	—	—
DC Power Pack	—	488B07	—	—
Auto Lighter Adaptor	—	488A11	—	488A13
Input Mating Connector	AY	AY	AY, DB50 Male	8-pin Mini DIN, AC
Notes				
[1] Noise measured from 0.1 Hz to 10k Hz [2] Supplied with 85 to 264 VAC, 47 to 400 Hz Universal Power Adaptor [3] ±1% DC to 40 kHz (minimum) [4] BNC jacks on both front and rear panels [5] Maximum gain for bridge/MEMS input is x2000 and for ICP/voltage is x200 [6] In bipolar mode, +Vexc track each other. They are equal and opposite. User selectable in 0.1V increments				

Shock ICP[®] Accelerometers



Applications:

- Pile Driver Monitoring
- Simulated Pyroshock Events
- Recoil and Penetration
- Impact Press Monitoring
- Explosive Studies
- Shaker Impact Monitoring

Shock accelerometers are specifically designed to withstand and measure extreme, high-amplitude, short-duration, transient accelerations. Such accelerations characteristically exceed the 1000 g boundary imposed on typical accelerometer designs. Shock acceleration events may reach 100,000 g or more with pulse durations of less than 10 microseconds. The extremely fast transient and volatile nature of a shock event imposes special demands on the design of a shock accelerometer.

PCB[®] shock accelerometers represent extensive research in materials, assembly techniques, and testing techniques to ensure survivability and faithful representation of the shock event. An automated Hopkinson Bar Calibration Station is utilized to evaluate shock sensor performance by simulating actual, high amplitude measurement conditions. This investment allows PCB[®] to assess and improve upon individual sensor characteristics, such as zero shift, ringing, and non-linearity.

Shear mode quartz and ceramic sensing elements are used in shock accelerometer designs to minimize the effects of base strain and thermal transients. Ceramic elements yield a smaller, lighter weight sensor with higher amplitude range and frequency limits. Quartz elements offer a wider operating temperature, thereby allowing for a more general purpose measurement device. Built-in signal conditioning circuitry permit these ICP[®] sensors to operate from constant-current signal conditioners for reliable operation and simplicity of use. The addition of mechanical and electrical filtering, in some designs, assists in resonance suppression to eliminate high-frequency “ringing” in the output signal.

A general purpose charge mode unit is available for systems employing external charge amplifiers and where adjustability through a wide measurement range is desired, such as with near- and far-field pyroshock testing.

Shock ICP® Accelerometers

Applications

- Body Armor Piercing
- Impact Testing
- Metal-to-Metal
- Helmet Testing

Photo Courtesy of Clemson University

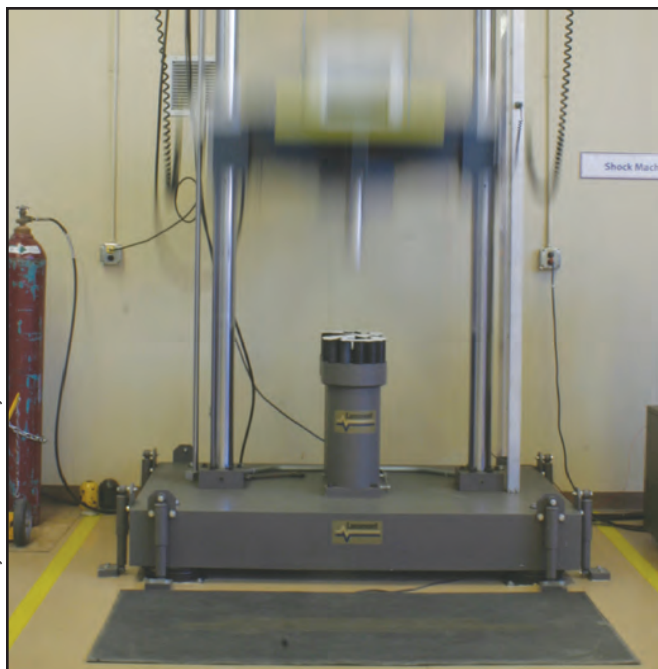

Shock Accelerometers

Photo Shown Actual Size





Model Number	350B21	350D02	350C23	350C24
Sensitivity	0.05 mV/g	0.1 mV/g	0.5 mV/g	1 mV/g
Measurement Range	± 100,000 g pk	± 50,000 g pk	± 10,000 g pk	± 5000 g pk
Broadband Resolution	0.3 g rms	0.5 g rms	0.04 g rms	0.02 g rms
Frequency Range (± 1 dB)	1 to 10k Hz	4 to 10k Hz	0.4 to 10k Hz	0.4 to 10k Hz
Electrical Filter Corner	—	13 kHz (-3 dB)	13 kHz (-3 dB)	13 kHz (-3 dB)
Mechanical Filter Resonance	—	23 kHz	23 kHz	23 kHz
Resonant Frequency	≥ 200 kHz	≥ 100 kHz	≥ 100 kHz	≥ 100 kHz
Temperature Range	-65 to +200 °F -54 to +93 °C	0 to +150 °F -18 to +66 °C	0 to +150 °F -18 to +66 °C	0 to +150 °F -18 to +66 °C
Sensing Element	Ceramic/Shear	Ceramic/Shear	Ceramic/Shear	Ceramic/Shear
Electrical Connector	Integral Cable	Integral Cable	Integral Cable	Integral Cable
Electrical Ground Isolation	Yes	Yes	Yes	Yes
Housing Material	Titanium	Titanium	Titanium	Titanium
Sealing	Hermetic	Hermetic	Hermetic	Hermetic
Weight	4.4 gm	4.2 gm	4.5 gm	4.5 gm
Size	3/8 x 0.73 in 3/8 in x 18.4 mm	3/8 x 0.75 in 3/8 in x 19.1 mm	3/8 x 0.75 in 3/8 in x 19.1 mm	3/8 x 0.75 in 3/8 in x 19.1 mm
Mounting	1/4-28 Stud	1/4-28 Stud	1/4-28 Stud	1/4-28 Stud
Additional Version				
Metric Mounting Thread	M350B21	M350C02	M350B23	M350B24
Additional Accessories				
Adhesive Mounting Bases	080M217, M080M217	080M217, M080M217	080M217, M080M217	080M217, M080M217
Triaxial Mounting Adaptors	080A180, M080A180	080A180, M080A180	080A180, M080A180	080A180, M080A180
Mating Cable Connector	AL	AL	AL	AL
Connector Adaptor	070A02	070A02	070A02	070A02

Shock ICP® Accelerometers

Highlights

- Built-in Mechanical & Electrical Filters
- Lightweight Integral Cable or 10-32 Coaxial Jack
- Measurement Ranges From 5,000 g's to 100,000 g's



Shock Accelerometers			Triaxial Configuration	
				
Photos Shown Actual Size				
Model Number	350C03	350C04	350A14	350B50
Sensitivity	0.5 mV/g	1 mV/g	1 mV/g	0.5 mV/g
Measurement Range	± 10,000 g pk	± 5000 g pk	± 5000 g pk	± 10,000 g pk
Broadband Resolution	0.04 g rms	0.02 g rms	0.02 g rms	0.03 g rms
Frequency Range (± 1 dB)	0.4 to 10k Hz	0.4 to 10k Hz	0.4 to 7.5k Hz [1]	3 to 10k Hz
Electrical Filter Corner	13 kHz (-3dB)	13 kHz (-3dB)	7.5 kHz (-10%)	20 kHz (-3dB)
Mechanical Filter Resonance	23 kHz	23 kHz	—	—
Resonant Frequency	≥ 100 kHz	≥ 100 kHz	≥ 50 kHz	≥ 60 kHz
Temperature Range	0 to +150 °F -18 to +66 °C	0 to +150 °F -18 to +66 °C	-65 to +250 °F -54 to +121 °C	-65 to +250 °F -54 to +121 °C
Sensing Element	Ceramic/Shear	Ceramic/Shear	Quartz/Shear	Ceramic/Shear
Electrical Connector	10-32 Coaxial Jack	10-32 Coaxial Jack	10-32 Coaxial Jack	Integral Cable
Electrical Ground Isolation	No	No	No	Yes
Housing Material	Titanium	Titanium	Stainless Steel	Titanium
Sealing	Hermetic	Hermetic	Hermetic	Hermetic
Weight	4.5 gm	4.5 gm	17.9 gm	8.6 gm
Size	3/8 x 1.02 in 3/8 in x 25.9 mm	3/8 x 1.02 in 3/8 in x 25.9 mm	1/2 x 1.45 in 1/2 in x 36.8 mm	0.33 x 0.69 x 0.69 in 8.4 x 17.5 x 17.5 mm
Mounting	1/4-28 Stud	1/4-28 Stud	1/4-28 Stud	Through Hole
Additional Version				
Metric Mounting Thread	M350B03	M350B04	M350A14	—
Additional Accessories				
Adhesive Mounting Base	080M217, M080M217	080M217, M080M217	—	—
Triaxial Mounting Adaptor	080A180, M080A180	080A180, M080A180	—	—
Mating Cable Connectors	EB, AW	EB, AW	EB, AW	AY
Recommended Cables	002, 003 CE, 031 Flexible	002, 003 CE, 031 Flexible	002, 003 CE, 031 Flexible	034G05 (Included)
Note				
[1] Range shown is ± 10%				

Special Purpose Instruments



ICP® Mechanical Impedance Sensor

Model 288D01 Mechanical Impedance Sensor simultaneously measures an applied, driving-point force and response acceleration of a test structure for determining parameters such as mechanical mobility and mechanical impedance. The unit consists of a precision, shear mode accelerometer and a quartz force sensor in a common housing. Installation is primarily facilitated at the structural excitation points, in series with a stinger and vibration shaker.

Applications

- Structural Testing
- Modal Analysis

Highlights

- 100 mV/g [10.2 mV/(m/s²)] acceleration sensitivity
- 100 mV/lb [22.4 mV/N] force sensitivity
- 0.7 to 7000 Hz frequency range
- 19.2 gram weight



Portable 1g Handheld Shaker

Model 394C06 handheld shaker is a small, self-contained, battery powered, vibration exciter specifically designed to conveniently verify accelerometer and vibration system performance. It accepts sensors up to 210 grams* in weight and delivers a controlled, 1 G mechanical excitation. Ideal for conducting on-the-spot sensor sensitivity checks, identifying channels for multi-point data acquisition, performing end-to-end system troubleshooting, and confirming system gain settings.

**Total weight including mounting hardware and cable influence*

Highlights

- Provides mechanical excitation at 1 g rms or 1 g pk
- Fixed, 159.2 Hz frequency
- Powered by four "AA" alkaline batteries (included)
- Automatic shut-off for continuous operation
- Mechanical stops protect from overload
- Optional AC power adaptor (Model 073A16)
- Alternate Metric Model (M394C06) offers 10 m/sec² excitation



Back-to-back Comparison Calibration Standards

Back-to-back comparison calibration standard accelerometers permit NIST traceable calibration of accelerometers and other vibration sensors by the reference comparison method. The back-to-back reference calibration accelerometer is mounted to a mechanical exciter and the sensor to be calibrated is installed onto its surface. The output signals from the reference standard and transducer under test (TUT) are compared, permitting sensitivity, frequency response, and phase response verification of the tested unit. Frequency and amplitude inputs to the exciter can be varied to suit the desired test parameters. Included are interconnect cables and a dedicated signal conditioner for use with the reference standard to ensure a precise sensitivity at a common reference frequency. A variety of mounting studs and an NIST traceable calibration certificate are also provided. Readout instruments, shakers, and their controllers are not included.

Models

- Model 394A10, 1/4"-28 threaded, mounting hole
- Model 394A11, 10-32 threaded, mounting hole

Highlights

- 100 mV/g sensitivity
- 0.5 Hz to 10 kHz (± 5%) frequency range
- 85 to 264 VAC, 47 to 440 Hz powered
- Optional battery powered

Human Vibration Instruments



VibTrack HAV™

World's first self-contained finger-mounted personal dosimeter for hand-arm vibration. Inherently safe, and capable of measuring to AFG IH, ISO (5349), and ANSI (S2.70) standards. This miniature logging instrument provides continual data for over 12 hours of exposure under the most severe conditions.

Highlights

- Extremely compact & durable
- Measures vibration directly to ISO & ANSI standards
- Self-contained, finger mounted



Triaxial ICP® Seat Pad Accelerometer

Model 356B41 triaxial seat pad accelerometer measures whole body vibration influences associated with vehicle operation. The unit houses a triaxial accelerometer within a molded, rubber pad that can be placed under a seated person, beneath a weighted test object, or strapped onto the body.

Applications

- Operator Comfort Studies
- Construction Vehicle Vibration Exposure
- Seat Design Studies
- Seat Mounting, Suspension, Bracket, and Damping Tests

Highlights

- 100 mV/g [10.2 mV/(m/s²)] sensitivity
- 0.5 to 1000 Hz frequency range
- 180 gm weight
- 4-pin connector
- Supplied with Model 010G05 interface cable 5 ft (1.5 m) length to three BNC plugs



Human Vibration Meter

Model HVM-100 Human Vibration Meter utilizes accelerometer inputs to provide vibration severity measurements relative to human exposure to vibration. The unit is directly compatible with Model 356B41, triaxial seat pad accelerometer, as well as any other single axis or triaxial ICP® accelerometer.

Applications

- Hand-arm Vibration
- Whole-body Vibration
- Operator Comfort Studies

Highlights





- Data logging of rms, peak, and vector sum values
- RS-232 computer interface
- Programmable AC and DC outputs



Mounting Accessories

Adhesive Mounting Bases

Adhesive mounting bases are utilized to facilitate adhesively mounting an accelerometer to a test surface. The base is secured to the test object with a suitable adhesive such as epoxy, glue or wax. The accelerometer is then stud mounted to the adhesive mounting base. The use of the adhesive mounting base eliminates the adhesive from being in direct contact with the sensor and potentially clogging the tapped mounting hole. Accelerometers may be easily moved to multiple bases installed in various locations. All bases are machined of lightweight aluminum with a grooved side for applying the adhesive and a hardcoat finish which provides electrical isolation between the test object and the accelerometer. For proper mounting, match the hex size on the accelerometer to the hex size on the adhesive base. Use the next larger adhesive base hex size if a match is not available.

Adhesive Mounting Bases				
				
	Model 080A	Model 080A12	Model 080A178	Model 080A19
Model Number	Hex size	Thickness	Mounting	Material
080A14	5/16 in	0.32 in (8.1 mm)	10-32 Thread	Hardcoat Aluminum
M080A14	5/16 in	0.32 in (8.1 mm)	M5 x 0.8 Thread	Hardcoat Aluminum
080A15	5/16 in	0.125 in (3.18 mm)	5-40 Thread	Hardcoat Aluminum
M080A15	5/16 in	0.125 in (3.18 mm)	M3 x 0.50 Thread	Hardcoat Aluminum
080A04	3/8 in	0.200 in (5.08 mm)	10-32 Thread	Hardcoat Aluminum
M080A04	3/8 in	0.200 in (5.08 mm)	M6 x 0.75 Thread	Hardcoat Aluminum
080A25	7/16 in	0.125 in (3.18 mm)	5-40 Thread	Hardcoat Aluminum
M080A25	7/16 in	0.125 in (3.18 mm)	M3 x 0.50 Thread	Hardcoat Aluminum
080A178	1/2 in	0.120 in (3.05 mm)	10-32 Stud	Hardcoat Aluminum
080A	1/2 in	0.187 in (4.75 mm)	10-32 Thread	Hardcoat Aluminum
M080A	1/2 in	0.187 in (4.75 mm)	M6 x 0.75 Thread	Hardcoat Aluminum
080A145	3/4 in	0.200 in (5.08 mm)	5-40 Thread	Hardcoat Aluminum
080A12	3/4 in	0.200 in (5.08 mm)	10-32 Thread	Hardcoat Aluminum
M080A12	3/4 in	0.200 in (5.08 mm)	M6 x 0.75 Thread	Hardcoat Aluminum
080A13	3/4 in	0.200 in (5.08 mm)	1/4-28 Thread	Hardcoat Aluminum
080A19*	3/4 in	0.375 in (9.53 mm)	10-32 Thread	Hardcoat Aluminum
080A68	7/8 in	0.200 in (5.08 mm)	10-32 Thread	Hardcoat Aluminum
M080A68	7/8 in	0.200 in (5.08 mm)	M6 x 0.75 Thread	Hardcoat Aluminum
080A147	7/8 in	0.274 in (6.96 mm)	(2) M3 x 0.5 Thread	Hardcoat Aluminum
080A170	1.0 in	0.350 in (8.89 mm)	(2) 6-32 Thread	Hardcoat Aluminum
080A190	1.25 in	0.250 in (6.35 mm)	10-32 Thread	Stainless Steel
080M227*	1.15 in	0.625 in (15.9 mm)	10-32 Thread	Ceramic

* Suitable for use as a stud mounted, electrical isolation base with a 10-32 accelerometer mounting stud inserted into each end.

Mounting Pads for Array Accelerometers

Specially designed mounting pads are for use with array accelerometers that incorporate their electrical connection within their mounting surface.



Model	Cable Length
080B40	10 ft (3 m)
080B37	25 ft (7.6 m)
080B38	50 ft (15.2 m)

Mounting pad with 3-socket adhesive base with integral cable that terminates with a 3-socket IDC connector for use with Model 333B (available with BNC plug termination by specifying suffix / AC to model number, e.g., 080B40/AC)





Model 080A140
Mounting pad with 10-32 electrical connector for use with Model 333B31



Model 080A115
Mounting pad with integral 10 ft (3 m) cable and BNC plug termination for use with Model 333B31

Easy-mount Clips



Easy-Mount Clip			
	Models 080A160, 080A172, 080A173		Shown with sensor (sensor not included)
Model Number	080A172	080A173	080A160
Compatible Cube Size	0.40 in 10.2 mm	0.45 in 11.4 mm	0.55 in 14.0 mm
Size	0.55 x 0.55 x 0.25 in 14 x 14 x 6.4 mm	0.6 x 0.6 x 0.25 in 15.2 x 15.2 x 6.4 mm	0.81 x 0.81 x 0.32 in 20.6 x 20.6 x 8.1 mm
Weight	0.5 gm	0.6 gm	1.4 gm
Frequency Limit (± 5%) (Grease Mount)	2k Hz	2k Hz	2k Hz
Frequency Limit (± 10%) (Grease Mount)	4k Hz	3k Hz	2.5k Hz
Frequency Limit (± 5%) (Dry Mount)	1k Hz	1k Hz	1k Hz
Frequency Limit (± 10%) (Dry Mount)	1.3k Hz	1.3k Hz	1.3k Hz
Temperature Range (Continuous)	-65 to +125 °F -54 to +52 °C	-65 to +125 °F -54 to +52 °C	-65 to +125 °F -54 to +52 °C
High Temperature Limit (Short Term Exposure)	+175 °F +79 °C	+175 °F +79 °C	+175 °F +79 °C
Compatible Accelerometers	333B32, 333B33, 356B11, 356B21	333B42, 333B53, 356A12, 356A22	356A02, 356A15, 356A16, 356A17
Ordering Information			
100-Piece Bag of Easy-Mount Clips	080A181	080A183	080A185
Notes			
Actual attainable frequency limits may be higher than specified, particularly for lower weight accelerometers, and may differ depending on axis of motion. An interface of silicone grease between clip and accelerometer aids in mechanical coupling to improve attainable frequency range.			

Easy-mount clips offer practical and economical installation techniques for accelerometers in multi-channel vibration measurement applications.

The clips can be attached to the test structure via double sided tape or adhesive. Once the clips are installed, accelerometers are simply snapped into the clips and are ready to take vibration measurements.

More measurement points and orientations can be accommodated with fewer sensors by installing clips at all desired points and populating them with as many sensors as necessary. Sensors are then moved to remaining clip locations until all measurements are completed. Triaxial measurements can be made with single axis, cube-shaped accelerometers by changing axis orientation for successive measurements.

Swivel-style clips permit sensors installed on curved or sloped surfaces to be aligned along the desired plane and axis. These clips rotate and pivot to provide full flexibility in alignment.

Easy-Mount Swivel Clip			
	Models 080B174, 080B176, 080B177		Shown with sensor (sensor not included)
Model Number	080B174	080B176	080B177
Compatible Cube Size	0.40 in 10.2 mm	0.45 in 11.4 mm	0.55 in 14.0 mm
Size (Base Diameter x Maximum Height)	0.5 x 1.22 in 12.7 x 31.0 mm	0.5 x 1.22 in 12.7 x 31.0 mm	0.75 x 1.39 in 19.1 x 35.2 mm
Weight	3.6 gm	3.6 gm	5.5 gm
Frequency Limit (± 10%) (Grease Mount)	1k Hz	1k Hz	1k Hz
Temperature Range (Continuous)	-65 to +125 °F -54 to +52 °C	-65 to +125 °F -54 to +52 °C	-65 to +125 °F -54 to +52 °C
High Temperature Limit (Short Term Exposure)	+175 °F +79 °C	+175 °F +79 °C	+175 °F +79 °C
Compatible Accelerometers	333B32, 333B33, 356B11, 356B21	333B42, 333B53, 356A12, 356A22	356A02, 356A15, 356A16, 356A17
Ordering Information			
25-Piece Bag of Easy-Mount Swivel Clips	080B182	080B184	080B186
Notes			
Actual attainable frequency limits may be higher than specified, particularly for lower weight accelerometers, and may differ depending on axis of motion. An interface of silicone grease between clip and accelerometer aids in mechanical coupling to improve attainable frequency range.			

Adhesives

Many adhesives have been successfully used for securing mounting bases to test objects. These include epoxies, waxes, glues, gels, and dental cement. Some provide more permanent attachment than others. Stiffer adhesives provide better transmission of high frequencies. Adhesives should be selected which perform adequately for the required application and environmental conditions. PCB® offers petro wax and quick bonding gel.

Adhesives



Model 080A90
Quick Bonding Gel

Model 080A109
Petro Wax

Model Number	Description	Quantity Provided
080A24	Petro Wax	4 Squares, 1 x 1 x 0.25 in ea.
080A109	Petro Wax	1 Squares, 1 x 1 x 0.25 in
080A47	Petro Wax	175 gm Box
080A90	Quick Bonding Gel	1 Tube, 0.10 oz (3 gm)

Tips from Techs

How do I remove an adhesive mount sensor?

A debonder should always be used to avoid sensor damage.

To avoid damaging the accelerometer, a debonding agent must be applied to the adhesive prior to sensor removal. With so many adhesives in use (glues, dental cement, epoxies, etc.), there is no universal debonder available. The debonder for the Loctite 454 adhesive that PCB® offers is Acetone. If you are using anything other than Loctite 454, you will have to check with the individual manufacturer for the debonding recommendation. The debonding agent must be allowed to penetrate the surface in order to properly react with the adhesive, so it is advisable to wait a few minutes after applying before removing the sensor.

Tools

Removal tools help avoid sensor damage and assist with the removal of adhesively mounted “teardrop”-style accelerometers. The shear force applied, snaps the bond of most glues and epoxies.

Probe tips install onto accelerometers to enable their use as handheld vibration sensors. This technique is useful if installation space is severely limited or for determining installation locations where vibration is most prevalent.

Model Number	Applicable Sensor(s)
039A27	352A21, 352C22, 357A09, 357C10, 352A25
039A26	352C23, 352A73
039A28	352A24, 357A07
039A29	357A08, 357A19
039A07	740B02
039A31	352A56
039A32	352A71, 352A72
039A08	0.4 in (10.2 mm) Cube Shaped Accelerometers
039A09	0.45 in (11.4 mm) Cube Shaped Accelerometers
039A10	0.55 in (14 mm) Cube Shaped Accelerometers
039A12	0.8 in (20.3 mm) Cube Shaped Accelerometers
039A33	0.25 in (6.3mm) Cube Shaped Accelerometers



Model 080A09
Probe Tip with 10-32
tapped hole



Model 076A22
BNC connector tool
Helps grip BNC's for
connection to crowded panels



Removal tool for
cube shaped
accelerometers
**Models 039A08,
039A09, 039A10, &**







Removal tool for miniature
teardrop accelerometers
**Models 039A27,
039A26, 039A28, &**

Magnetic Mounting Bases

Magnetic mounting bases allow a convenient, temporary method of installing accelerometers to ferrous, magnetic surfaces. Select a magnetic base with a larger diameter than the accelerometer base.

Tips from Techs Always exercise caution when using a magnetic base, as the attractive installation forces can cause excessive shock to the sensor. It is recommended to install the magnet base to the test object on an edge and then "roll" the assembly gently into position; or install the magnet base to the test object first, and then attach the sensor.

Magnetic Mounting Bases





							
Model 080A30	Model 080A27	Model 080A179	Model 080A130, 131, 132	Model 080A54			
Model Number	Diameter	Thickness		Mounting	Force		Uses
080A30	3/8 in hex	0.23 in	5.84 mm	5-40 Thread	2.5 lb	11 N	Miniature, 2 gm Accelerometers
M080A30	3/8 in hex	0.2 in	5.08 mm	M3 x 0.5 Thread	2.5 lb	11 N	Miniature, 2 gm Accelerometers
080A27	3/4 in hex	0.27 in	6.86 mm	10-32 Stud	12 lb	54 N	General Purpose
080A179	0.75 in	0.40 in	10.2 mm	10-32 Thread	12 lb	54 N	General Purpose
080A54	1-3/8 in hex	0.49 in	12.45 mm	1/4-28 Stud	50 lb	225 N	Industrial Accelerometers
080A130	0.75 in	0.72 in	18.29 mm	1/4-28 Thread	15 lb	68 N	For Curved Surfaces
080A131	1.1 in	1.02 in	25.9 mm	1/4-28 Thread	35 lb	158 N	For Curved Surfaces
080A132	1.5 in	1.25 in	31.8 mm	1/4-28 Thread	55 lb	225 N	For Curved Surfaces

Mounting Studs and Screws

Mounting studs are used to secure the accelerometer to the test object. To ensure accurate measurements, always mount the accelerometer with the recommended mounting torque and avoid bottoming the stud into the test object's or accelerometer's tapped mounting hole. The use of a stud with

a shoulder will usually avoid bottoming, however, ensure that the base of the sensor is counter-bored to accept the shoulder. Once installed, the accelerometer's base should be in close contact with the test object surface.

Mounting Studs & Screws

					
Model 081A08	Model 081B05	Model 081B45	Model 081A21	Model 080A149	
Model Number	Mounting			Comment	Style
081A27	5-40 Stud	to	5-40 Stud	BeCu, For Some Triaxial Accelerometers	B
081A90	5-40 Stud	to	10-32 Stud	Adaptor Stud, BeCu	A
080A149	5-40 Thread	to	10-32 Stud	Adaptor Plate, 0.5" Dia. with 7/16" Flats	E
080A84	5-40 Thread	to	10-32 Stud	Adaptor Plate, 0.75" Dia. with Knurl	E
M080A149	M3 x 0.5 Thread	to	10-32 Stud	Adaptor Plate, 0.5" Dia. with 7/16" Flats	E
080A85	M3 x 0.5 Thread	to	10-32 Stud	Adaptor Plate, 0.75" Dia. with Knurl	E
080M260	6-32 Thread	to	10-32 Stud	Adaptor Plate, 0.75" Dia., Knurled with 5/8" Flats	E
081B05	10-32 Stud	to	10-32 Stud	with Shoulder, BeCu, For Most Accelerometers	B
081A21	10-32 Stud	to	10-32 Stud	Electrical Isolation Mounting Pad/Stud, 0.75" Hex	D
081C21	10-32 Stud	to	10-32 Stud	Electrical Isolation Mounting Pad/Longer Stud, 0.75" Hex	D
M081B23	10-32 Stud	to	M5 x 0.8 Stud	Adaptor Stud, BeCu	A
M081B05	10-32 Stud	to	M6 x 0.75 Stud	Adaptor Stud, with Shoulder, BeCu	A
M081A18	10-32 Stud	to	M6 x 1 Stud	Adaptor Stud, with Shoulder, Stainless Steel	A
081A08	10-32 Stud	to	1/4-28 Stud	Adaptor Stud, BeCu	A
081B20	1/4-28 Stud	to	1/4-28 Stud	With Shoulder, BeCu	B
081A96	1/4-28 Stud	to	1/4-28 Stud	Stainless Stl. for Model 350A96 Shock Accelerometer	B
M081B20	1/4-28 Stud	to	M6 x 0.75 Stud	Adaptor Stud, with Shoulder, BeCu	A
081B45	6-32 thd x 0.63 inch length	—	—	Cap Screw for Series 355 Ring Shaped Accelerometers	C
M081B45	M3 x 0.5 thd x 16 mm length	—	—	Cap Screw for Series 355 Ring Shaped Accelerometers	C
081B36	2-56 thd x 0.375 inch length	—	—	Cap Screw for 355B12 & 357A06	C
M081B36	M2 x 0.4 thd x 0.37 inch length	—	—	Cap Screw for 355B12 & 357A06	C
081B60	10-32 thd x 0.63 inch length	—	—	Cap Screw for 354C02 & 354C03	C

Triaxial Mounting Adaptors

Adapts three standard, single axis accelerometers for monitoring vibration in three orthogonal axes. Hex size listed represents the maximum allowable hex size for the installed single axis accelerometers.



Triaxial Mounting Bases



Style "A"



Style "B"



Style "C"

Model Number	Dimensions	Material	Mounting via	Accel. Fasteners	Max. Hex	Style
080B16	0.37 in (9.4 mm) Cube	Anodized Aluminum	10-32 Thread	5-40 Thread	5/16 in	A
M080B16	0.37 in (9.4 mm) Cube	Anodized Aluminum	10-32 Thread	M3 x 0.5 Thread	5/16 in	A
080A196	0.44 in (11.18 mm) Cube	Anodized Aluminum	10-32 Thread	5-40 Thread	3/8 in	A
080A17	0.812 in (20.62 mm) Cube	Stainless Steel	10-32 Screws	10-32 Thread	3/8 in	B
M080A17	0.812 in (20.62 mm) Cube	Stainless Steel	M5 x 0.8 Screws	M5 x 0.8 Thread	3/8 in	B
080B10	0.866 in (22 mm) Cube	Stainless Steel	8-36 Screws	10-32 Thread	1/2 in	B
M080B10	0.866 in (22 mm) Cube	Stainless Steel	M4 x 0.7 Screws	M6 x 0.75 Thread	1/2 in	B
080C10	0.866 in (22 mm) Cube	Anodized Aluminum	8-36 Screws	10-32 Thread	1/2 in	B
080A187	0.875 x 0.875 x 0.665 in (22.23 x 22.23 x 16.89 mm)	Anodized Aluminum	4-40 Screws	6-32 Thread	For Ring Type	C
080A180	1.00 in (25.4 mm) Cube	Titanium	10-32 Screws	1/4-28 Thread	7/8 in	C
M080A180	1.00 in (25.4 mm) Cube	Titanium	M5 x 0.8 Screws	M6 x 0.75 Thread	7/8 in	C
080B11	1.24 in (31.5 mm) Cube	Anodized Aluminum	10-32 Screws	10-32 Screws	7/8 in	B
M080B11	1.24 in (31.5 mm) Cube	Anodized Aluminum	M5 x 0.8 Screws	10-32 Screws	7/8 in	B
080A62	1.23 in (31.2 mm) Cube	Stainless Steel	10-32 Screws	1/4-28 Screws	7/8 in	B
080A57	1.48 in (37.6 mm) Cube	Stainless Steel	10-32 Screws	1/4-28 Screws	1-1/4 in	B
M080A57	1.48 in (37.6 mm) Cube	Stainless Steel	M5 x 0.8 Screws	1/4-28 Screws	1-1/4 in	B
Model	Dimensions	Material	Mounting via	Accel. Fasteners	Note	
080A194	0.28 in (7.11 mm) Cube	Anodized Aluminum	Adhesive	Adhesive	For Teardrop Accelerometers	
080A114	0.90 in (22.86 mm) Cube	Aluminum	10-32 Thread	10-32 Electrical Jack	Use Only with Models 333B31, 333B41 or 333B51	
080A153	1.265 in (32.13 mm) Cube	Acetal	10-32 Thread	4-40 Screws	Use with Series 3711	
080A208	1.01 in (25.65 mm) Cube	Anodized Aluminum	6-32 Screws	4-40 Screws	Use with Series 3741	
080A204	1.23 in (31.2 mm) Cube	Anodized Aluminum	10-32 Screws	10-32 Thread	Use with 393B04 or B05	
080A213	0.6 x 0.8 0.36 in (15.2 x 20.3 x 9.1 mm)	Titanium	8-32 Screws	4-40 Screws	Use with Series 3991	

Impact Hammers

Highlights

- Modally Tuned® to provide more consistent results
- Variety of hammers to suit any size test object
- Assortment of tips offer frequency tailored impulse

Each PCB® Modally Tuned®, ICP® instrumented impact hammer features a rugged, force sensor that is integrated into the hammer's striking surface.

“Modal Tuning” is a feature that ensures the structural characteristics of the hammer do not affect measurement results. This is accomplished by eliminating hammer resonances in the frequency range of interest from corrupting the test data, resulting in more accurate and consistent measurements.

The force sensor serves to provide a measurement of the amplitude and frequency content of the energy stimulus that is imparted to a test object. Accelerometers are used in conjunction with the hammer to provide a measurement of the object's structural response due to the hammer blow. A variety of tips supplied with each hammer permit the energy content of the force impulse to be tailored to suit the requirements of the item under test.

Using multi-channel data acquisition and analysis software, the test engineer is able to ascertain a variety of mechanical properties leading to an understanding of an object's structural behavioral characteristics. Items analyzed can include resonance detection, mode shapes, transfer characteristics, and structural health – such as crack and fatigue detection.

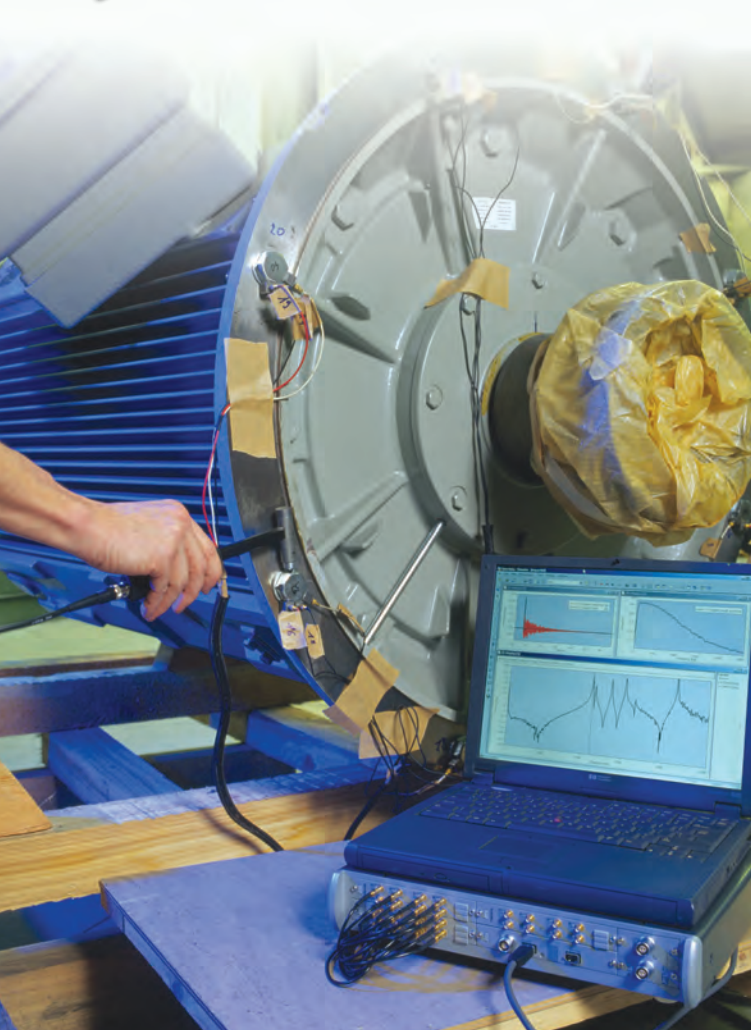

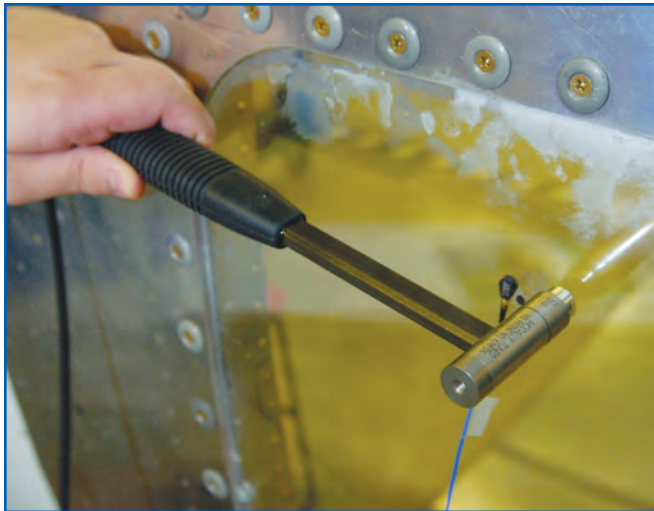

Impact Hammers

Applications

- Structure Health Testing
- Resonance Determination
- Modal Analysis

Impact Hammers			
Model Number	086E80	086C01	086C03
Sensitivity	100 mV/lbf 22.5 mV/N	50 mV/lbf 11.2 mV/N	10 mV/lbf 2.25 mV/N
Measurement Range	± 50 lbf pk ± 220 N pk	± 100 lbf pk ± 440 N pk	± 500 lbf pk ± 2200 N pk
Resonant Frequency	≥ 100 kHz	≥ 15 kHz	≥ 22 kHz
Sensing Element	Quartz	Quartz	Quartz
Sealing	Epoxy	Epoxy	Epoxy
Hammer Mass	4.8 gm	100 gm	160 gm
Head Diameter	0.25 in 6.3 mm	0.62 in 1.57 cm	0.62 in 1.57 cm
Tip Diameter	0.10 in 2.5 mm	0.25 in 6.3 mm	0.25 in 6.3 mm
Hammer Length	4.2 in 107 mm	8.5 in 21.6 cm	8.5 in 21.6 cm
Electrical Connection Position	Bottom of Handle	Bottom of Handle	Bottom of Handle
Extender Mass Weight	1.25 gm	25 gm	75 gm
Electrical Connector	5-44 Coaxial Jack	BNC Jack	BNC Jack
Supplied Accessories			
Mounting Stud	—	(2) 081B05	(2) 081B05
Extender Mass	084A13	084A06	084A08
Hard Tip	—	084B03	084B03
Medium Tip	—	084B04	084B04
Soft Tip	—	(2) 084C05	(2) 084C05
Super Soft Tip	—	(2) 084C11	(2) 084C11
Tip Cover	084A28	(2) 085A10	(2) 085A10
NIST Calibration	HCS-2	HCS-2	HCS-2
Cable	018G10	—	—
Wax	080A109	—	—
Plastic Handle	084A14	—	—
Aluminum Handle	084A17	—	—
Additional Version			
Alternative Sensitivity	—	—	086C04 - 5 mV/lbf

Tips from Techs

How do I know which impact hammer to select for my application?

The general rule of thumb to follow is the larger the structure to excite, the larger the impact hammer required. Some selection guidelines are as follows:

086E80 - Printed Circuit Boards & Hard Drives

086C01 - Lightly Damped Panels & Frames

086C02, C03, & C04 - Medium sized structures such as Car Frames, Engines, & Machined Parts

086D05 - Heavier sized components such as Pumps & Compressors

086D20 - Heavy Structures such as Tool Foundations & Storage Tanks

086D50 - Large Structures such as Buildings, Bridges, & Ships

Impact Hammers

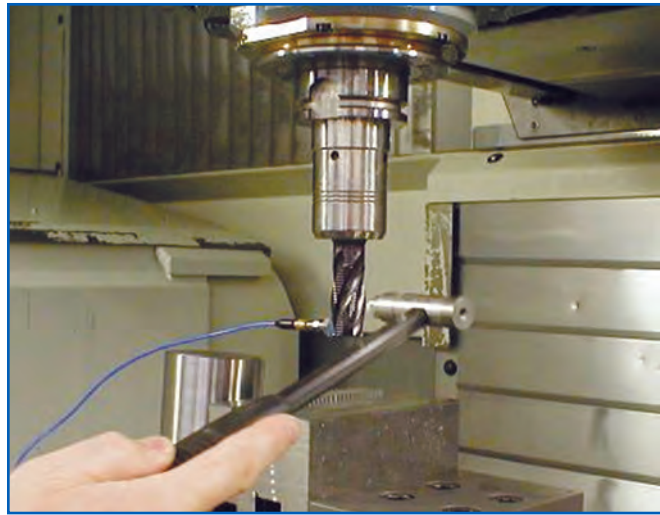

Impact Hammers

CE



Model Number	086D05	086D20	086D50
Sensitivity	1 mV/lbf 0.23 mV/N	1 mV/lbf 0.23 mV/N	1 mV/lbf 0.23 mV/N
Measurement Range	± 5000 lbf pk ± 22,240 N pk	± 5000 lbf pk ± 22,240 N pk	± 5000 lbf pk ± 22,240 N pk
Resonant Frequency	≥ 22 kHz	≥ 22 kHz	≥ 5 kHz
Sensing Element	Quartz	Quartz	Quartz
Sealing	Epoxy	Hermetic	Hermetic
Hammer Mass	0.32 kgm	1.1 kgm	5.5 kgm
Head Diameter	1.0 in 2.5 cm	2.0 in 5.1 cm	3.0 in 7.6 cm
Tip Diameter	0.25 in 0.63 cm	2.0 in 5.1 cm	3.0 in 7.6 cm
Hammer Length	9.0 in 22.7 cm	14.5 in 37 cm	35 in 89 cm
Electrical Connection Position	Bottom of Handle	Bottom of Handle	Bottom of Handle
Extender Mass Weight	200 gm	—	—
Electrical Connector	BNC Jack	BNC Jack	BNC Jack
Supplied Accessories			
Mounting Stud	(2) 081B05	—	—
Extender Mass	084A09	—	—
Hard Tip	084B03	084A63	084A32
Medium Tip	084B04	084A62	—
Soft Tip	(2) 084C05	084A61	084A31
Super Soft Tip	084A50	084A60	—
Tip Cover	(2) 085A10	—	—
NIST Calibration	HCS-2	HCS-2	HCS-2

Microphones & Preamplifiers

Applications

- Noise, Vibration and Harshness (NVH) Testing
- Environmental Noise Analysis
- Sound Power Testing
- Transfer Path Analysis
- Sound Pressure Mapping
- General Noise Reduction

The identification of noise sources is necessary to evaluate and reduce noise levels. "Noise" denotes unwanted sound, and hence, the need to negate these sounds and vibrations. Vibrations above and below a specific range may not be detectable to the human ear, but may still require treatments for improved product performance and longevity. The frequency of the noise is paramount, as it dictates which method of treatment or what material will work best.

As alternatives to intensity measurements, acoustic array techniques are currently being evaluated. Often, when a method is found to provide useful information for one test object in one environment, an attempt is made to apply it in situations where it is not necessarily advantageous. Unfortunately, there does not appear to be a single method of source identification that is easy, quick and accurate for all applications. This is why PCB® offers a variety of acoustic measurement products, including condenser, modern prepolarized, traditional externally polarized, array, probe, low-profile surface, and special purpose microphones. PCB® Microphone products are complemented by an assortment of preamplifiers, signal conditioners, A-weighting filters, handheld calibrators, and accessories.

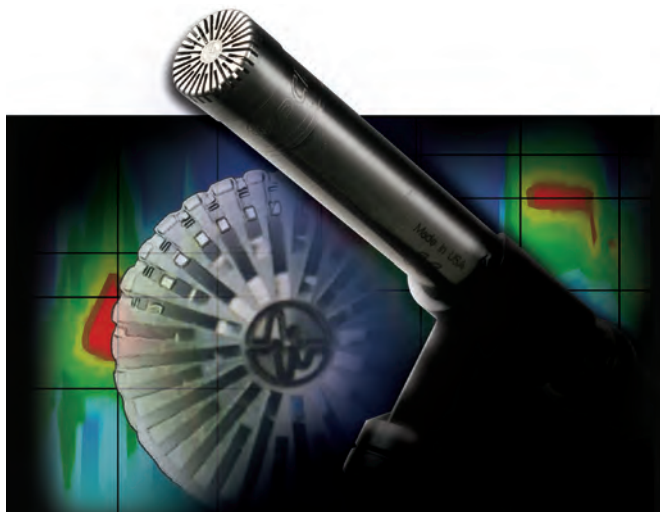

Model 377B02 (Shown with Preamplifier Accessory)



Microphone Comparison

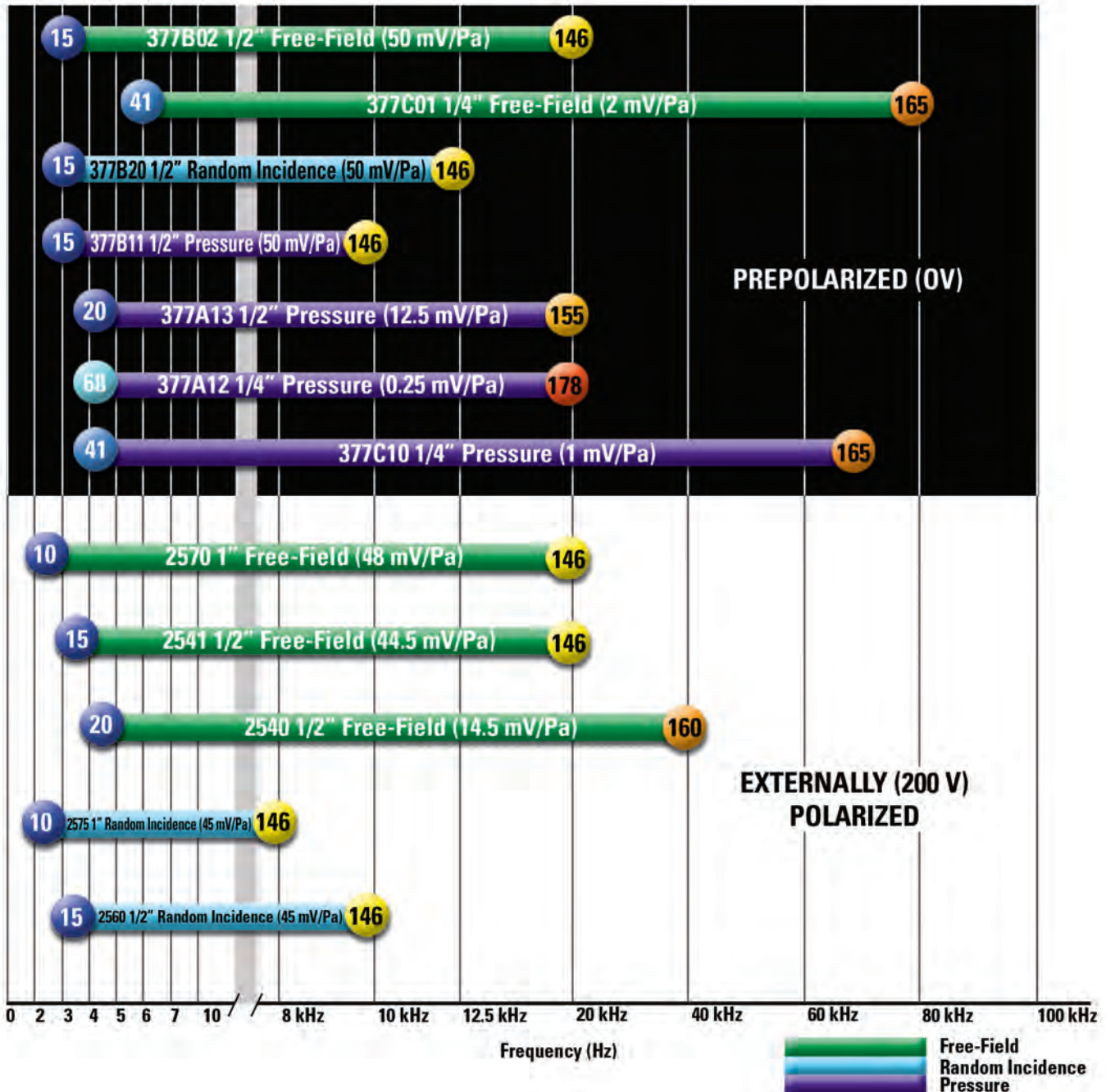
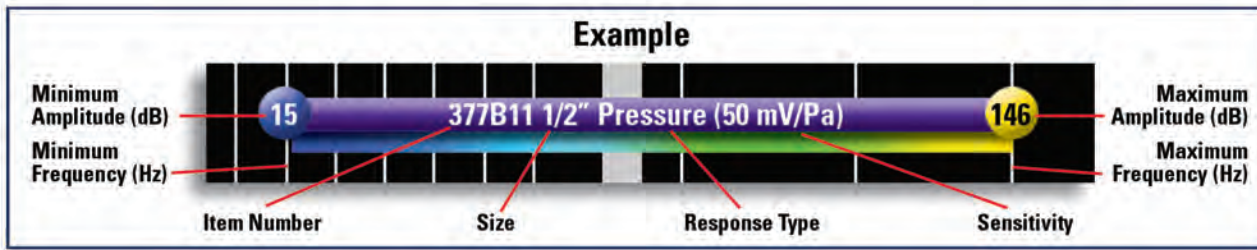

See page 157 for definitions.



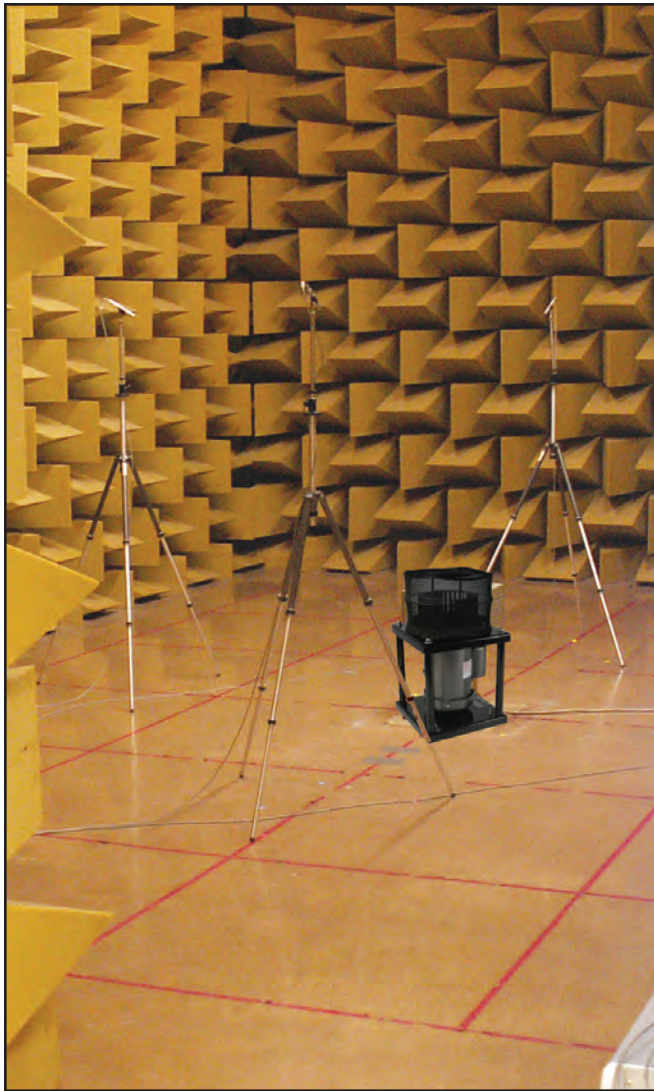



Prepolarized (OV) Condenser Microphones



Highlights

- Modern design
- Operates from ICP® sensor power
- Low cost per channel
- IEC “Type 1” compliant models
- Uses coaxial cables with BNC or 10-32 connections
- Interchangeable with ICP® style accelerometers and pressure sensors

Prepolarized (OV) Precision Condenser Microphone Cartridges

							
Model Number	377C01	377C10	377A12	377B02	377B11	377A13	377B20
Diameter	1/4 inch	1/4 inch	1/4 inch	1/2 inch	1/2 inch	1/2 inch	1/2 inch
Response	Free-Field	Pressure	Pressure	Free-Field	Pressure	Pressure	Random Incidence
Open Circuit Sensitivity	2 mV/Pa	1 mV/Pa	0.25 mV/Pa	50 mV/Pa	50 mV/Pa	12.5 mV/Pa	50 mV/Pa
Frequency Range (± 2 dB)	5.4 to 80k Hz	4 to 70k Hz	4 to 20k Hz	3.15 to 20k Hz	3.15 to 10k Hz	4 to 20k Hz	3.14 to 12.5k Hz
Dynamic Range - 3% Distortion Limit [1]	165 dB	165 dB	178 dB	146 dB	146 dB	155 dB	146 dB
Dynamic Range - Cartridge Thermal Noise [1]	41 dBA	41 dBA	68 dBA	15 dBA	15 dBA	20 dBA	15 dBA
Temperature Range	-40 to +248 °F -40 to +120 °C	-40 to +248 °F -40 to +120 °C	-40 to +248 °F -40 to +120 °C	-40 to +248 °F -40 to +120 °C	-40 to +248 °F -40 to +120 °C	-40 to +248 °F -40 to +120 °C	-40 to +248 °F -40 to +120 °C
Note							
[1] re 20 µPa							

Externally Polarized (200V) Condenser Microphones

Highlights

- Operates from 200V power
- Large assortment of sizes and models
- IEC "Type 1" compliant models
- Interchangeable with existing competitive models

Externally polarized microphones utilize a 200V power supply. Original models were popular due to their low noise characteristics, but technological advances over the years have allowed the standard 0V designs to meet or even exceed the low noise floor system specifications of the 200V units.







Externally polarized microphones have the capability of going to a higher +302 °F (+150 °C) temperature, than its prepolarized + 248 °F (+120 °C) counterpart. However, since these microphones require a preamplifier, it is the preamplifier specification that is the limiting factor in the operating temperature capability and the system must be viewed in total.

Externally polarized microphones require a separate 200V power supply and 7-pin cabling, which tends to make the system cost-per-channel much greater, even though the microphone itself is cost effective when compared to the prepolarized models.

are using and already have the cabling and 200V power supplies, or because a certain special model or size is only available in a 200V design.



Externally Polarized (200V) Precision Condenser Microphone Cartridges

							
Model Number	2520	2540	2559	2541	2560	2570	2575
Diameter	1/4 inch	1/2 inch	1/2 inch	1/2 inch	1/2 inch	1 inch	1 inch
Response	Free-Field	Free-Field	Random Incidence	Free-Field	Random Incidence	Free-Field	Random Incidence
Open Circuit Sensitivity	4 mV/Pa	14.5 mV/Pa	12.9 mV/Pa	44.5 mV/Pa	45.2 mV/Pa	48 mV/Pa	45 mV/Pa
Frequency Range (± 2 dB)	4 to 80k Hz	4 to 40k Hz	4 to 25k Hz	3.15 to 20k Hz	2.6 to 10k Hz	2.6 to 20k Hz	2.6 to 8000 Hz
Dynamic Range - 3% Distortion Limit [1]	164 dB	160 dB	160 dB	146 dB	146 dB	146 dB	146 dB
Dynamic Range - Cartridge Thermal Noise [1]	30 dBA	20 dBA	160 dB	15 dBA	15 dBA	10 dBA	10 dBA
Temperature Range	-40 to +302 F -40 to +150 C	-40 to +302 °F -40 to +150 °C	-40 to +302 F -40 to +150 C	-40 to +302 °F -40 to +150 °C	-40 to +302 °F -40 to +150 °C	-40 to +302 °F -40 to +150 °C	-40 to +302 °F -40 to +150 °C
Note							
[1] re 20 µPa							

For additional product specifications visit www.larsondavis.com

Preamplifiers for Prepolarized & Externally Polarized Microphones

PCB® designs and manufactures ICP® preamplifiers for prepolarized microphones as well as traditional preamplifiers for use with externally polarized microphones. Small and rugged, with a low noise floor and a large dynamic range, these stainless steel preamplifiers are required for accurate testing.

The **industry exclusive** Model HT426E01 high temperature microphone preamplifier is designed to overcome specific high temperature challenges.

Model HT378B02, is PCB's high-value/high-temperature acoustic system which includes a preamplifier (Model HT426E01) and a microphone (Model 377B02).



Highlights:

- Low noise
- Low attenuation to microphone sensitivity
- Large assortment of sizes and models
- IEC "Type 1" compliant models
- Wide temperature range



Preamplifiers							
	Prepolarized					Externally Polarized	
Model Number	426B03	426E01	HT426E01	426A10	426A11	426A30	426B31
Diameter	1/4 inch	1/2 inch	1/2 inch	1/2 inch	1/2 inch	1/2 inch	1/4 inch
Gain (Attenuation)	-0.08 dB [1]	-0.05 dB [1]	-0.06 dB [2]	-0.1 dB [1]	-0.16 dB [1]	-0.2 dB [1]	-0.14 dB [3]
Frequency Response (± 0.1 dB)	5 to 126k Hz	6.3 to 125k Hz	6.3 to 126k Hz	80 to 125k Hz	5 to 125k Hz	10 to 126k Hz	10 to 126k Hz
Electrical Noise (A-weight)	≤ 3.2 µV [1]	≤ 2.8 µV [1]	≤ 4.9 µV [2]	≤ 3.6 µV	≤ 7.5 µV [1]	≤ 2.8 µV [1]	≤ 4.8 µV [3]
Electrical Noise (Linear)	≤ 5.6 µV [1]	≤ 5 µV [1]	≤ 13.4 µV [2]	≤ 11.2 µV [1]	≤ 5.7 µV [1]	≤ 5 µV [1]	≤ 12 µV [3]
Output Voltage (Maximum)	± 8 V pk	± 7 V pk	± 7 V pk	± 7 V pk	± 5 V pk	± 14 V pk	± 25 V pk
Temperature Range	-40 to +158 °F -40 to +70 °C	-40 to +176 °F -40 to +80 °C	-40 to +248 °F -40 to +120 °C	-40 to +176 °F -40 to +80 °C	-4 to +158 °F -20 to +70 °C	-40 to +185 °F -40 to +85 °C	-4 to +167 °F -20 to +75 °C
Output Connector	10-32 Coaxial Jack	BNC Jack	BNC Jack	BNC Jack	BNC Jack	7-Pin	Integral Cable with 7-Pin
TEDS IEEE P1451.4	Yes	Yes	Yes	Yes	Yes	No	Yes

Notes
 [1] Measured with an 18 pF reference microphone. [2] Measured with a 12 pF reference microphone [3] Measured with a 6.8 pF reference microphone

TEDS Microphone & Preamplifier Systems, IEEE 1451.4 Compliant							
Mated System Pair	377C01 426B03	377B02 426E01	377B02 HT426E01	377B11 426E01	377A13 426E01	377B20 426E01	
TEDS Version 0.9	378C01	378B02	HT378B02	378B11	378A13	378B20	
TEDS Version 1.0	TLD378C01	TLD378B02	HTTLD378B02	TLD378B11	TLD378A13	TLD378B20	

Array Style Microphones

Highlights

- Modern prepolarized (0V) design
- Operates from ICP® sensor power
- Low cost-per-channel
- Uses coaxial cables with BNC, SMB, or 10-32 connections
- Interchangeable with ICP® style accelerometers and pressure sensors

Applications

- Holography
- Beamforming
- General Audible Range Testing
- Sound Pressure Mapping
- Preventative Maintenance
- Machinery Monitoring

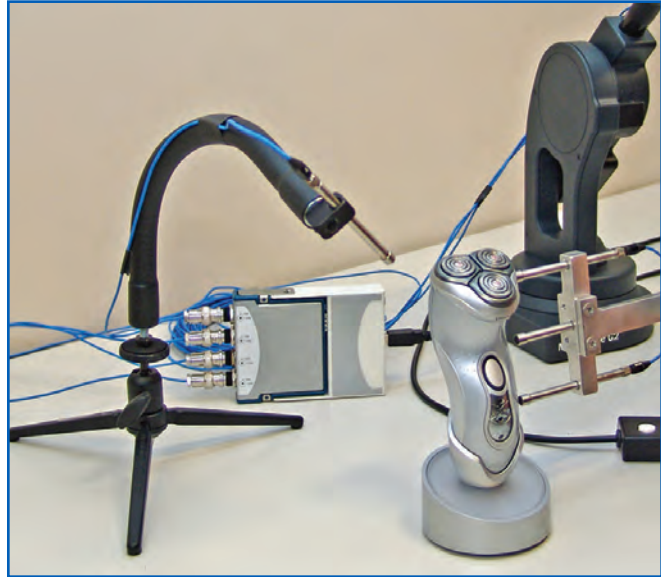

The PCB® Series 130 ICP® array microphones offer a cost effective solution for large channel count sound pressure measurements and general audible range testing.

The modern prepolarized design allows for the use of any 2- 20 mA constant current supply to power the sensors.

Three different connector configurations are available: BNC, 10-32 and SMB. The slim design of PCB® Models 130E21 and 130E22 offer minimal reflections of the sound waves and are the preferred choice of large channel count systems, while Model 130E20 offers an ergonomic design and utilizes cost effective BNC connectors.

Each of these microphones include TEDS programming, version 1.0 which is IEEE 1451.4 compliant.

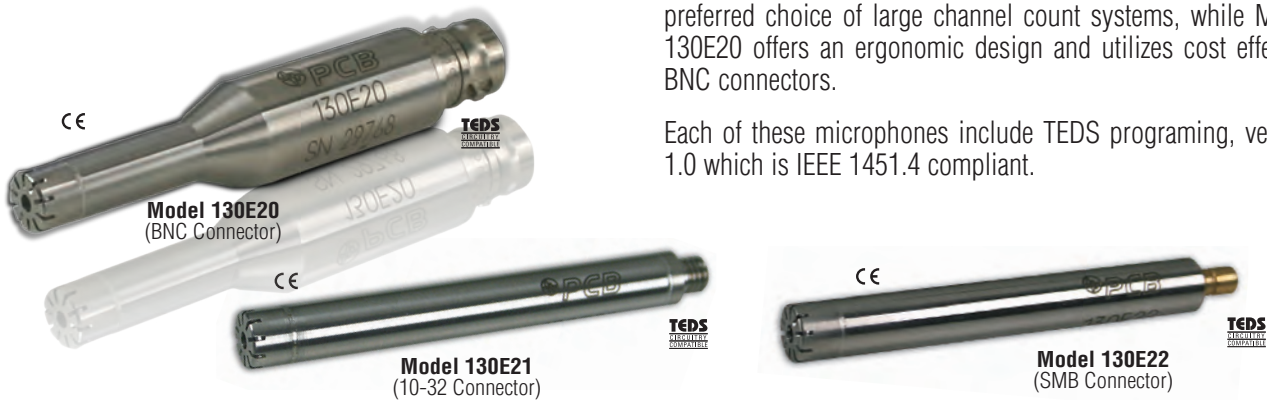

ICP® Array Microphones with Integral Preamplifier			
Model Number	130E20	130E21	130E22
Microphone Diameter	1/4 in	1/4 in	1/4 in
Response	Free-Field	Free-Field	Free-Field
Sensitivity (± 3 dB at 250 Hz)	45 mV/Pa	45 mV/Pa	45 mV/Pa
Frequency Response (± 2 dB)	20 to 10k Hz	20 to 10k Hz	20 to 10k Hz
Frequency Response (± 5 dB)	20 to 20k Hz	20 to 20k Hz	20 to 20k Hz
Dynamic Range	< 30 to > 122 dB	< 30 to > 122 dB	< 30 to > 122 dB
Polarization Voltage	0 V	0 V	0 V
Temperature Range	+14 to +122 °F -10 to +55 °C	+14 to +122 °F -10 to +55 °C	+14 to +122 °F -10 to +55 °C
Connector	BNC Jack	10-32 Jack	SMB Socket
TEDS IEEE 1451.4	Included	Included	Included

High Temperature Probe Microphone

Model 377A26 probe microphones are compact units designed for use in difficult measurement situations, such as those found in small cavities, harsh environments, and high temperatures. The acoustic signal is guided to the microphone through a detachable, stainless-steel probe. The high acoustic input impedance of the probe tip minimizes its influence on the acoustic field. Probe microphones are internally compensated to equalize the static pressure at the probe tip with the internal microphone pressure.



Model 426B02
A-weighting Filter

In-line “A-weighting” Filter

Model 426B02 In-line A-weighting Filter is powered by constant current excitation and is compatible with ICP® microphone preamplifiers. When using this filter, however, a minimum of 4 mA excitation current is required of the ICP® sensor signal conditioner or readout device, which incorporates ICP® sensor power.

Acoustic Accessories



ADP043

ADP009

ADP008

079A24

079A29

Adaptors

ADP043 – 1/4 inch Microphone to 1/2 inch Preamplifier Adaptor

ADP009 – 1/2 inch Microphone to 1/4 inch Preamplifier Adaptor

ADP008 – 1 inch Microphone to 1/2 inch Preamplifier Adaptor

079A24 – Tripod Stand Adaptor to Convert 5/8 inch Stud to 1/4 inch For Microphone Holder

079A29 – Swivel Head, Stand to Holder Adaptor



EXA010

003C10

003D10

003U10

003V10

Cables (Additional Lengths Available)

EXA010 – 10 Foot Cable with 7 Pin Connectors

003C10 – 10 Foot Coaxial Cable with 10-32 Plug and BNC Plug

003D10 – 10 Foot Coaxial Cable with BNC Plugs

003U10 – 10 Foot Coaxial Cable with SMB Plugs

003V10 – 10 Foot Coaxial Cable with SMB Plug and BNC Plug

Acoustic Accessories

Calibration Equipment



CAL200 – 1 kHz, 94 and 114 dB, Calibrator

ADP024 – CAL200 to 1/4 inch Microphone Adaptor

CAL250 – 250 Hz, 94 dB Calibrator

ADP021 – CAL250 to 1/4 inch Microphone Adaptor

079A31 – 8-Channel Coupler for the CAL250 Calibrator

394A40 – 250 Hz, 94 dB Pistonphone Calibrator

079A30 – Pistonphone to 1 inch Microphone Adaptor

Environmental Protection



079A07 – 3-1/2 in Windscreen for 1/4 inch Microphone

079A06 – 3-1/2 in Windscreen for 1/2 inch Microphone

079B20 – Nose Cone for 1/4 inch Microphone

079B21 – Nose Cone for 1/2 inch Microphone

EPS2106 – Short Term Outdoor Protection, 3/4 inch Mount

EPS2108 – Short Term Outdoor Protection, 1/4 inch Side Exit Mount

Holders



079A10 – Holder for 1/4 inch Microphone

079A11 – Holder for 1/2 inch Microphone

079B23 – Holder for Both 1/4 inch and 1/2 inch Microphone

079A32 – Clip Holder for 1/4 inch Microphone

Stands and Mounts



079A15 – Tripod Stand with Boom Arm

079B16 – Miniature Tripod Stand with Adjustable Legs

079A17 – Camera Tripod Stand

079A18 – Adjustable Clamp

Piezoelectric, Quartz Pressure Sensors for Dynamic Pressure Measurements

Highlights

- Fast, micro-second response time
- Resonant frequency to ≥ 500 kHz
- Measure small pressure changes at high static pressure levels
- Operating temperature range from -320 to $+750$ °F (-196 to $+399$ °C)
- Rugged solid state construction withstands shock and vibration to thousands of G's
- ICP® amplified output for "dirty" or underwater environments can be transmitted through long, ordinary coaxial cable without loss of signal strength or an increase in noise

The PCB® full line of piezoelectric pressure sensors are used for a variety of dynamic pressure measurements. Some examples include: compression, pulsations, surges, cavitation, hydraulic and pneumatic pressure fluctuations, high-intensity sound, fluid borne noise detection, shock and blast waves, ballistics, explosive component testing (e.g. detonators, explosive bolts), closed bomb combustion studies, and other dynamic pressures from <0.0001 psi to $>100,000$ psi (<0.690 Pa to >690 MPa).

The ability to measure small pressure fluctuations at high static pressure levels is a unique characteristic of piezoelectric pressure sensors. With ICP® amplified output, the sensors are well suited for continuous operation in "dirty" environments, underwater, and in field test applications across long cables. Since special low-noise cable and charge amplifiers are not required, ICP® sensor systems are substantially lower in cost per channel. Because of the ICP® sensor's low impedance output, superior signal-to-noise ratio, ability to drive long low-cost coaxial cables, they are ideal for virtually all dynamic pressure applications where sensor temperatures range from -320 to $+275$ °F (-196 to $+135$ °C). For higher temperature applications, charge output sensors are available for use up to $+750$ °F ($+399$ °C).

Although piezoelectric pressure sensors are primarily recommended for dynamic pressure measurements, some quartz pressure sensors have long discharge time constants that extend low-frequency capability to permit static calibration and measurement of quasi-static pressures over a period of a few seconds.



Solid state construction of a piezoelectric pressure sensor allows for a wide linear measuring range such that PCB® confidently provides calibrations at 100% and 10% of full scale output for most models. Multiple strain gage or Piezoresistive type sensors, with their narrow measuring ranges, would be required to make the range of measurements possible with a single quartz piezoelectric sensor.

Standard or specialized sensors and mounting adaptors can be provided to facilitate sensor installation in existing mounting ports.

To discuss specific applications, or if a special pressure sensor or adaptor is required, please contact PCB® for assistance.

General Purpose Pressure Sensors for High Frequency

TipsTechs

When calibrating in air or other gas, apply grease to the diaphragm to avoid false data caused by thermal shock.

Applications

- Combustion Studies
- Explosive Component Testing (e.g. detonators, explosive bolts)
- Airbag Testing
- Measurement of air blast shock waves

PCB® dynamic pressure sensors set the standard for extremely fast, micro-second response with a wide amplitude and frequency range. These characteristics allow them to excel in high-frequency applications, where minimum sensor diameter is required.

General Purpose Pressure Sensors for High Frequency

				
Model Number	113B28	113B27	113B21	113B26
Measurement Range	50 psi 344.7 kPa	100 psi 690 kPa	200 psi 1379 kPa	500 psi 3450 kPa
Useful Overrange [1]	100 psi 690 kPa	200 psi 1379 kPa	400 psi 2758 kPa	1 kpsi 6895 kPa
Sensitivity	100 mV/psi 14.5 mV/kPa	50 mV/psi 7.25 mV/kPa	25 mV/psi 3.6 mV/kPa	10 mV/psi 1.45 mV/kPa
Maximum Pressure	1 kpsi 6895 kPa	1 kpsi 6895 kPa	1 kpsi 6895 kPa	10 kpsi 68,950 kPa
Resolution	1 mpsi 0.007 kPa	1 mpsi 0.007 kPa	1 mpsi 0.007 kPa	2 mpsi 0.014 kPa
Resonant Frequency	≥ 500 kHz	≥ 500 kHz	≥ 500 kHz	≥ 500 kHz
Rise Time (Reflected)	≤ 1 μsec	≤ 1 μsec	≤ 1 μsec	≤ 1 μsec
Low Frequency Response (-5 %)	0.5 Hz	0.5 Hz	0.5 Hz	0.01 Hz
Non-linearity [2]	≤ 1 %	≤ 1 %	≤ 1 %	≤ 1 %
Acceleration Sensitivity	≤ 0.002 psi/g ≤ 0.0014 kPa/(m/s ²)	≤ 0.002 psi/g ≤ 0.0014 kPa/(m/s ²)	≤ 0.002 psi/g ≤ 0.0014 kPa/(m/s ²)	≤ 0.002 psi/g ≤ 0.0014 kPa/(m/s ²)
Temperature Range	-100 to +275 °F -73 to +135 °C	-100 to +275 °F -73 to +135 °C	-100 to +275 °F -73 to +135 °C	-100 to +275 °F -73 to +135 °C
Discharge Time Constant	≥ 1 sec	≥ 1 sec	≥ 1 sec	≥ 50 sec
Electrical Connector	10-32 Coaxial Jack	10-32 Coaxial Jack	10-32 Coaxial Jack	10-32 Coaxial Jack
Housing Material	17-4 PH Stainless Steel	17-4 PH Stainless Steel	17-4 PH Stainless Steel	17-4 PH Stainless Steel
Diaphragm Material	Invar	Invar	Invar	Invar
Sealing	Welded Hermetic	Welded Hermetic	Welded Hermetic	Welded Hermetic
Supplied Accessories				
Seal Rings	(3) 065A02, 065A05 Steel	(3) 065A02, 065A05 Steel	(3) 065A02, 065A05 Steel	(3) 065A02, 065A05 Steel
Clamp Nuts	060A03, 060A05			
Additional Versions				
All Invar Material	113B38	113B37	113B31	113B36
Low Cost	—	111A21	—	111A26
Stainless Diaphragm	S113B28	S113B27	S113B281	S113B26
Low Cost Stainless Diaphragm	—	—	—	S111A26
Additional Accessories				
Installation Tooling Kits	040A10 (English), 040A11 (Metric)			
Mounting Adaptors	061A01 (3/8-24), 061A10 (M10), 062A01 (1/8-27NPT), 061A59 (3/8-24 Offground), 064B02 (1/2-20 Water Cooled)			
Mating Cable Connector	EB			
Recommended Cables	002, 003 CE			
Notes				
[1] For +10 volt output, minimum 24 VDC supply voltage required. Negative 10 volt output may be limited by output bias. [2] Zero-based, least-squares, straight line method.				



Photo Courtesy of Peerless Mfg. Co.



Highlights

- Fast rise time $\leq 1 \mu\text{sec}$ from quartz element
- Ultra-high resonant frequency of $\geq 500 \text{ kHz}$
- Frequency-tailored output without the “ringing” characteristic of most other sensors
- Internal acceleration compensation minimizes shock and vibration sensitivity

General Purpose Pressure Sensors for High Frequency

	CE			
				
Model Number	113B24	113B22	113B23	113B03
Measurement Range	1 kpsi 6895 kPa	5 kpsi 34,475 kPa	10 kpsi 68,950 kPa	15 kpsi 103,420 kPa
Useful Overrange [1]	2 kpsi 13,790 kPa	10 kpsi 68,950 kPa	—	—
Sensitivity	5 mV/psi 0.725 mV/kPa	1 mV/psi 0.145 mV/psi	0.5 mV/psi 0.073 mV/kPa	0.4 pC/psi 0.06 pC/kPa
Maximum Pressure	10 kpsi 68,950 kPa	15 kpsi 103,420 kPa	15 kpsi 103,420 kPa	15 kpsi 103,420 kPa
Resolution	5 mpsi 0.035 kPa	20 mpsi 0.14 kPa	40 mpsi .28 kPa	10 mpsi [3] 0.07 kPa [3]
Resonant Frequency	$\geq 500 \text{ kHz}$	$\geq 500 \text{ kHz}$	$\geq 500 \text{ kHz}$	$\geq 500 \text{ kHz}$
Rise Time (Reflected)	$\leq 1 \mu\text{sec}$	$\leq 1 \mu\text{sec}$	$\leq 1 \mu\text{sec}$	$\leq 1 \mu\text{sec}$
Low Frequency Response (-5 %)	0.005 Hz	0.001 Hz	0.0005 Hz	—
Non-linearity [2]	$\leq 1 \%$	$\leq 1 \%$	$\leq 1 \%$	$\leq 1 \%$
Acceleration Sensitivity	$\leq 0.002 \text{ psi/g}$ $\leq 0.0014 \text{ kPa}/(\text{m/s}^2)$	$\leq 0.002 \text{ psi/g}$ $\leq 0.0014 \text{ kPa}/(\text{m/s}^2)$	$\leq 0.002 \text{ psi/g}$ $\leq 0.0014 \text{ kPa}/(\text{m/s}^2)$	$\leq 0.002 \text{ psi/g}$ $\leq 0.0014 \text{ kPa}/(\text{m/s}^2)$
Temperature Range	-100 to +275 °F -73 to +135 °C	-100 to +275 °F -73 to +135 °C	-100 to +275 °F -73 to +135 °C	-400 to +400 °F -240 to +204 °C
Discharge Time Constant	$\geq 100 \text{ sec}$	$\geq 500 \text{ sec}$	$\geq 1000 \text{ sec}$	—
Electrical Connector	10-32 Coaxial Jack	10-32 Coaxial Jack	10-32 Coaxial Jack	10-32 Coaxial Jack
Housing Material	17-4 PH Stainless Steel	17-4 PH Stainless Steel	17-4 PH Stainless Steel	17-4 PH Stainless Steel
Diaphragm Material	Invar	Invar	Invar	Invar
Sealing	Welded Hermetic	Welded Hermetic	Welded Hermetic	Welded Hermetic
Supplied Accessories				
Seal Rings	(3) 065A02, 065A05 Steel	(3) 065A02, 065A05 Steel	(3) 065A02, 065A05 Steel	(3) 065A02, 065A05 Steel
Clamp Nuts	060A03, 060A05			
Additional Versions				
All Invar Material	113B34	113B32	113B33	—
Low Cost	111A24	111A22	111A23	—
Stainless Diaphragm	S113B24	S113B22	S113B23	—
Low Cost Stainless Diaphragm	S111A24	S111A22	S111A23	—
Additional Accessories				
Installation Tooling Kits	040A10 (English), 040A11(Metric)			
Mounting Adaptors	061A01 (3/8-24), 061A10 (M10), 062A01 (1/8-27NPT), 061A59 (3/8-24 Offground), 064B02 (1/2-20 Water Cooled)			
Mating Cable Connector	EB			
Recommended Cables	002, 003 CE			
Notes				
[1] For +10 volt output, minimum 24 VDC supply voltage required. Negative 10 volt output may be limited by output bias. [2] Zero-based, least-squares, straight line method. [3] Resolution dependent on range setting and cable length used in charge system				

Ground Isolated ICP® Pressure Sensors for High Frequency

From Techs

Ground isolation prevents 50/60 Hz noise and ground loops.

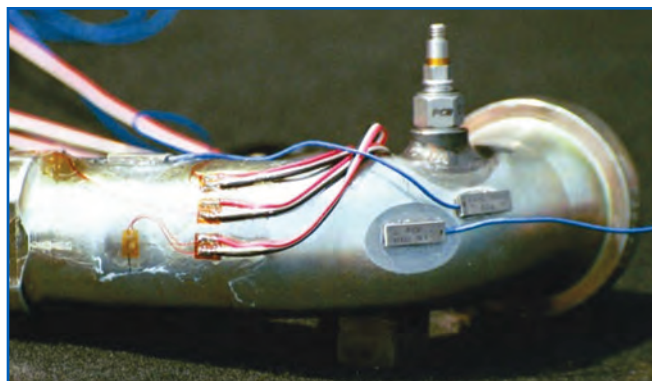

Ground Isolated ICP® Pressure Sensors for High Frequency



Model Number	102B18	102B16	102B15	102B06
Measurement Range	50 psi 344.7 kPa	100 psi 690 kPa	200 psi 1379 kPa	500 psi 3450 kPa
Useful Overrange [1]	100 psi 690 kPa	200 psi 1379 kPa	400 psi 2758 kPa	1 kpsi 6895 kPa
Sensitivity	100 mV/psi 14.5 mV/kPa	50 mV/psi 7.25 mV/kPa	25 mV/psi 3.6 mV/kPa	10 mV/psi 1.45 mV/kPa
Maximum Pressure	1 kpsi 6895 kPa	1 kpsi 6895 kPa	1 kpsi 6895 kPa	10 kpsi 68,950 kPa
Resolution	1 mpsi 0.007 kPa	1 mpsi 0.007 kPa	1 mpsi 0.007 kPa	2 mpsi 0.014 kPa
Resonant Frequency	≥ 500 kHz	≥ 500 kHz	≥ 500 kHz	≥ 500 kHz
Rise Time (Reflected)	≤ 1 μsec	≤ 1 μsec	≤ 1 μsec	≤ 1 μsec
Low Frequency Response (-5 %)	0.5 Hz	0.5 Hz	0.5 Hz	0.01 Hz
Non-linearity [2]	≤ 1 %	≤ 1 %	≤ 1 %	≤ 1 %
Acceleration Sensitivity	≤ 0.002 psi/g ≤ 0.0014 psi/(m/s ²)	≤ 0.002 psi/g ≤ 0.0014 psi/(m/s ²)	≤ 0.002 psi/g ≤ 0.0014 psi/(m/s ²)	≤ 0.002 psi/g ≤ 0.0014 psi/(m/s ²)
Temperature Range	-100 to +275 °F -73 to +135 °C	-100 to +275 °F -73 to +135 °C	-100 to +275 °F -73 to +135 °C	-100 to +275 °F -73 to +135 °C
Discharge Time Constant	≥ 1 sec	≥ 1 sec	≥ 1 sec	≥ 50 sec
Electrical Connector	10-32 Coaxial Jack	10-32 Coaxial Jack	10-32 Coaxial Jack	10-32 Coaxial Jack
Housing Material	17-4 PH Stainless Steel	17-4 PH Stainless Steel	17-4 PH Stainless Steel	17-4 PH Stainless Steel
Diaphragm Material	Invar	Invar	Invar	Invar
Sealing	Welded Hermetic	Welded Hermetic	Welded Hermetic	Welded Hermetic
Supplied Accessories				
Seal Rings	(3) 065A03	(3) 065A03	(3) 065A03	(3) 065A03
Additional Versions				
Metric Mounting Thread	M102B18	M102B16	M102B15	M102B06
Low Cost	—	101A05	—	101A06
Low Cost Stainless Diaphragm	—	S101A05	—	S101A06
Low Cost Metric Mount	—	M101A05	—	M101A06
Ablative Coated Diaphragm	CA102B18	—	CA102B15	CA102B06
Additional Accessories				
Mating Cable Connector	EB	EB	EB	EB
Recommended Cables	002, 003 CE	002, 003 CE	002, 003 CE	002, 003 CE
Notes				
[1] For +10 volt output, minimum 24 VDC supply voltage required. Negative 10 volt output may be limited by output bias. [2] Zero-based, least-squares, straight line method				



PCB® Series 102B is a ground isolated version of the Series 113B. These sensors have all of the same features and benefits of the 113B Series, plus the added benefit of isolation, which helps prevent ground loop problems. This series can accommodate an optional ablative coating (Prefix: CA) to protect the diaphragm from thermal shock in flash-temperature applications.



Ablative coating option 'CA' is available for flash protection.

Ground Isolated ICP® Pressure Sensors for High Frequency

Model Number	102B04	102B	102B03
Measurement Range	1 kpsi 6,900 kPa	5 kpsi 34,540 kPa	10 kpsi 69,000 kPa
Useful Overrange [1]	2 kpsi 13,790 kPa	10 kpsi 69,000 kPa	—
Sensitivity	5 mV/psi 0.725 mV/kPa	1 mV/psi 0.15 mV/kPa	0.5 mV/psi 0.07 mV/kPa
Maximum Pressure	10 kpsi 69,000 kPa	15 kpsi 103,400 kPa	15 kpsi 103,420 kPa
Resolution	20 mpsi 0.138 kPa	20 mpsi 0.14 kPa	40 mpsi 0.28 kPa
Resonant Frequency	≥ 500 kHz	≥ 500 kHz	≥ 500 kHz
Rise Time (Reflected)	≤ 1 μsec	≤ 1 μsec	≤ 1 μsec
Low Frequency Response (-5 %)	0.005 Hz	0.001 Hz	0.0005 Hz
Non-linearity [2]	≤ 1 %	≤ 1 %	≤ 1 %
Acceleration Sensitivity	≤ 0.002 psi/g ≤ 0.0014 psi/(m/s ²)	≤ 0.002 psi/g ≤ 0.0014 psi/(m/s ²)	≤ 0.002 psi/g ≤ 0.0014 psi/(m/s ²)
Temperature Range	-100 to +275 °F -73 to +135 °C	-100 to +275 °F -73 to +135 °C	-100 to +275 °F -73 to +135 °C
Discharge Time Constant	≥ 100 sec	≥ 500 sec	≥ 1000 sec
Electrical Connector	10-32 Coaxial Jack	10-32 Coaxial Jack	10-32 Coaxial Jack
Housing Material	17-4 PH Stainless Steel	17-4 PH Stainless Steel	17-4 PH Stainless Steel
Diaphragm Material	Invar	Invar	Invar
Sealing	Welded Hermetic	Welded Hermetic	Welded Hermetic
Supplied Accessories			
Seal Rings	(3) 065A03	(3) 065A03	(3) 065A03
Additional Versions			
Metric Mounting Thread	M102B04	M102B	M102B03
Low Cost	101A04	101A02	101A03
Stainless Diaphragm	—	S102B	—
Low Cost Stainless Diaphragm	—	—	S101A03
Ablative Coating	CA102B04	CA102B	CA102B03
Low Cost Metric Mount	M101A04	M101A02	M101A03
Additional Accessories			
Mating Cable Connector	EB	EB	EB
Recommended Cables	002, 003 CE	002, 003 CE	002, 003 CE
Notes			

[1] For +10 volt output, minimum 24 VDC supply voltage required. Negative 10 volt output may be limited by output bias. [2] Zero-based, least-squares, straight line method

Sub-Miniature ICP® Pressure Sensors

Highlights:

- Integral machined diaphragm for long life
- Fast rise time of $\leq 2 \mu\text{sec}$ from quartz element
- High resonant frequency of $\geq 250 \text{ kHz}$

PCB® dynamic pressure sensors are designed for applications where mounting is strictly limited. Excellent for cavitation studies with a robust, solid diaphragm design.



Sub-miniature ICP® Pressure Sensors

Model Number	105C02	105C12	105C22
Measurement Range	100 psi 690 kPa	1 kpsi 6895 kPa	5 kpsi 34,475 kPa
Sensitivity	50 mV/psi 7.3 mV/kPa	5 mV/psi 0.73 mV/kPa	1 mV/psi 0.145 mV/kPa
Maximum Pressure	250 psi 1720 kPa	2 kpsi 13,790 kPa	7.5 kpsi 51,710 kPa
Resolution	5 mpsi 0.035 kPa	20 mpsi 0.14 kPa	100 mpsi 0.69 kPa
Resonant Frequency	$\geq 250 \text{ kHz}$	$\geq 250 \text{ kHz}$	$\geq 250 \text{ kHz}$
Rise Time (Reflected)	$\leq 2 \mu\text{sec}$	$\leq 2 \mu\text{sec}$	$\leq 2 \mu\text{sec}$
Low Frequency Response (-5 %)	0.5 Hz	0.5 Hz	0.5 Hz
Non-linearity [1]	$\leq 2 \%$	$\leq 2 \%$	$\leq 2 \%$
Acceleration Sensitivity	$\leq 0.04 \text{ psi/g}$ $\leq 0.028 \text{ psi/(m/s}^2\text{)}$	$\leq 0.04 \text{ psi/g}$ $\leq 0.028 \text{ psi/(m/s}^2\text{)}$	$\leq 0.04 \text{ psi/g}$ $\leq 0.028 \text{ psi/(m/s}^2\text{)}$
Temperature Range	-100 to +250 °F -73 to +121 °C	-100 to +250 °F -73 to +121 °C	-100 to +250 °F -73 to +121 °C
Discharge Time Constant	$\geq 1 \text{ sec}$	$\geq 1 \text{ sec}$	$\geq 1 \text{ sec}$
Electrical Connector	5-44 Coaxial Jack	5-44 Coaxial Jack	5-44 Coaxial Jack
Housing Material	17-4 PH Stainless Steel	17-4 PH Stainless Steel	17-4 PH Stainless Steel
Diaphragm Material	17-4 PH Stainless Steel	17-4 PH Stainless Steel	17-4 PH Stainless Steel
Sealing	Welded Hermetic	Welded Hermetic	Welded Hermetic
Supplied Accessories			
Mating Cable	018C10	018C10	018C10
Installation Tool	040A37	040A37	040A37
Seal Rings	(3) 065A10, (3) 065A38	(3) 065A10, (3) 065A38	(3) 065A10, (3) 065A38
Additional Version			
Metric Mount	M105C02	M105C12	M105C22
Additional Accessories			
English Installation Kit	040A33	040A33	040A33
Metric Installation Kit	040A34	040A34	040A34
Mating Cable Connector	AG	AG	AG
Recommended Stock Cables	002, 003 CE	002, 003 CE	002, 003 CE
Note			
[1] Zero-based, least-squares, straight line method			

High Sensitivity Pressure Sensors

Highlights:

- Fast rise time of $\leq 2 \mu\text{sec}$ from quartz element
- High resonant frequency of $\geq 250 \text{ kHz}$
- Contains a rigid, multi-plate quartz element for high output
- Internal acceleration compensation minimizes vibration sensitivity

High sensitivity ICP® pressure sensors are a popular choice for low pressure measurements requiring excellent resolution and small size. PCB® Series 112A pressure sensors are used to measure small dynamic hydraulic and pneumatic pressures such as turbulence, noise, sound, and pulsations, especially in adverse environments. They are capable of measuring high-intensity sound pressures from 111 to 210 dB at any static pressure level from full vacuum to 1,000 psi (6,895 kPa).

High Sensitivity Pressure Sensors			
			
Model Number	112A22	112A21	112A03
Measurement Range	50 psi 345 kPa	100 psi 690 kPa	10 kpsi 68,950 kPa
Useful Overrange [1]	100 psi 690 kPa	200 psi 1380 kPa	—
Sensitivity	100 mV/psi 14.5 mV/kPa	50 mV/psi 7.25 mV/kPa	1.1 pC/psi 0.16 pC/kPa
Maximum Pressure (Static)	500 psi 3450 kPa	1 kpsi 6895 kPa	15 kpsi 103,420 kPa
Resolution	0.1 mpsi 0.0007 kPa	0.4 mpsi 0.0028 kPa	2 mpsi [3] 0.014 kPa [3]
Resonant Frequency	$\geq 250 \text{ kHz}$	$\geq 250 \text{ kHz}$	$\geq 250 \text{ kHz}$
Rise Time (Reflected)	$\leq 2 \mu\text{sec}$	$\leq 2 \mu\text{sec}$	$\leq 2 \mu\text{sec}$
Low Frequency Response (-5 %)	0.5 Hz	0.5 Hz	—
Non-linearity [2]	$\leq 1 \%$	$\leq 1 \%$	$\leq 1 \%$
Acceleration Sensitivity	$\leq 0.002 \text{ psi/g}$ $\leq 0.0014 \text{ psi/(m/s}^2\text{)}$	$\leq 0.002 \text{ psi/g}$ $\leq 0.0014 \text{ psi/(m/s}^2\text{)}$	$\leq 0.002 \text{ psi/g}$ $\leq 0.0014 \text{ psi/(m/s}^2\text{)}$
Temperature Range	-100 to +275 °F -73 to +135 °C	-100 to +275 °F -73 to +135 °C	-400 to +400 °F -240 to +204 °C
Discharge Time Constant	$\geq 1 \text{ sec}$	$\geq 1 \text{ sec}$	—
Electrical Connector	10-32 Coaxial Jack	10-32 Coaxial Jack	10-32 Coaxial Jack
Housing Material	17-4 PH Stainless Steel	17-4 PH Stainless Steel	17-4 PH Stainless Steel
Diaphragm Material	Invar	Invar	Invar
Sealing	Welded Hermetic	Welded Hermetic	Welded Hermetic
Supplied Accessories			
Clamp Nuts	(1) 060A03, 060A05	(1) 060A03, 060A05	(1) 060A03, 060A05
Seal Rings	(3) 065A02, 065A05	(3) 065A02, 065A05	(3) 065A02, 065A05
Additional Versions			
Ground Isolated	102A07	102A05	—
Ablative Coating	CA102A07	CA102A05	—
Stainless Diaphragm	S112A22	S112A21	S112A03
Additional Accessories			
English Installation Tooling Kit	040A10	040A10	040A10
Metric Installation Tooling Kit	040A11	040A11	040A11
Mounting Adaptors	061A01, 061A10, 062A01, 061A59, 064B02	061A01, 061A10, 062A01, 061A59, 064B02	061A01, 061A10, 062A01, 061A59, 064B02
Mating Cable Connector	EB	EB	EB
Recommended Cables	002, 003 CE	002, 003 CE	003
Notes			
[1] For +10 volt output, minimum 24 VDC supply voltage required. Negative 10 volt output may be limited by output bias. [2] Zero-based, least-squares, straight line method.			

High Sensitivity ICP® Acoustic Pressure Sensors





Highlights

- Capable of high-intensity sound measurement of 191 dB with 86 dB resolution
- Acceleration compensated, ceramic element virtually eliminates vibration sensitivity

PCB® Series 103B has played a major role in the development of supersonic aircraft and rockets. This tiny instrument is also useful for measuring transient pressure events, air turbulence, and other such acoustic phenomena on structures or aerodynamic models.

High Sensitivity ICP® Acoustic Pressure Sensors

				
Model Number	103B01	103B11	103B02	103B12
Measurement Range	3.3 psi 181 dB	10 psi 190.7 dB	3.3 psi 181 dB	10 psi 191 dB
Useful Overrange [1]	6.7 psi 187 dB	20 psi 196.7 dB	6.7 psi 187 dB	20 psi 197 dB
Sensitivity	1500 mV/psi 217.5 mV/kPa	500 mV/psi 72.5 mV/kPa	1500 mV/psi 217.5 mV/kPa	500 mV/psi 72.5 mV/kPa
Maximum Dynamic Pressure Step	250 psi [4] 1725 kPa	250 psi [4] 1725 kPa	250 psi [4] 1725 kPa	250 psi [4] 1725 kPa
Resolution	0.02 mpsi 77 dB	0.06 mpsi 86 dB	0.02 mpsi 77 dB	0.06 mpsi 86 dB
Resonant Frequency	≥ 13 kHz	≥ 13 kHz	≥ 13 kHz	≥ 13 kHz
Rise Time (Reflected)	≤ 25 μsec	≤ 25 μsec	≤ 25 μsec	≤ 25 μsec
Low Frequency Response (-5 %)	5 Hz	5 Hz	5 Hz	5 Hz
Non-linearity [2]	≤ 2 %	≤ 2 %	≤ 2 %	≤ 2 %
Acceleration Sensitivity	≤ 0.0005 psi/g ≤ 0.0035 psi/(m/s ²)	≤ 0.0005 psi/g ≤ 0.0035 psi/(m/s ²)	≤ 0.0005 psi/g ≤ 0.0035 psi/(m/s ²)	≤ 0.0005 psi/g ≤ 0.0035 psi/(m/s ²)
Temperature Range	-100 to +250 °F -73 to +121 °C	-100 to +250 °F -73 to +121 °C	-100 to +250 °F -73 to +121 °C	-100 to +250 °F -73 to +121 °C
Discharge Time Constant(at room temp)	≥ 0.1 sec	≥ 0.1 sec	≥ 0.1 sec	≥ 0.1 sec
Electrical Connector	Integral Cable	Integral Cable	10-32 Coaxial Jack	10-32 Coaxial Jack
Housing Material	Stainless Steel	Stainless Steel	Stainless Steel	Stainless Steel
Diaphragm Material	316 Stainless Steel	316 Stainless Steel	316 Stainless Steel	316 Stainless Steel
Sealing	Epoxy	Epoxy	Welded Hermetic	Welded Hermetic
Supplied Accessories				
Adhesive Mounting Ring	(3) 065A66	(3) 065A66	(3) 065A66	(3) 065A66
Sleeve Clamp	061A04	061A04	—	—
English Clamp Nut	—	—	060A10	060A10
Metric Clamp Nut	—	—	060A24	060A24
Seal Rings	—	—	(3) 160-0242-00	(3) 160-0242-00
Additional Versions				
Side Connector	—	—	103B03	103B13
Metric Mount	M103B01	M103B11	M103B02	M103B12
Additional Accessories				
Mating Cable Connector	EB	EB	EB	EB
Recommended Cables	002, 003 CE	002, 003 CE	002, 003 CE	002, 003 CE
Notes				
[1] For +10 volt output, minimum 24 VDC supply voltage required. Negative 10 volt output may be limited by output bias. [2] Zero-based, least-squares, straight line method				

High Sensitivity ICP® Acoustic Pressure Sensors

FAQ

Q: How do I calibrate?

A: In a Model 915A01 pistonphone.

Highlights

- Ability to measure small pressure changes ≤ 0.1 mpsi (0.689 Pa) under high static conditions
- Acceleration compensated virtually eliminates vibration sensitivity
- Ground isolation is available with plastic hardware

High Sensitivity ICP® Acoustic Pressure Sensors

CE



CE



Model Number	106B52	106B50	106B
Measurement Range	1 psi 6.89 kPa	5 psi 34.45 kPa	8.3 psi [2] 57.2 kPa [2]
Sensitivity	5000 mV/psi 725 mV/kPa	500 mV/psi 72.5 mV/kPa	300 mV/psi 43.5 mV/kPa
Maximum Dynamic Pressure Step	10 psi 68.9 kPa	100 psi 690 kPa	200 psi 1379 kPa
Maximum Static Pressure	50 psi 345 kPa	500 psi 3448 kPa	2 kpsi 13,790 kPa
Resolution	0.02 mpsi 0.00013 kPa	0.07 mpsi 0.00048 kPa	0.1 mpsi 0.00069 kPa
Resonant Frequency	≥ 40 kHz	≥ 40 kHz	≥ 60 kHz
Rise Time (Reflected)	≤ 12.5 μ sec	≤ 12.5 μ sec	≤ 9 μ sec
Low Frequency Response (-5 %)	2.5 Hz	0.5 Hz	0.5 Hz
Non-linearity [1]	≤ 1 %	≤ 1 %	≤ 1 %
Acceleration Sensitivity	≤ 0.002 psi/g ≤ 0.0014 psi/(m/s ²)	≤ 0.002 psi/g ≤ 0.0014 psi/(m/s ²)	≤ 0.002 psi/g ≤ 0.0014 psi/(m/s ²)
Temperature Range	-65 to +250 °F -54 to +121 °C	-65 to +250 °F -54 to +121 °C	-65 to +250 °F -54 to +121 °C
Discharge Time Constant	≥ 0.2 sec	≥ 1 sec	≥ 1 sec
Electrical Connector	10-32 Coaxial Jack	10-32 Coaxial Jack	10-32 Coaxial Jack
Housing Material	17-4 PH Stainless Steel	17-4 PH Stainless Steel	304/304L Stainless Steel
Diaphragm Material	316 Stainless Steel	316 Stainless Steel	316 Stainless Steel
Sealing	Welded Hermetic	Welded Hermetic	Welded Hermetic
Supplied Accessories			
English Clamp Nut	060A11	060A11	060A12
Metric Clamp Nut	060A13	060A13	060A14
Seal Rings	(3) 065A36	(3) 065A36	065A37
Additional Accessories			
Pipe Thread Adaptor	062A07	062A07	062A06
English Thread Adaptor	—	—	061A60
Ground Isolated Adaptor, English Thread	061A65	061A65	061A61
Water Cooled Adaptor	064A07	064A07	064B06
Mating Cable Connector	EB	EB	EB
Recommended Cables	002, 003 CE	002, 003 CE	002, 003 CE

Notes

[1] Zero-based, least-squares, straight line method. [2] 2.5 Volt Output.

Extreme Environment Dynamic Pressure Sensors

PCB® Cryogenic Series 102A

Highlights

- Fast rise time of $\leq 2 \mu\text{sec}$ from quartz element, with high resonant frequency $\geq 250 \text{ kHz}$
- Welded, hermetically sealed, stainless steel construction
- Electrically ground isolated, which helps prevent ground loop challenges
- Calibration supplied at room temperature with thermal coefficients at $-320 \text{ }^\circ\text{F}$ ($-196 \text{ }^\circ\text{C}$)

PCB® Cryogenic quartz dynamic pressure sensors are a high-resolution ICP® pressure sensor design, specially made for cryogenic environments. They consistently follow dynamic events found in cryogenic turbo pumps for liquid fuel handling systems or biomedical research.



PCB® High Temperature Series 112A & 116B

Highlights

- Laser welded, hermetically sealed quartz sensing elements
- Fused ceramic insulation connectors
- Internal acceleration compensation minimizes vibration sensitivity
- Calibration supplied at room temperature with thermal coefficients up to $+750 \text{ }^\circ\text{F}$ ($+399 \text{ }^\circ\text{C}$)

PCB® High Temperature quartz dynamic pressure sensors are designed for operation at the highest temperatures. They are structured with quartz crystals and operate, without cooling, up to $+750 \text{ }^\circ\text{F}$ ($+399 \text{ }^\circ\text{C}$) on compressors and pumps. Special mounting adaptors can be supplied to fit existing mounting holes. Water cooled adaptors are available to provide a lower temperature thermally stable environment that allow sensors to operate in applications above their normal operating range.

Hard-line cables are recommended for operating temperatures above $+500 \text{ }^\circ\text{F}$ ($+260 \text{ }^\circ\text{C}$). The cable can be welded to the sensor for operation in pressurized environments. All of these features ensure reliable operation in high temperature environments.





Extreme Environment Pressure Sensors

Extreme Environment Pressure Sensors	Cryogenic		High Temperature		
Model Number	102A10	102A14	112A05	116B	116B03
Measurement Range	100 psi 690 kPa	5 kpsi 34,475 kPa	5 kpsi 34,475 kPa	100 psi 690 kPa	100 psi 690 kPa
Useful Overrange [1]	200 psi 1380 kPa	10 kpsi 68,950 kPa	—	—	—
Sensitivity	50 mV/psi [4] 7.25 mV/kPa [4]	1 mV/psi [4] 0.145 mV/kPa [4]	1.1 pC/psi 0.16 pC/kPa	6 pC/psi 0.87 pC/kPa	6 pC/psi 0.87 pC/kPa
Maximum Pressure (Static)	15 kpsi 103,425 kPa	15 kpsi 103,425 kPa	10 kpsi 68,950 kPa	3 kpsi 20,685 kPa	3 kpsi 20,685 kPa
Resolution	2 mpsi 0.014 kPa	100 mpsi 0.69 kPa	4 mpsi [3] 0.028 kPa [3]	0.3 mpsi [3] 0.0021 kPa [3]	0.3 mpsi [3] 0.0021 kPa [3]
Resonant Frequency	≥ 250 kHz	≥ 250 kHz	≥ 200 kHz	≥ 55 kHz	≥ 55 kHz
Rise Time (Reflected)	≤ 2 μsec	≤ 2 μsec	≤ 2 μsec	≤ 9 μsec	≤ 9 μsec
Low Frequency Response (-5 %)	0.5 Hz	0.25 Hz	—	—	—
Non-linearity [2]	≤ 1 %	≤ 1 %	≤ 1 %	≤ 1 %	≤ 1 %
Acceleration Sensitivity	≤ 0.002 psi/g ≤ 0.0014 psi/(m/s ²)	≤ 0.002 psi/g ≤ 0.0014 psi/(m/s ²)	≤ 0.003 psi/g ≤ 0.0021 psi/(m/s ²)	≤ 0.002 psi/g ≤ 0.0014 psi/(m/s ²)	≤ 0.002 psi/g ≤ 0.0014 psi/(m/s ²)
Temperature Range	-320 to +212 °F -196 to +100 °C	-320 to +212 °F -196 to +100 °C	-400 to +600 °F -240 to +316 °C	-400 to +650 °F -240 to +345 °C	-400 to +750 °F -240 to +399 °C
Discharge Time Constant	≥ 1 sec	≥ 2 sec	—	—	—
Electrical Connector	10-32 Coaxial Jack	10-32 Coaxial Jack	10-32 Coaxial Jack	10-32 Coaxial Jack	10-32 Coaxial Jack
Housing Material	316 Stainless Steel	316 Stainless Steel	17-4 PH Stainless Steel	316 Stainless Steel	316 Stainless Steel
Diaphragm Material	316 Stainless Steel	316 Stainless Steel	316 Stainless Steel	316 Stainless Steel	316 Stainless Steel
Sealing	Welded Hermetic	Welded Hermetic	Welded Hermetic	Welded Hermetic	Welded Hermetic
Supplied Accessories					
English Clamp Nut	—	—	060A03	060A12	060A12
Metric Clamp Nut	—	—	060A05	060A14	060A14
Seal Rings	(3) 065A44	(3) 065A44	(3) 065A02, 065A05	065A37	065A37
Additional Versions					
Metric Mount	M102A10	M102A14	—	—	—
Additional Accessories					
English Installation Tooling Kit	—	—	040A10	—	—
Metric Installation Tooling Kit	—	—	040A11	—	—
Pipe Thread Mounting Adaptor	—	—	062A01	062A06	062A06
English Mounting Adaptor	—	—	061A01	061A60	061A60
Metric Mounting Adaptor	—	—	061A10	—	—
Water-cooled Mounting Adaptor	—	—	064B02	064B06	064B06
Mating Cable Connector	EB	EB	EB	EB	EB
Recommended Cables	002, 003 CE	002, 003 CE	003	003, 029 ≥ 500 °F	003, 029 ≥ 500 °F
Notes					
[1] For +10 volt output, minimum 24 VDC supply voltage required. Negative 10 volt output may be limited by output bias. [2] Zero-based, least-squares, straight line method [3] Resolution dependent on range setting and cable length used in charge system. [4] Special cryogenic microelectronics used in Series 102A sensors are current-sensitive (sensitivity changes about 1% per mA), so they should be used and calibrated w/4mA constant current.					

Hydraulic & Pneumatic Pressure Sensors

Highlights:

- Integral machined diaphragm, without use of thin diaphragms or flexures susceptible to fatigue failure
- Capable of continuously monitoring repetitive pulses
- Expected life is millions of cycles

One of the toughest applications for pressure sensors is measuring high pressure, repetitive pulses, such as those encountered in hydraulic applications. However, our Series 108 & 118 pressure sensors are designed to continuously measure repetitive pulses during applications such as hydraulic cylinder “torture” testing or diesel fuel injection. Ordinary diaphragm-type sensors usually fatigue quickly in such applications.



Hydraulic & Pneumatic Pressure Sensors			
Model Number	108A02	108A04	118A02
Measurement Range	10 kpsi 68,950 kPa	30 kpsi 207,000 kPa	20 kpsi 137,900 kPa
Useful Overrange (± 10 Volt Output) [1]	20 kpsi 137,900 kPa	—	—
Sensitivity	0.5 mV/psi 0.073 mV/kPa	0.15 mV/psi 0.022 mV/kPa	0.1 pC/psi 0.014 pC/kPa
Maximum Static Pressure	50 kpsi 344,740 kPa	50 kpsi 344,750 kPa	50 kpsi 344,750 kPa
Resolution	0.2 psi 1.4 kPa	0.5 psi 3.5 kPa	0.2 psi [3] 1.4 kPa [3]
Resonant Frequency	≥ 250 kHz	≥ 250 kHz	≥ 250 kHz
Rise Time (Reflected)	≤ 2 μsec	≤ 2 μsec	≤ 2 μsec
Low Frequency Response (-5 %)	0.01 Hz	0.002 Hz	—
Non-linearity [2]	≤ 2 %	≤ 2 %	≤ 2 %
Acceleration Sensitivity	≤ 0.05 psi/g ≤ 0.035 psi/(m/s ²)	≤ 0.05 psi/g ≤ 0.035 psi/(m/s ²)	≤ 0.05 psi/g ≤ 0.035 psi/(m/s ²)
Temperature Range	-100 to +275 °F -73 to +135 °C	-100 to +275 °F -73 to +135 °C	-400 to +400 °F -240 to +204 °C
Discharge Time Constant	≥ 50 sec	≥ 250 sec	—
Electrical Connector	10-32 Coaxial Jack	10-32 Coaxial Jack	10-32 Coaxial Jack
Housing Material	C-300	C-300	C-300
Diaphragm Material	C-300	C-300	C-300
Sealing	Welded Hermetic	Welded Hermetic	Epoxy
Supplied Accessory			
Seal Rings	(3) 065A06 316L	(3) 065A06 316L	(3) 065A06 316L
Additional Version			
Metric Mount	M108A02	M108A04	M118A02
Additional Accessories			
Installation Tooling Kits	040A20, 040A21	040A20, 040A21	040A20, 040A21
Mating Cable Connector	EB	EB	EB
Recommended Cables	002, 003 CE	002, 003 CE	003
Notes			
[1] For +10 volt output, minimum 24 VDC supply voltage required. Negative 10 volt output may be limited by output bias. [2] Zero-based, least-squares, straight line method. [3] Resolution dependent on range setting and cable length used in charge system.			

Industrial Dynamic ICP® Pressure Sensors





Highlights

- Welded, hermetically sealed, stainless steel construction
- Electrical case isolation prevents noise interference and ground loop challenges
- Leak proof long life integral machined diaphragm
- Rugged 2-Pin MIL-C-5015 connector or submersible integral cable

Designed specifically for industrial applications, these rugged quartz sensors have a ¼ inch NPT process fitting for ease of installation into standard industrial process connections around the world. (Metric mount available).

Industrial Dynamic ICP® Pressure Sensors

				
Model Number	121A21	121A23	121A31	
Measurement Range (for ±5V output)	100 psi 690 kPa	5 kpsi 34,475 kPa	100 psi 690 kPa	
Maximum Pressure (Step)	200 psi 1380 kPa	—	200 psi 1380 kPa	
Maximum Pressure (Total)	7.2 kpsi 49,642 kPa	7.2 kpsi 49,642 kPa	7.2 kpsi 49,642 kPa	
Sensitivity	50 mV/psi 7.25 mV/kPa	1 mV/psi 0.145 mV/kPa	50 mV/psi 7.25 mV/kPa	
Resolution	4 mpsi 0.0276 kPa	40 mpsi 0.276 kPa	4 mpsi 0.0276 kPa	
Resonant Frequency	≥ 200 kHz	≥ 200 kHz	≥ 200 kHz	
Rise Time (Reflected)	≤ 2.5 μsec	≤ 2.5 μsec	≤ 2.5 μsec	
Low Frequency Response (-5 %)	0.5 Hz	0.005 Hz	0.5 Hz	
Non-linearity [1]	≤ 2 %	≤ 2 %	≤ 2 %	
Acceleration Sensitivity	≤ 0.2 psi/g ≤ 0.14 psi/(m/s ²)	≤ 0.2 psi/g ≤ 0.14 psi/(m/s ²)	≤ 0.2 psi/g ≤ 0.14 psi/(m/s ²)	
Temperature Range	-65 to +250 °F -54 to +121 °C	-65 to +250 °F -54 to +121 °C	-65 to +250 °F -54 to +121 °C	
Discharge Time Constant(at room temp)	≥ 1 sec	≥ 100 sec	≥ 1 sec	
Electrical Connector	2-Pin MIL-C-5015	2-Pin MIL-C-5015	Attached 10 ft (3m) 052 Cable	
Housing Material	304L Stainless	304L Stainless	304L Stainless	
Diaphragm Material	304L Stainless	304L Stainless	304L Stainless	
Sealing	Welded Hermetic	Welded Hermetic	Welded Hermetic	
Additional Versions				
Metric Mount	M121A21	—	M121A31	
Additional Accessories				
Mating Cable Connector	BR	BR	—	
Recommended Cable	052	052	—	
Notes				
[1] Zero-based, least-squares, straight line method				

1500 Series Pressure Transmitters & Transducer

Highlights

- DC to ≤ 1 msec response time
- Stainless steel wetted parts
- All welded construction with no adhesives, seals, or fluid filling
- Gage, sealed gage, absolute, or compound pressure versions



Static Pressure Sensors



Series Number	1501	1502	1503
Output	0 to 5 VDC FS	0 to 10 VDC FS	4-20 mA FS
Supply Voltage (Vs)	6.5 to 30 VDC	11.5 to 30 VDC	8-30 V DC
Pressure Ranges [1]	From 0 to 10 psi (69 kPa) FS up to 0 to 5000 psi (34,473 kPa) FS		
Accuracy [1][2]	$\leq \pm 0.25\%$ FS		
Response Time	≤ 1 ms		
Burst Pressure	$> 35x$ for ≤ 100 psi (≤ 670 kPa) $> 20x$ for ≤ 1000 psi ($\leq 6,890$ kPa) $> 5x$ for ≤ 6000 psi ($\leq 41,370$ kPa)		
Operating Temperature [1]	-40 to +260 °F -40 to +125 °C		
Compensated Temperature Range	-5 to +180 °F -20 to +80 °C		
Thermal Error over Compensated Range	$\leq 1.5\%$ FS		
Acceleration Sensitivity	$\leq \pm 0.03\%$ FS/g		
Vibration Survivability Rating	35 g peak sinusoidal (5 to 2000 Hz)		
Pressure Ports [1]	English, NPT, SI, and "M" Threads		
Materials:			
Wetted parts	17-4 PH SS		
Housing	316/316L SS		
Electrical Connection [1]	Screw Terminals (Mini-DIN), Connector or Integral Cable		

Notes

[1] Consult your PCB Piezotronics representative for specific ordering information and options.
 [2] Accuracy is calculated as the square root of the sum of the squares of non-linearity, non-repeatability and hysteresis.

Request Brochure #TM-PRS-1500-0710 For Details



Series 100A02

Recommended Indicator / Power Supply

4-Digit Indicator with Sensor Power Supply

Provides 24 VDC excitation for voltage output pressure transducers or current output pressure transmitters

High visibility, 4-digit, fully scalable, LED display

Straightforward, menu-driven set-up

Optional user-programmable set points with relays and LED alarm status indicators

Optional 4-20 mA output for process recorder or PLC



High Frequency Pressure Sensors

CE



Series 137

ICP® free-field blast pencil probes
 Ranges from 50 to 5000 psi (344 to 34,475 kPa)
 Rise time <4 µsec
 Resonant frequency >500k Hz

CE



Series 138

ICP® underwater blast explosion pressure probes
 Ranges from 1000 to 50k psi (6894 to 344,740 kPa)
 Rise time <1.5 µsec
 Resonant frequency >1M Hz



Series 132

Shock wave time-of-arrival ICP® microsensors
 50 psi (344 kPa) range
 Rise time <3 µsec
 Resonant frequency >1M Hz
 Diaphragm diameter of 0.124 in (3.15 mm)

CE



Series 134

Designed for reflected shock wave pressure measurement
 Unique non-resonating design, Tourmaline sensing element
 Pressure ranges from 1000 to 20k psi (6894 to 137,900 kPa)
 Rise time ≤ 0.2 µsec

Recommended Signal Conditioners for High Frequency Pressure Sensors

CE



Model 482A21

1-channel
 Unity gain, low-noise, AC powered
 1M Hz response

CE



Series 482C & 483C

AC-powered
 4- & 8-channel versions
 Variety of gain & filtering configurations
 Can operate with charge output sensors
 1M Hz response (482C05 and 483C05 models only)

TEDS
 SECURITY
 COMPATIBLE

CE



Series 481A

AC-powered
 16-channel
 Multiple configuration options
 Can operate with charge output sensors
 Daisy-chain multiple racks for up to 256 channels
 1M Hz response (481A20 model only)

TEDS
 SECURITY
 COMPATIBLE

Installation Tool Kits

Installation tool kits are available to assist in machining mounting ports for applications where PCB® mounting adaptors are not used. The kits provide the tooling necessary for precision machining mounting ports for applicable sensors. Refer to specific installation drawings, listed by model number, found at www.pcb.com, for a detailed description of flush versus recess sensor installation.



Sensor Series	Installation Tool Kit
Series 111, 112, 113	040A10 English, 040A11 Metric
Series 105	040A33 English, 040A34 Metric
Series 108, 109, 118, 119, 165	040A20 English, 040A21 Metric

Mounting Adaptors

What are mounting adaptors?

Mounting adaptors are precision machined to accept PCB probe style pressure sensors to provide a convenient sensor installation method.

Why use mounting adaptors?

When space permits mounting adaptors reduce the need for precision machining required for the probe style connectors in locations where precision machining is impossible, impractical or simply inconvenient, the adapter can be mounted with a few simple steps. The sensor can be electrically isolated in many adaptors to minimize interference from ground loop noise involved with operation on electrical machinery. Special adapter materials, sensor coatings, and insulating seals can be factory installed to isolate the sensor from noise.

Water-cooled adapters provide for sensor installation in high temperature applications for dynamic measurements on heat exchangers or other high temperature applications. Water cooled adapters allow ICP® and charge output pressure sensors to operate in applications with temperatures well above the operating range of the sensor by providing a stable localized lower temp environment. For example, an ICP® sensor, rated to +275°F (+135°C) will remain below +150°F (+65°C) when operating with a Model 064B water-cooled adapter on a +1000°F (+535°C) exhaust manifold.

Most mounting adaptors are made of high-strength 17-4 PH stainless steel. Care should be exercised to observe maximum pressure when using adaptors made of lesser-strength materials.

In sensor applications involving exposure to flash temperatures, an ablative diaphragm coating is beneficial. To captivate the ablative, the sensor may be slightly recessed in an adaptor, and the recess filled with ablative coating such as the PCB® 'CA' option.





A variety of popular adaptors are summarized in the following tables. Many standard and special adaptors can be supplied to fit specific mounting ports, or material requirements so please visit www.pcb.com or contact a PCB® Application Engineer to discuss your unique needs.

FAQ





Q: What is the proper mounting torque?

A: Proper mounting torque is provided on the installation drawing shipped with each sensor.

Pressure Sensor Mounting Adaptors

		Benefits	Limitations
Sensor		Series 111, 112, 113 probe-style sensor, with supplied 5/16-24 or M7x0.75 thread, may be directly mounted using the floating clamp nut. Used when there is limited space available to install a sensor or a flush diaphragm mount is desired.	Requires precision machining tools and dimensions.
	<p>Straight Threads</p>  <p>061A01 3/8-24 or 061A10 M10x1.0 install in common mounting ports. Both made from 17-4 PH stainless steel</p>	<p>Simplified installation by drilling and tapping standard size mounting port. Eliminates precision machining required for probe-style sensors.</p> <p>Adapts Series 111, 112, 113 to thin-walled applications.</p>	Limited to thin-wall or thick, counter bored walls to install. Requires more area to prepare mounting port than a probe-style sensor alone.
Adaptor Type	<p>Electrical Isolation</p>  <p>061A59 3/8-24 thread</p>	Electrically isolates the sensor from ground. Series 111, 112, and 113.	Limits use to lower pressure applications of <500 psi (<3450 kPa), and temperatures $\leq +225$ °F (+107 °C).
	<p>NPT Tapered Threads</p>  <p>062A01 1/8" NPT thread, made from 17-4 PH stainless steel</p>	Thread conveniently adapts Series 111, 112, 113 to common hydraulic, pneumatic, and process mounting ports.	Since the tapered pipe thread seals on the thread itself, it is more difficult to achieve a flush mount of the sensor diaphragm. Requires more area to prepare mounting port than a probe-style sensor alone.
	<p>Water-cooled Adaptors</p>  <p>064B01 recessed mount isolates the sensor from the environment.</p> <p>064B02 flush mount for better high frequency response.</p> <p>Both models feature 1/2-20 mounting thread and are made from 17-4 PH stainless steel.</p>	Adapts Series 111, 112, 113 to high temperature environments.	<p>Requires a larger mounting area.</p> <p>Recessed sensor results in reduced frequency capabilities.</p> <p>Flush sensor means the diaphragm is susceptible to flash thermal effects.</p>

Pressure Sensor Mounting Adaptors

		Benefits	Limitations
Sensor		Models 106B, 116B and 116B03 probe-style sensors, with supplied 1/2-20 or M14x1.25 thread may be directly mounted using the floating clamp nut. Used when there is limited space available to install a sensor or a flush diaphragm mount is desired.	Requires precision machining tools and dimensions.
	<p>Straight Threads</p>  <p>061A60 3/14-16 installs in common mounting ports. Made from 17-4 PH stainless steel</p>	<p>Simplified installation by drilling and tapping standard size mounting port. Eliminates precision machining required for probe-style sensors.</p> <p>Adapts Models 106B, 116B, 116B03 to thin-walled applications.</p>	Limited to thin-wall or thick, counter bored walls to install. Requires more area to prepare mounting port than a probe-style sensor alone.
Adaptor Type	<p>Electrical Isolation</p>  <p>061A61 3/14-16 thread</p>	Electrically isolates the sensor from ground. Series 106 & 116.	Limits use to lower pressure applications of <500 psi (<3450 kPa), and temperatures ≤ +225 °F (+107 °C).
	<p>NPT Tapered Threads</p>  <p>062A06 1/2 in NPT thread, made from 17-4 PH stainless steel</p>	1/2 in NPT thread conveniently adapts Models 106B, 116B and 116B03 to common hydraulic, pneumatic, and process mounting ports. For Models 106B50, 106B51, & 106B52 use adaptor Model 062A07.	Since the tapered pipe thread seals on the thread itself, it is difficult to achieve a flush mount of the sensor diaphragm. Requires more area to prepare mounting port than a probe-style sensor alone.
	<p>Water-cooled Adaptors</p>  <p>064B06 recessed mount isolates the sensor from environment. 1/2-20 thread, made from 17-4 PH stainless steel.</p>	Adapts Models 106B, 116B and 116B03 to high temperature environments.	<p>Requires a larger mounting area.</p> <p>Recessed sensor results in reduced frequency capabilities.</p>

Pressure Calibration Systems

In addition to the products listed below, PCB® is also able to perform a number of special calibration and testing services, upon request. These include acceleration sensitivity; ballistics firing range; cold gas shock tube; discharge time constant; temperature effects from -320 to +1,000 °F (-196 to +535 °C); hydrostatic and hermeticity; mechanical shock; and PIND (Particle Impact Noise Detection).

Dynamic Pressure Sensor Calibration Systems



Pneumatic Pulse Calibrator Model 903B02

Manually actuated poppet valve exposes sensor under test (installed in a small volume manifold) to the step reference pressure, contained & regulated within a much larger storage cavity

- Strain gage pressure sensor reference
- 0 to 100 psi (0 to 0.7 MPa) range
- Accuracy to 0.8% FS



Aronson Step Pressure Calibrator Model 907A07

A guided mass impacts a plate, which quickly opens a poppet valve. This exposes the sensor under test (installed in a small volume manifold) to the step reference pressure, which is contained & regulated within a much larger storage cavity.

- Strain gage pressure sensor reference
- 0 to 1000 psi (0 to 7 MPa) range
- Accuracy to 1.3% FS

Hydraulic Impulse Calibrator Model 913B02

A piston rod on top is struck by a mass to generate a pressure pulse in a two-port manifold for reference comparative calibration

- Piezoelectric pressure sensor reference
- 0 to 20k psi (0 to 138 MPa) range
- Accuracy to 1.3% FS

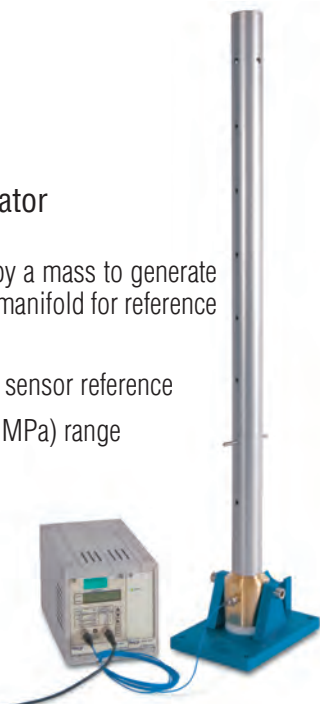

Pistonphone Kit Model 915A01

Generates a constant 134 dB sound pressure level at a controlled frequency of 250 Hz for calibrating high-intensity acoustic sensors in the field. Adaptors included for ICP® Series 103B, 106B, 106B50, and 1-inch microphones.

Special Purpose Calibrators



Hydraulic Step Pressure Calibrator Model 905C

A high-pressure pump exposes the unit under test to graduated pressure steps with dump valve for rapid, pressure release.

Strain gage pressure sensor reference

0 to 100k psi (0 to 690 MPa) range

Accuracy to 1.7% FS



Shock Tube Model 901A10

A gas shock wave is generated past a burst diaphragm to create sub-microsecond pressure steps for evaluating various sensor performance characteristics such as rise time & resonant frequency.

Reflected pressure to 1000 psi (7 MPa)

Incident pressure to 180 psi (1.2 MPa)

Includes time of arrival sensor with 0.5 μ sec rise time

CALIBRATION CERTIFICATE

Model: 112B10	Date: 1/6/2010
Serial #: Sample	By: Joe Calibrator
Description: Pressure Sensor	Station: Dead Weight #5 (Test Procedure AT601-2)
Type: Charge	Capacitance: 26.5 pF
Sensitivity*: 1.143 pC/PSI 165.7 pC/MPa	Temp: 70 deg F [21 deg C]
Linearity*: 0.3% FS	Humidity: 33 %
Uncertainty**: +/- 1 %	Cert #: 346669

* Zero based, least-squares straight line.

** Measurement uncertainty represented using a coverage factor of k=2 which provides a level of confidence of approximately 95 %.

Condition of Unit:

As Found: Not applicable
As Left: In tolerance, new unit

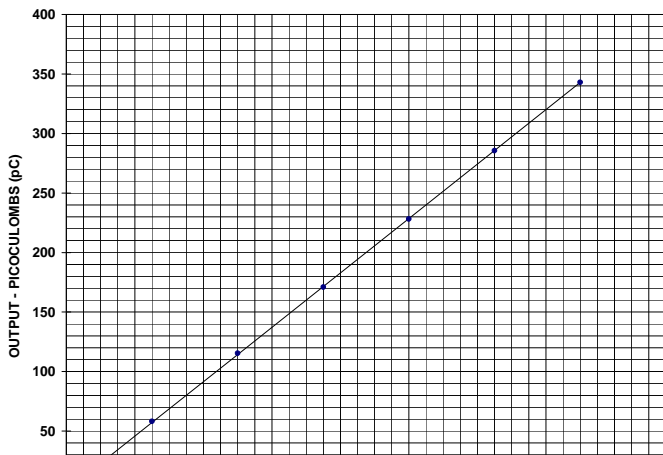

TEST DATA

INPUT (PSI)	OUTPUT (pC)
50.0	58.2
100	115.3
150	171
200	228.2
250	285.5
300	342.9

Sample Pressure Calibration Certificate

Dynamic Force and Strain Sensors

Highlights

- Rugged and durable
- High stiffness
- Very repeatable
- Wide dynamic range
- Fast rise time
- High useable frequency range

Applications

- Crash Testing
- Drop Testing
- Fatigue Testing
- Fracture Testing
- Press Monitoring

Quartz, piezoelectric force and strain sensors are durable measurement devices which possess exceptional characteristics for the measurement of dynamic force and strain events. Typical measurements include dynamic and quasi-static forces as encountered during actuation, compression, impact, impulse, reaction, and tension.

Since the measurement signal generated by a quartz sensor will decay over time, long-term, static force measurements are not feasible. However short-term, or “quasi-static”, measurements are possible within certain time limits, depending upon the sensor and signal conditioning used.

Due to this limitation, it is not practical to use quartz force sensors in weighing applications where strain gage type load cell is best suited. For dynamic force applications however, quartz force sensors offer many advantages and several unique characteristics that make them ideal choice for many dynamic force measurement requirements.

Tips From Techs

Why Piezoelectric Force Sensors?

- Stiffness nearly that of solid steel – 11×10^6 psi modulus of elasticity
- Durability of solid state construction
- Measure small force fluctuations under large static loads
- Long term stability of quartz for repeatable, uniform measurements
- Small size – fraction of the size of strain gage based force sensors
- High frequency response – accurate capture of short-duration impulse events

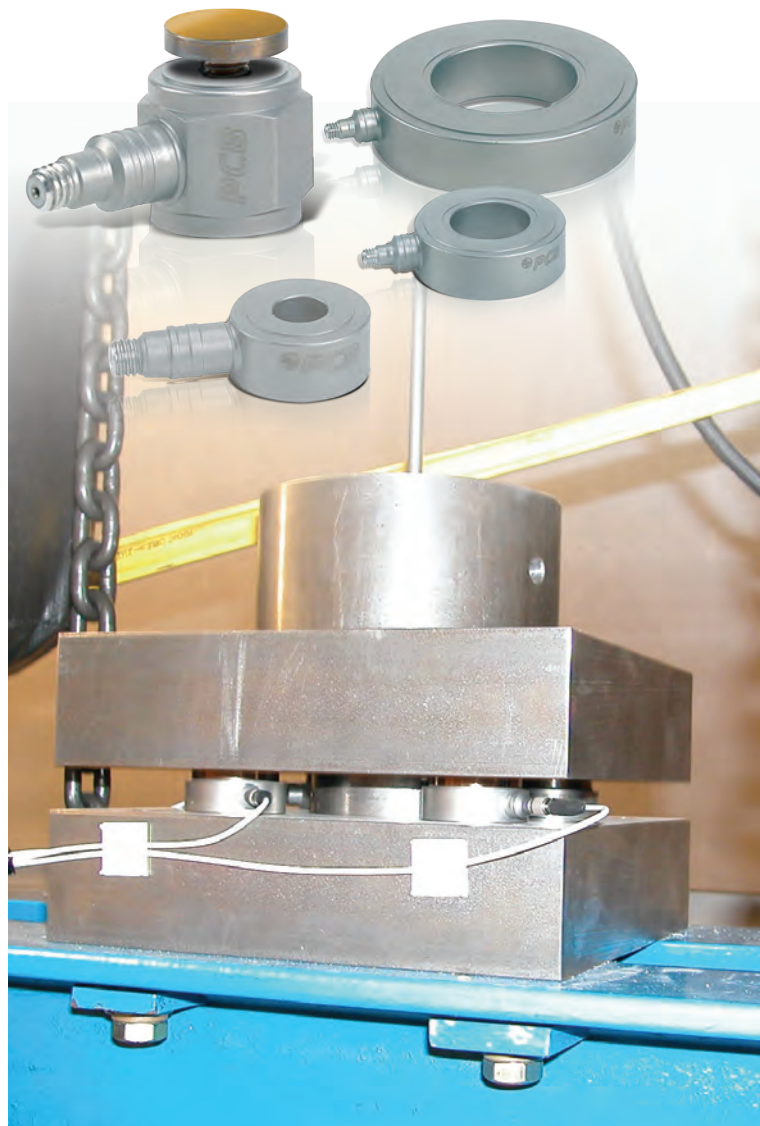

General Purpose Quartz Force Sensors

Applications:

- Dynamic Tension & Compression
- Impact & Repetitive Applications
- Drop Testing
- Materials Testing



General Purpose Quartz Force Sensors



Model Number	208C01	208C02	208C03	208C04	208C05	218C
Measurement Range (Compression)	10 lb 44.5 N	100 lb 445 N	500 lb 2.224 kN	1000 lb 4.448 kN	5000 lb 22.24 kN	5000 lb 22.24 kN
Measurement Range (Tension)	10 lb 44.5 N	100 lb 445 N	500 lb 2.224 kN	500 lb 2.224 kN	500 lb 2.224 kN	500 lb 2.224 kN
Sensitivity	500 mV/lb 112.41 mV/N	50 mV/lb 11.241 mV/N	10 mV/lb 2.248 mV/N	5 mV/lb 1.124 mV/N	1 mV/lb 0.2248 mV/N	18 pC/lb 4.047 pC/N
Maximum Static Force (Compression)	60 lb 270 N	600 lb 2.670 kN	3000 lb 13.5 kN	6000 lb 26.7 kN	8000 lb 35.59 kN	8000 lb 35.59 kN
Maximum Static Force (Tension)	60 lb 270 N	500 lb 2.224 kN	500 lb 2.224 kN	500 lb 2.224 kN	500 lb 2.224 kN	500 lb 2.224 kN
Broadband Resolution	0.0001 lb-rms 0.00045 N-rms	0.001 lb-rms 0.004 N-rms	0.005 lb-rms 0.02 N-rms	0.01 lb-rms 0.044 N-rms	0.05 lb-rms 0.222 N-rms	[1]
Upper Frequency Limit	36 kHz	36 kHz	36 kHz	36 kHz	36 kHz	36 kHz
Low Frequency Response (-5%)	0.01 Hz	0.001 Hz	0.0003 Hz	0.0003 Hz	0.0003 Hz	[2]
Discharge Time Constant	≥ 50 sec	≥ 500 sec	≥ 2000 sec	≥ 2000 sec	≥ 2000 sec	[2]
Non-linearity	≤ 1%	≤ 1%	≤ 1%	≤ 1%	≤ 1%	≤ 1%
Temperature Range	-65 to +250 °F -54 to +121 °C	-65 to +250 °F -54 to +121 °C	-65 to +250 °F -54 to +121 °C	-65 to +250 °F -54 to +121 °C	-65 to +250 °F -54 to +121 °C	-300 to +400 °F -184 to +204 °C
Stiffness	6 lb/μin 1.05 kN/μm	6 lb/μin 1.05 kN/μm	6 lb/μin 1.05 kN/μm	6 lb/μin 1.05 kN/μm	6 lb/μin 1.05 kN/μm	6 lb/μin 1.05 kN/μm
Housing Material	Stainless Steel	Stainless Steel	Stainless Steel	Stainless Steel	Stainless Steel	Stainless Steel
Sealing	Hermetic	Hermetic	Hermetic	Hermetic	Hermetic	Hermetic
Electrical Connector	10-32 Coaxial Jack	10-32 Coaxial Jack	10-32 Coaxial Jack	10-32 Coaxial Jack	10-32 Coaxial Jack	10-32 Coaxial Jack
Size (Hex x Height)	5/8 in x 0.625 in 5/8 in x 15.88 mm	5/8 in x 0.625 in 5/8 in x 15.88 mm	5/8 in x 0.625 in 5/8 in x 15.88 mm	5/8 in x 0.625 in 5/8 in x 15.88 mm	5/8 in x 0.625 in 5/8 in x 15.88 mm	5/8 in x 0.625 in 5/8 in x 15.88 mm
Weight	22.7 gm	22.7 gm	22.7 gm	22.7 gm	22.7 gm	22.7 gm
Mounting Thread	10-32 Thread	10-32 Thread	10-32 Thread	10-32 Thread	10-32 Thread	10-32 Thread

Supplied Accessories

Impact Cap	084A03	084A03	084A03	084A03	084A03	084A03
Mounting Studs	081B05, M081A62	081B05, M081A62	081B05, M081A62	081B05, M081A62	081B05, M081A62	081B05, M081A62
Thread Locker	080A81	080A81	080A81	080A81	080A81	080A81

Additional Version

Axial Connector Configuration	208A11	208A12	208A13	208A14	208A15	218A11
-------------------------------	--------	--------	--------	--------	--------	--------

Additional Accessories

Mating Cable Connectors	EB	EB	EB	EB	EB	EB
Recommended Cables	002, 003 CE	002, 003 CE	002, 003 CE	002, 003 CE	002, 003 CE	003 CE

Notes

[1] Resolution is dependent upon cable length and signal conditioner [2] Low frequency is dependent upon system discharge time constant

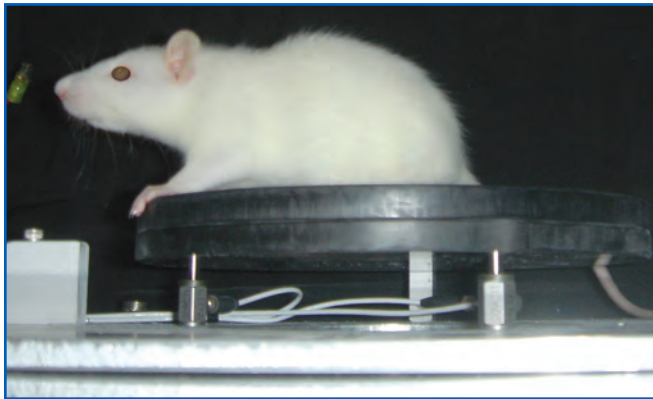





Miniature Quartz Force Sensors

Highlights:

- High sensitivity
- Tension/compression models
- High resonant frequency

Miniature Quartz Force Sensors

					
Model Number	209C01	209C02	209C11	209C12	219A05
Measurement Range (Compression)	2.2 lb 0.00979 kN	2.2 lb 0.00979 kN	2.2 lb 0.00979 kN	2.2 lb 0.00979 kN	560 lb 2.491 kN
Measurement Range (Tension)	—	—	1.0 lb 0.00445	1.0 lb 0.00445	—
Sensitivity	2200 mV/lb 494,604 mV/kN	2200 mV/lb 494,604 mV/kN	2200 mV/lb 494,604 mV/kN	2200 mV/lb 494,604 mV/kN	20 pC/lb 4497 pC/kN
Maximum Static Force (Compression)	11 lb 0.0489 kN	11 lb 0.0489 kN	11 lb 0.0489 kN	11 lb 0.0489 kN	675 lb 3.003 kN
Maximum Static Force (Tension)	—	—	1.0 lb 0.00445 kN	1.0 lb 0.00445 kN	—
Broadband Resolution	0.00002 lb-rms 0.00009 N-rms	0.00002 lb-rms 0.00009 N-rms	0.00002 lb-rms 0.00009 N-rms	0.00002 lb-rms 0.00009 N-rms	[1]
Upper Frequency Limit	100 kHz	100 kHz	30 kHz	30 kHz	140 kHz
Low Frequency Response (-5%)	0.5 Hz	0.05 Hz	0.5 Hz	0.05 Hz	[2]
Discharge Time Constant	≥ 1 sec	≥ 10 sec	≥ 1 sec	≥ 10 sec	[2]
Non-linearity	≤ 1%	≤ 1%	≤ 1%	≤ 1%	≤ 1%
Temperature Range	-65 to +250 °F -54 to +121 °C	-65 to +250 °F -54 to +121 °C	-65 to +250 °F -54 to +121 °C	-65 to +250 °F -54 to +121 °C	-300 to +400 °F -184 to +204 °C
Stiffness	2 lb/μin 0.35 kN/μm	2 lb/μin 0.35 kN/μm	2 lb/μin 0.35 kN/μm	2 lb/μin 0.35 kN/μm	3 lb/μin 1.05 kN/μm
Housing Material	Stainless Steel	Stainless Steel	Stainless Steel	Stainless Steel	Stainless Steel
Sealing	Hermetic	Hermetic	Hermetic	Hermetic	Hermetic
Electrical Connector	10-32 Coaxial Jack	10-32 Coaxial Jack	10-32 Coaxial Jack	10-32 Coaxial Jack	5-44 Coaxial Jack
Size (Hex x Height)	3/8 in x 0.610 in 3/8 in x 15.49 mm	3/8 in x 0.610 in 3/8 in x 15.49 mm	3/8 in x 0.83 in 3/8 in x 21.08 mm	3/8 in x 0.83 in 3/8 in x 21.08 mm	0.236 x 0.236 in [3] 6.0 x 6.0 mm [3]
Weight	8 gm	8 gm	8.2 gm	8.2 gm	1.2 gm
Mounting Thread	10-32 Thread	10-32 Thread	10-32/2-56 Thread	10-32/2-56 Thread	—
Supplied Accessories					
Mounting Stud	081A05	081A05	081A05	081A05	—
Thermal Boot	084A38	084A38	084A38	084A38	—
Additional Version					
Metric Mounting Thread	—	—	M209C11	M209C12	—
Additional Accessories					
Mating Cable Connectors	EB	EB	EB	EB	AG
Recommended Cables	002, 003 CE	002, 003 CE	002, 003 CE	002, 003 CE	003 CE
Notes					
[1] Resolution is dependent upon cable length and signal conditioner [2] Low frequency is dependent upon system discharge time constant [3] Diameter x Height					

Quartz ICP® Force Rings



Preload & Force Rings

PCB® ring-style 1-component and 3-component force sensors are generally installed between two parts of a test structure with the supplied elastic beryllium-copper stud or customer-supplied bolt. The stud or bolt holds the structure together, and applies preload to the force ring. Typically a component of the force between the two structures is shunted through the mounting stud. The amount of force shunted may be up to 7% of the total force for the beryllium-copper stud supplied with the sensor, and up to 50% for steel studs. Contact a PCB® application specialist for proper pre-load and calibration for your particular application.

Applications:

- Crimping, Stamping, & Press Monitoring
- Machinery Mount Forces
- Mechanical Impedance Testing
- Material Testing
- Tablet & Punch Presses
- Roll Nip Profile
- Balancing
- Force Limited Vibration

Quartz ICP® Force Rings

Model Number	201B01	201B02	201B03	201B04	201B05
Measurement Range (Compression)	10 lb 0.04448 kN	100 lb 0.4448 kN	500 lb 2.224 kN	1000 lb 4.448 kN	5000 lb 22.24 kN
Sensitivity	500 mV//lb 112405 mV/kN	50 mV//lb 11240 mV/kN	10 mV//lb 2248 mV/kN	5 mV//lb 1124 mV/kN	1 mV//lb 224.8 mV/kN
Maximum Static Force (Compression)	60 lb 0.267 kN	600 lb 2.67 kN	3000 lb 13.34 kN	6000 lb 26.69 kN	8000 lb 35.59 kN
Broadband Resolution	0.0002 lbs-rms 0.000896 N-rms	0.002 lbs-rms 0.00896 N-rms	0.01 lbs-rms 0.04448 N-rms	0.02 lbs-rms 0.08896 N-rms	0.10 lbs-rms 0.4448 N-rms
Upper Frequency Limit	90 kHz	90 kHz	90 kHz	90 kHz	90 kHz
Low Frequency Response (-5%)	0.01 Hz	0.006 Hz	0.0002 Hz	0.0001 Hz	0.0003 Hz
Discharge Time Constant	≥ 50 sec	≥ 120 sec	≥ 400 sec	≥ 700 sec	≥ 2000 sec
Non-linearity	≤ 1%	≤ 1%	≤ 1%	≤ 1%	≤ 1%
Temperature Range	-65 to +250 °F -54 to +121 °C	-65 to +250 °F -54 to +121 °C	-65 to +250 °F -54 to +121 °C	-65 to +250 °F -54 to +121 °C	-65 to +250 °F -54 to +121 °C
Stiffness	12 lb/μin 2.1 kN/μm	12 lb/μin 2.1 kN/μm	12 lb/μin 2.1 kN/μm	12 lb/μin 2.1 kN/μm	12 lb/μin 2.1 kN/μm
Housing Material	Stainless Steel	Stainless Steel	Stainless Steel	Stainless Steel	Stainless Steel
Sealing	Hermetic	Hermetic	Hermetic	Hermetic	Hermetic
Electrical Connector	10-32 Coaxial Jack	10-32 Coaxial Jack	10-32 Coaxial Jack	10-32 Coaxial Jack	10-32 Coaxial Jack
Size (Diameter x Height x Bolt Diameter)	0.65 x 0.31 x 0.25 in 16.5 x 7.87 x 6 mm	0.65 x 0.31 x 0.25 in 16.5 x 7.87 x 6 mm	0.65 x 0.31 x 0.25 in 16.5 x 7.87 x 6 mm	0.65 x 0.31 x 0.25 in 16.5 x 7.87 x 6 mm	0.65 x 0.31 x 0.25 in 16.5 x 7.87 x 6 mm
Weight	10 gm	10 gm	10 gm	10 gm	10 gm
Mounting	10-32 Stud	10-32 Stud	10-32 Stud	10-32 Stud	10-32 Stud
Supplied Accessories					
Mounting Stud	081A11	081A11	081A11	081A11	081A11
Anti-Friction Washer	082B01	082B01	082B01	082B01	082B01
Pilot Bushing	083B01	083B01	083B01	083B01	083B01
Assembly Lubricant	080A82	080A82	080A82	080A82	080A82
Additional Versions					
Metric Mounting Thread	M201B01	M201B02	M201B03	M201B04	M201B05
Additional Accessories					
Mating Cable Connectors	EB	EB	EB	EB	EB
Recommended Cables	002, 003 CE	002, 003 CE	002, 003 CE	002, 003 CE	002, 003 CE



Photo Shown Actual Size



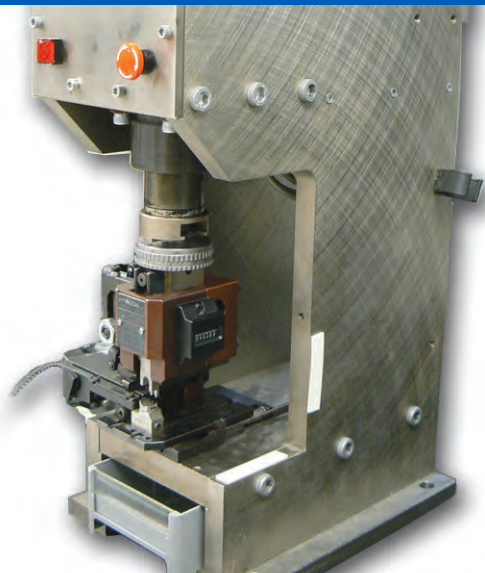



Quartz ICP® Force Rings



Highlights:

- Capacities From 10 lbs to 100k lbs
- Stainless Steel Construction
- Hermetically Sealed
- 65 °F to +250 °F Operation Range

Quartz ICP® Force Rings

						
Model Number	202B	203B	204C	205C	206C	207C
Measurement Range (Compression)	10k lb 44.48 kN	20k lb 88.96 kN	40k lb 177.92 kN	60k lb 266.9 kN	80k lb 355.86 kN	100k lb 444.8 kN
Sensitivity	0.50 mV/lb 112.4 mV/kN	0.25 mV/lb 56.2 mV/kN	0.12 mV/lb 27 mV/kN	0.08 mV/lb 17.98 mV/kN	0.06 mV/lb 13.5 mV/kN	0.05 mV/lb 11.24mV/kN
Maximum Static Force (Compression)	15k lb 66.72 kN	25k lb 111.2 kN	50k lb 222.4 kN	70k lb 311.4 kN	90k lb 400.34 kN	110k lb 489.3 kN
Broadband Resolution	0.20 lb-rms 0.890 N-rms	0.4 lb-rms 1.78 N-rms	0.80 lb-rms 3.6 N-rms	1 lb-rms 4.45 N-rms	1.8 lb-rms 8 N-rms	2.0 lb-rms 8.90 N-rms
Upper Frequency Limit	60 kHz	60 kHz	55 kHz	50 kHz	40 kHz	35 kHz
Low Frequency Response (-5%)	0.0003 Hz	0.0003 Hz	0.0003 Hz	0.0003 Hz	0.0003 Hz	0.0003 Hz
Discharge Time Constant	≥ 2000 sec	≥ 2000 sec	≥ 2000 sec	≥ 2000 sec	≥ 2000 sec	≥ 2000 sec
Non-linearity	≤ 1%	≤ 1%	≤ 1%	≤ 1%	≤ 1%	≤ 1%
Temperature Range	-65 to +250 °F -54 to +121 °C	-65 to +250 °F -54 to +121 °C	-65 to +250 °F -54 to +121 °C	-65 to +250 °F -54 to +121 °C	-65 to +250 °F -54 to +121 °C	-65 to +250 °F -54 to +121 °C
Stiffness	16 lb/μin 2.8 kN/μm	23 lb/μin 4 kN/μm	29 lb/μin 5 kN/μm	40 lb/μin 7 kN/μm	74 lb/μin 13 kN/μm	131 lb/μin 23 kN/μm
Housing Material	Stainless Steel	Stainless Steel	Stainless Steel	Stainless Steel	Stainless Steel	Stainless Steel
Sealing	Hermetic	Hermetic	Hermetic	Hermetic	Hermetic	Hermetic
Electrical Connector	10-32 Coaxial Jack	10-32 Coaxial Jack	10-32 Coaxial Jack	10-32 Coaxial Jack	10-32 Coaxial Jack	10-32 Coaxial Jack
Size (Diameter x Height x Bolt Diameter)	0.87 x 0.39 x 0.375 in 22.1 x 9.91 x 10 mm	1.19 x 0.43 x 0.5 in 27.9 x 10.9 x 12 mm	1.10 x 0.47 x 0.625 in 34 x 12 x 16 mm	1.58 x 0.51 x 0.75 in 40.13 x 12.95 x 20 mm	2.05 x 0.59 x 1 in 52.1 x 15 x 24 mm	2.95 x 0.67 x 1.5 in 74.9 x 17.02 x 36 mm
Weight	19 gm	38 gm	57 gm	77 gm	155 gm	328 gm
Mounting	5/16-24 Stud	3/8-24 Stud	1/2-20 Stud	5/8-18 Stud	7/8-14 Stud	1 1/8-12 Stud
Supplied Accessories						
Mounting Stud	081A12	081A13	081A14	081A15	081A16	081A17
Anti-Friction Washer	082B02	082B03	082B04	082B05	082B06	082B07
Pilot Bushing	083B02	083B03	083B04	083B05	083B06	083B07
Assembly Lubricant	080A82	080A82	080A82	080A82	080A82	080A82
Additional Versions						
Metric Mounting Thread	M202B	M203B	M204C	M205C	M206C	M207C
Additional Accessories						
Mating Cable Connectors	EB	EB	EB	EB	EB	EB
Recommended Cables	002, 003 CE	002, 003 CE	002, 003 CE	002, 003 CE	002, 003 CE	002, 003 CE





Quartz Charge Output Force Rings

Applications

- Material Testing
- Crimping, Stamping, & Press Monitoring
- Roll Nip Profiles
- Machinery Process Monitoring
- Stamping & Forming
- Force Limited Vibration Testing



Quartz Charge Output Force Rings

				
Model Number	211B	212B	213B	214B
Measurement Range (Compression)	5000 lb 22.24 kN	10k lb 44.48 kN	20k lb 88.96 kN	40k lb 177.92 kN
Maximum Static Force (Compression)	8000 lb 35.59 kN	15k lb 66.72 kN	25k lb 111.2 kN	50k lb 222.4 kN
Sensitivity	18 pC/lb 4047 pC/kN	18 pC/lb 4047 pC/kN	18 pC/lb 4047 pC/kN	18 pC/lb 4047 pC/kN
Broadband Resolution	[1]	[1]	[1]	[1]
Upper Frequency Limit	90 kHz	60 kHz	60 kHz	55 kHz
Low Frequency Response (-5%)	[2]	[2]	[2]	[2]
Non-linearity	≤ 1%	≤ 1%	≤ 1%	≤ 1%
Temperature Range	-100 to +400 °F -73 to +204 °C	-100 to +400 °F -73 to +204 °C	-100 to +400 °F -73 to +204 °C	-100 to +400 °F -73 to +204 °C
Electrical Connector	10-32 Coaxial Jack	10-32 Coaxial Jack	10-32 Coaxial Jack	10-32 Coaxial Jack
Stiffness	12 lb/μin 2.1 kN/μm	16 lb/μin 2.8 kN/μm	23 lb/μin 4 kN/μm	29 lb/μin 5 kN/μm
Housing Material	Stainless Steel	Stainless Steel	Stainless Steel	Stainless Steel
Sealing	Hermetic	Hermetic	Hermetic	Hermetic
Size (Diameter x Height x Bolt Diameter)	0.65 x 0.31 x 0.25 in 16.5 x 7.88 x 6 mm	0.87 x 0.39 x 0.375 in 22.1 x 9.91 x 10 mm	1.1 x 0.43 x 0.5 in 27.9 x 10.9 x 12 mm	1.34 x 0.47 x 0.625 in 34 x 11.9 x 16 mm
Weight	10 gm	19 gm	38 gm	57 gm
Mounting	10-32 Stud	5/16-24 Stud	3/8-24 Stud	1/2-20 Stud
Supplied Accessories				
Mounting Stud	081A11	081A12	081A13	081A14
Anti-Friction Washer	082B01	082B02	082B03	082B04
Pilot Bushing	083B01	083B02	083B03	083B04
Assembly Lubricant	080A82	080A82	080A82	080A82
Additional Versions				
Metric Mounting Thread	M211B	M212B	M213B	M214B
Additional Accessories				
Mating Cable Connectors	EB	EB	EB	EB
Recommended Cable	003 CE	003 CE	003 CE	003 CE
Notes				
[1] Resolution is dependent upon cable length and signal conditioner [2] Low frequency is dependent upon system discharge time constant				

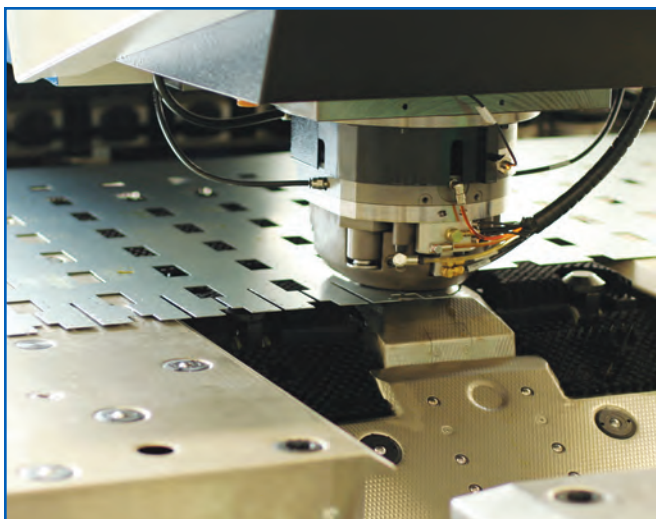



Quartz Charge Output Force Rings

Highlights:

- Wide Temperature Operating Range
(-100 to +400 °F/-73 to 204 °C)
- Scaling & DTC User Settable Via Charge Amplifier
- Hermetically Sealed
- Stainless Steel Construction

Quartz Charge Output Force Rings

			
Model Number	215B	216B	217B
Measurement Range (Compression)	60k lb 266.9 kN	80k lb 355.84 kN	100k lb 444.8 kN
Maximum Static Force (Compression)	70k lb 311.4 kN	90k lb 400.34 kN	110k lb 489.3 kN
Sensitivity	18 pC/lb 4047 pC/kN	18 pC/lb 4047 pC/kN	17 pC/lb 3822 pC/kN
Broadband Resolution	[1]	[1]	[1]
Upper Frequency Limit	50 kHz	40 kHz	35 kHz
Low Frequency Response (-5%)	[2]	[2]	[2]
Non-linearity	≤ 1%	≤ 1%	≤ 1%
Temperature Range	-100 to +400 °F -73 to +204 °C	-100 to +400 °F -73 to +204 °C	-100 to +400 °F -73 to +204 °C
Electrical Connector	10-32 Coaxial Jack	10-32 Coaxial Jack	10-32 Coaxial Jack
Stiffness	40 lb/μin 7 kN/μm	74 lb/μin 13 kN/μm	131 lb/μin 23 kN/μm
Housing Material	Stainless Steel	Stainless Steel	Stainless Steel
Sealing	Hermetic	Hermetic	Hermetic
Size (Diameter x Height x Bolt Diameter)	1.58 x 0.51 x 0.75 in 40.13 x 12.95 x 21 mm	2.05 x 0.59 x 1 in 52.9 x 15 x 26 mm	2.95 x 0.67 x 1.5 in 74.43 x 17.02 x 40 mm
Weight	80 gm	155 gm	354 gm
Mounting	5/8-18 Stud	7/8-14 Stud	1 1/8-12 Stud
Supplied Accessories			
Mounting Stud	081A15	081A16	081A17
Anti-Friction Washer	082B05	082B06	082B07
Pilot Bushing	083B05	083B06	083B07
Assembly Lubricant	080A82	080A82	080A82
Additional Versions			
Metric Mounting Thread	M215B	M216B	M217B
Additional Accessories			
Mating Cable Connectors	EB	EB	EB
Recommended Cables	003 CE	003 CE	003 CE
Notes			
[1] Resolution is dependent upon cable length and signal conditioner [2] Low frequency is dependent upon system discharge time constant			

3-Component Quartz Force Rings and Links 260 & 261 Series



Highlights

- Measure 3-Orthogonal Forces Simultaneously
- Stainless Steel Construction
- Hermetically Sealed
- Choice of ICP® or Charge Versions

Three-component quartz force ring sensors are capable of simultaneously measuring dynamic force in three orthogonal directions (X, Y, and Z). They contain three sets of quartz plates that are stacked in a preloaded arrangement. Each set responds to the vector component of an applied force acting along its sensitive axis. 3-component ring force sensors must be statically pre-loaded for optimum performance. Pre-loading provides the sensing elements with the compressive loading required to allow the proper transmission of shear forces. Versions are available with ranges up to 10k lb (45k N) in the z-axis (perpendicular to the top surface), and up to 4000 lb (18k N) in the x- and y (shear) axes. Both ICP® and charge output styles are available.

Three-component force links eliminate the preload requirement of 3-component quartz force ring sensors, and offers a convenient, 4-screw hole mounting plate on each side end the sensor. Quartz 3-component force links are constructed by installing a 3-component force ring sensor, under pre-load, between two mounting plates.

An elastic, beryllium-copper stud holds this stainless steel assembly together. The use of this elastic stud permits the applied force to be sensed by the crystals with a minimal amount of shunted force. The stud also provides the necessary normal force, and thus friction required to transmit shear forces in the x- and y-axes. Since 3-component force links are factory pre-loaded, they may be used directly for measurements of compression and tension in the z-axis, a positive and negative forces in the x- and y-axes. Versions are available with ranges up to 10k lb (45k N) in the z-axis (perpendicular to the top surface), and up to 4000 lb (18k N) in the x- and y-axes. Both ICP® and charge output styles are available. ICP® designs utilize built-in microelectronic circuitry that provides a low-impedance voltage output via a multipin connector. This arrangement offers system simplicity by requiring only a single multi-conductor sensor cable. The low-impedance voltage signal makes this sensor ideal for use in harsh industrial environments.

Charge output 3-component force sensors operate with in-line charge converters or conventional laboratory-style charge amplifiers. The use of laboratory-style charge amplifiers permits each channel to be independently ranged by the user to maximize signal-to-noise ratio. Charge output styles are recommended for higher temperature applications and can also be used for quasi-static measurements with long discharge time constant charge amplifiers.

3-Component Quartz Force Rings

Applications

Force Limited Vibration Testing

Cutting Tool Forces

Force Dynamometer



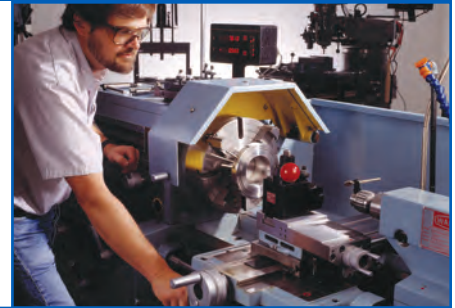

Engine Mount Analysis

Biomechanics

Modal analysis

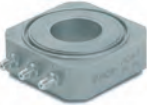

3-Component Quartz Force Rings

						
Model Number	260A01	260A02	260A03	260A11	260A12	260A13
Measurement Range (z axis)	1000 lb 4.45 kN	1000 lb 4.45 kN	10k lb 44.48 kN	1000 lb 4.45 kN	1000 lb 4.45 kN	10k lb 44.48 kN
Measurement Range (x or y axis)	500 lb 2.22 kN	1000 lb 4.45 kN	4000 lb 17.79 kN	500 lb 2.22 kN	1000 lb 4.45 kN	4000 lb 17.7 kN
Sensitivity (z axis)	2.5 mV/lb 0.56 mV/N	2.5 mV/lb 0.56 mV/N	0.25 mV/lb 0.06 mV/N	15 pC/lb 3.37 pC/N	32 pC/lb 7.19 pC/N	15 pC/lb 3.37 pC/N
Sensitivity (x or y axis)	10 mV/lb 2.25 mV/N	5 mV/lb 1.12 mV/N	1.25 mV/lb 0.28 mV/N	32 pC/lb 7.19 pC/N	15 pC/lb 3.37 pC/N	32 pC/lb 7.19 pC/N
Maximum Force (z axis)	1320 lb 5.87 kN	1320 lb 5.87 kN	11 klb 48.93 kN	1320 lb 5.87 kN	1320 lb 5.87 kN	11 klb 48.93 kN
Maximum Force (x or y axis)	660 lb 2.94 kN	1000 lb 4.45 kN	4400 lb 19.57 kN	660 lb 2.94 kN	1000 lb 4.45 kN	4400 lb 19.57 kN
Maximum Moment (z axis)	14 ft-lb 18.98 N-m	40 ft-lb 54.23 N-m	240 ft-lb 325.4 N-m	14 ft-lb 18.98 N-m	40 ft-lb 54.23 N-m	240 ft-lb 325.4 N-m
Maximum Moment (x or y axis)	13 ft-lb 17.63 N-m	70 ft-lb 94.91 N-m	325 ft-lb 440.7 N-m	13 ft-lb 17.63 N-m	70 ft-lb 94.91 N-m	325 ft-lb 440.7 N-m
Broadband Resolution (z axis)	0.006 lb-rms 0.027 N-rms	0.006 lb-rms 0.027 N-rms	0.05 lb-rms 0.222 N-rms	[1]	[1]	[1]
Broadband Resolution (x or y axis)	0.002 lb-rms 0.0089 N-rms	0.006 lb-rms 0.027 N-rms	0.01 lb-rms 0.04 N-rms	[1]	[1]	[1]
Upper Frequency Limit	90 kHz	90 kHz	39 kHz	90 kHz	90 kHz	39 kHz
Low Frequency Response (-5%) (z axis)	0.01 Hz	0.01 Hz	0.01 Hz	[2]	[2]	[2]
Low Frequency Response (-5%) (x or y axis)	0.001 Hz	0.001 Hz	0.001 Hz	[2]	[2]	[2]
Discharge Time Constant (z axis)	≥ 50 sec	≥ 50 sec	≥ 50 sec	—	—	—
Discharge Time Constant (x or y axis)	≥ 500 sec	≥ 500 sec	≥ 500 sec	—	—	—
Non-Linearity	≤ 1% FS	≤ 1% FS	≤ 1% FS	≤ 1% FS	≤ 1% FS	≤ 1% FS
Temperature Range	-65 to +250 °F -54 to +121 °C	-65 to +250 °F -54 to +121 °C	-65 to +250 °F -54 to +121 °C	-100 to +350 °F -73 to +177 °C	-100 to +350 °F -73 to +177 °C	-100 to +350 °F -73 to +177 °C
Stiffness (z axis)	10 lb/μin 1.75 kN/μm	19 lb/μin 3.3 kN/μm	40 lb/μin 7 kN/μm	10 lb/μin 1.75 kN/μm	19 lb/μin 3.3 kN/μm	40 lb/μin 7 kN/μm
Stiffness (x or y axis)	4 lb/μin 0.7 kN/μm	6 lb/μin 1 kN/μm	15 lb/μin 2.6 kN/μm	4 lb/μin 0.7 kN/μm	6 lb/μin 1 kN/μm	15 lb/μin 2.6 kN/μm
Housing Material	Stainless Steel	Stainless Steel	Stainless Steel	Stainless Steel	Stainless Steel	Stainless Steel
Sealing	Hermetic	Hermetic	Hermetic	Hermetic	Hermetic	Hermetic
Electrical Connector(s)	1/4-28 4-Pin Jack	1/4-28 4-Pin Jack	1/4-28 4-Pin Jack	10-32 Coaxial Jacks	10-32 Coaxial Jacks	10-32 Coaxial Jacks
Size (Length x Width x Height)	1.075 x 0.95 x 0.39 27.3 x 24.1 x 9.9	1.35 x 1.25 x 0.39 34.3 x 31.8 x 9.9	2.25 x 2.25 x 0.79 57.1 x 57.1 x 20.07	0.95 x 0.95 x 0.39 24.1 x 24.1 x 9.9	1.25 x 1.25 x 0.39 31.8 x 31.8 x 9.9	2.25 x 2.25 x 0.79 57.1 x 57.1 x 20.07
Weight	26 gm	45 gm	271 gm	25 gm	43 gm	280 gm
Supplied Accessories						
Mounting Stud	081A70	081A74	081A71	081A70	081A74	081A71
Anti-Friction Washer	082B02	082M12	082B06	082B02	082M12	082B06
Pilot Bushing	083A10	083A13	083A11	083A10	083A13	083A11
Additional Versions						
Metric Mounting Thread	M260A01	M260A02	M260A03	M260A11	M260A12	M260A13
Additional Accessories						
Mating Cable Connector	AY	AY	AY	EB	EB	EB
Recommended Cable	010	010	010	003 CE	003 CE	003 CE
Notes						
[1] Resolution is dependent upon cable length and signal conditioner [2] Low frequency is dependent upon system discharge time constant						

3-Component Quartz Force Links



Highlights

Easy flange mounting
 Fixed preloaded assembly
 Measures 3 orthogonal (Fx, Fy, Fz)

Applications

ICP® & charge models
 English & metric models
 Impact Testing
 Biomechanics
 Force Plates
 Force-limited Vibration
 Vehicle Dynamics
 Cutting Tool Force Monitoring

3-Component Quartz Force Links

						
Model Number	261A01	261A02	261A03	261A11	261A12	261A13
Measurement Range (z axis)	1000 lb 4.45 kN	1000 lb 4.45 kN	10k lb 44.48 kN	1000 lb 4.45 kN	1000 lb 4.45 kN	10k lb 44.48 kN
Measurement Range (x or y axis)	500 lb 2.22 kN	1000 lb 4.45 kN	4000 lb 17.79 kN	500 lb 4.45 kN	1000 lb 4.45 kN	4000 lb 17.7 kN
Sensitivity (z axis)	2.5 mV/lb 0.56 mV/N	2.5 mV/lb 0.56 mV/N	0.25 mV/lb 0.06 mV/N	15 pC/lb 3.37 pC/N	32 pC/lb 7.19 pC/N	15 pC/lb 3.37 pC/N
Sensitivity (x or y axis)	10 mV/lb 2.25 mV/N	5 mV/lb 1.12 mV/N	1.25 mV/lb 0.28 mV/N	32 pC/lb 7.19 pC/N	15 pC/lb 3.37 pC/N	32 pC/lb 7.19 pC/N
Maximum Force (z axis)	1320 lb 5.87 kN	1320 lb 5.87 kN	11k lb 48.93 kN	1320 lb 5.87 kN	1320 lb 5.87 kN	11k lb 48.93 kN
Maximum Force (x or y axis)	660 lb 2.94 kN	1000 lb 4.45 kN	4400 lb 19.57 kN	660 lb 2.94 kN	1000 lb 4.45 kN	4400 lb 19.57 kN
Maximum Moment (z axis)	14 ft-lb 18.98 N-m	40 ft-lb 54.23 N-m	240 ft-lb 325.4 N-m	14 ft-lb 18.98 N-m	40 ft-lb 54.23 N-m	240 ft-lb 325.4 N-m
Maximum Moment (x or y axis)	13 ft-lb 17.63 N-m	70 ft-lb 94.91 N-m	325 ft-lb 440.7 N-m	13 ft-lb 17.63 N-m	70 ft-lb 94.91 N-m	325 ft-lb 440.7 N-m
Broadband Resolution (z axis)	0.006 lb-rms 0.027 N-rms	0.006 lb-rms 0.027 N-rms	0.05 lb-rms 0.222 N-rms	[1]	[1]	[1]
Broadband Resolution (x or y axis)	0.002 lb-rms 0.0089 N-rms	0.006 lb-rms 0.027 N-rms	0.01 lb-rms 0.04 N-rms	[1]	[1]	[1]
Upper Frequency Limit	10 kHz	10 kHz	10 kHz	10 kHz	10 kHz	10 kHz
Low Frequency Response (-5%) (z axis)	0.01 Hz	0.01 Hz	0.01 Hz	[2]	[2]	[2]
Low Frequency Response (-5%) (x or y axis)	0.001 Hz	0.001 Hz	0.001 Hz	[2]	[2]	[2]
Discharge Time Constant (z axis)	≥ 50 sec	≥ 50 sec	≥ 50 sec	N/A	N/A	N/A
Discharge Time Constant (x or y axis)	≥ 500 sec	≥ 500 sec	≥ 500 sec	N/A	N/A	N/A
Non-Linearity	≤ 1% FS	≤ 1% FS	≤ 1% FS	≤ 1% FS	≤ 1% FS	≤ 1% FS
Temperature Range	-65 to +250 °F -54 to +121 °C	-65 to +250 °F -54 to +121 °C	-65 to +250 °F -54 to +121 °C	-100 to +350 °F -73 to +177 °C	-100 to +350 °F -73 to +177 °C	-100 to +350 °F -73 to +177 °C
Stiffness (z axis)	10 lb/μin 1.75 kN/μm	19 lb/μin 3.3 kN/μm	40 lb/μin 7 kN/μm	10 lb/μin 1.75 kN/μm	19 lb/μin 3.3 kN/μm	40 lb/μin 7 kN/μm
Stiffness (x or y axis)	4 lb/μin 0.7 kN/μm	6 lb/μin 1 kN/μm	15 lb/μin 2.6 kN/μm	4 lb/μin 0.7 kN/μm	6 lb/μin 1 kN/μm	15 lb/μin 2.6 kN/μm
Housing Material	Stainless Steel	Stainless Steel	Stainless Steel	Stainless Steel	Stainless Steel	Stainless Steel
Sealing	Hermetic	Hermetic	Hermetic	Hermetic	Hermetic	Hermetic
Electrical Connector(s)	1/4-28 4-Pin Jack	1/4-28 4-Pin Jack	1/4-28 4-Pin Jack	10-32 Coaxial Jacks	10-32 Coaxial Jacks	10-32 Coaxial Jacks
Size (Length x Width x Height)	1.65 x 1.65 x 1.65 in 42 x 42 x 42 mm	2.16 x 2.16 x 2.35 in 55 x 55 x 60 mm	3.15 x 3.15 x 3.54 in 80 x 80 x 90 mm	1.65 x 1.65 x 1.65 in 42 x 42 x 42 mm	2.16 x 2.16 x 2.35 in 55 x 55 x 59.60 mm	3.15 x 3.15 x 3.54 in 80 x 80 x 90 mm
Weight	386 gm	975 gm	2994 gm	386 gm	975 gm	2994 gm
Mounting	1/4-28 Thread	5/16-24 Thread	3/8-24 Thread	1/4-28 Thread	5/16-24 Thread	3/8-24 Thread
Additional Versions						
Metric Mounting Threads	M261A01	M261A02	M261A03	M261A11	M261A12	M261A13
Additional Accessories						
Mating Cable Connectors	AY	AY	AY	EB	EB	EB
Recommended Cables	010	010	010	003 CE	003 CE	003 CE
Notes	[1] Resolution is dependent upon cable length and signal conditioner [2] Low frequency is dependent upon system discharge time constant					



Quartz ICP® Force Links

Polarity of Quartz Force Sensors

The output voltage polarity of ICP® force sensors is positive for compression and negative for tension force measurements. The polarity of PCB® charge output force sensors is the opposite: negative for compression and positive for tension. This is because charge output sensors are used with external charge amplifiers that exhibit an inverting characteristic. Therefore, the resulting system output polarity of the charge amplifier system is positive for compression and negative for tension; same as for an ICP® sensor system (reverse polarity sensors are also available).

Applications:

- Tensile Testing
- Press Monitoring
- Material Testing
- Machine Process Monitoring

Quartz ICP® Force Links



Model Number	221B01	221B02	221B03	221B04	221B05
Measurement Range (Compression)	10 lb 0.04448 kN	100 lb 0.4448 kN	500 lb 2.224 kN	1000 lb 4.448 kN	5000 lb 22.24 kN
Measurement Range (Tension)	10 lb 0.04448 kN	100 lb 0.4448 kN	500 lb 2.224 kN	1000 lb 4.448 kN	1000 lb 4.448 kN
Maximum Static Force (Compression)	60 lb 0.2669 kN	600 lb 2.669 kN	3000 lb 13.34 kN	6000 lb 26.69 kN	6000 lb 26.69 kN
Maximum Static Force (Tension)	60 lb 0.2669 kN	500 lb 2.224 kN	1,000 lb 4.448 kN	1200 lb 5.34 kN	1200 lb 5.34 kN
Sensitivity	500 mV/lb 112404 mV/kN	50 mV/lb 11241 mV/kN	10 mV/lb 2248.2 mV/kN	5 mV/lb 1124.1 mV/kN	1 mV/lb 224.82 mV/kN
Broadband Resolution	0.0002 lb-rms 0.0008896 N-rms	0.002 lb-rms 0.008896 N-rms	0.01 lb-rms 0.04448 N-rms	0.02 lb-rms 0.08896 N-rms	0.1 lb-rms 0.445 N-rms
Upper Frequency Limit	15 kHz	15 kHz	15 kHz	15 kHz	15 kHz
Low Frequency Response (-5%)	0.01 Hz	0.006 Hz	0.002 Hz	0.001 Hz	0.003 Hz
Discharge Time Constant	≥ 50 sec	≥ 120 sec	≥ 400 sec	≥ 700 sec	≥ 2000 sec
Non-linearity	≤ 1%	≤ 1%	≤ 1%	≤ 1%	≤ 1%
Temperature Range	-65 to +250 °F -54 to +121 °C	-65 to +250 °F -54 to +121 °C	-65 to +250 °F -54 to +121 °C	-65 to +250 °F -54 to +121 °C	-65 to +250 °F -54 to +121 °C
Electrical Connector	10-32 Coaxial Jack	10-32 Coaxial Jack	10-32 Coaxial Jack	10-32 Coaxial Jack	10-32 Coaxial Jack
Stiffness	2 lb/μin 0.35 kN/μm	2 lb/μin 0.35 kN/μm	2 lb/μin 0.35 kN/μm	2 lb/μin 0.35 kN/μm	2 lb/μin 0.35 kN/μm
Housing Material	Stainless Steel	Stainless Steel	Stainless Steel	Stainless Steel	Stainless Steel
Sealing	Hermetic	Hermetic	Hermetic	Hermetic	Hermetic
Size (Diameter x Height)	0.65 x 1.25 in 16.5 x 31.75 mm	0.65 x 1.25 in 16.5 x 31.75 mm	0.65 x 1.25 in 16.5 x 31.75 mm	0.65 x 1.25 in 16.5 x 31.75 mm	0.65 x 1.25 in 16.5 x 31.75 mm
Weight	31 gm	31 gm	31 gm	31 gm	31 gm
Mounting	1/4-28 Thread	1/4-28 Thread	1/4-28 Thread	1/4-28 Thread	1/4-28 Thread
Additional Versions					
Charge Output	—	—	—	—	231B
Metric Mounting Threads	M221B01	M221B02	M221B03	M221B04	M221B05
Additional Accessories					
Mating Cable Connectors	EB	EB	EB	EB	EB
Recommended Cables	002, 003 CE	002, 003 CE	002, 003 CE	002, 003 CE	002, 003 CE

Quartz ICP® Force Links



Piezoelectric System Output







The output characteristic of piezoelectric sensors is that of an AC coupled system, where repetitive signals will decay until there is an equal area above and below the original base line. As magnitude levels of the monitored event fluctuate, the output will remain stabilized around the base line with the positive and negative areas of the curve remaining equal.



Applications:

- Tension & Compression
- Push Rod Testing
- Machinery Process Monitoring
- Repetitive Operations
- Press Force Monitoring
- Tensile Testing

Quartz ICP® Force Links

						
Model Number	222B	223B	224C	225C	226C	227C
Measurement Range (Compression)	6000 lb 26.69 kN	12k lb 53.38 kN	25k lb 111.2 kN	35k lb 155.69 kN	45k lb 200.16 kN	50k lb 222.40 kN
Measurement Range (Tension)	2500 lb 11.12 kN	4000 lb 17.79 kN	8000 lb 35.58 kN	12k lb 53.38 kN	20k lb 88.96 kN	30k lb 133.44 kN
Sensitivity	0.90 mV/lb 202.34 mV/kN	0.42 mV/lb 94.42 mV/kN	0.20 mV/lb 44.96 mV/kN	0.14 mV/lb 31.47 mV/kN	0.11 mV/lb 24.73 mV/kN	0.10 mV/lb 22.48 mV/kN
Maximum Static Force (Compression)	6500 lb 31.14 kN	10k lb 44.48 kN	29k lb 137.89 kN	43k lb 189.05 kN	55k lb 244.65 kN	66k lb 293.57 kN
Maximum Static Force (Tension)	2800 lb 12.45 kN	4500 lb 20.02 kN	10k lb 44.48 kN	15k lb 66.73 kN	25k lb 111.21 kN	37.5k lb 166.8 kN
Broadband Resolution	0.2 lb-rms 0.8896 N-rms	0.4 lb-rms 1.779 N-rms	0.6 lb-rms 2.67 N-rms	0.1 lb-rms 0.445 N-rms	0.44 lb-rms 1.96 N-rms	1 lb-rms 4.45 N-rms
Upper Frequency Limit	12 kHz	10 kHz	8 kHz	6 kHz	5 kHz	4 kHz
Low Frequency Response (-5%)	0.0003 Hz	0.0003 Hz	0.0003 Hz	0.0003 Hz	0.0003 Hz	0.0003 Hz
Discharge Time Constant	≥ 2000 sec	≥ 2000 sec	≥ 2000 sec	≥ 2000 sec	≥ 2000 sec	≥ 2000 sec
Non-Linearity	≤ 1% FS	≤ 1% FS	≤ 1.5% FS	≤ 1.5% FS	≤ 1% FS	≤ 1% FS
Temperature Range	-65 to +250 °F -54 to +121 °C	-65 to +250 °F -54 to +121 °C	-65 to +250 °F -54 to +121 °C	-65 to +250 °F -54 to +121 °C	-65 to +250 °F -54 to +121 °C	-65 to +250 °F -54 to +121 °C
Stiffness	3 lb/μin 0.53 kN/μm	4 lb/μin 0.7 kN/μm	6 lb/μin 1.05 kN/μm	6 lb/μin 1.05 kN/μm	11 lb/μin 1.9 kN/μm	29 lb/μin 5 kN/μm
Housing Material	Stainless Steel	Stainless Steel	Stainless Steel	Stainless Steel	Stainless Steel	Stainless Steel
Sealing	Hermetic	Hermetic	Hermetic	Hermetic	Hermetic	Hermetic
Electrical Connector	10-32 Coaxial Jack	10-32 Coaxial Jack	10-32 Coaxial Jack	10-32 Coaxial Jack	10-32 Coaxial Jack	10-32 Coaxial Jack
Size (Diameter x Height)	0.87 in x 1.62 in 22.1 mm x 41.5 mm	1.1 in x 2.0 in 27.94 mm x 50.8 mm	1.34 in x 2.5 in 34.04 mm x 63.5 mm	1.58 in x 3.0 in 40.13 mm x 76.2 mm	2.05 in x 3.5 in 52.07 mm x 88.9 mm	2.95 in x 4.25 in 74.93 mm x 108 mm
Weight	58 gm	120 gm	246 gm	412 gm	907 gm	2353 gm
Mounting Thread	3/8-24 Thread	1/2-20 Thread	5/8-18 Thread	3/4-16 Thread	1-12 Thread	1 1/4-12 Thread
Additional Versions						
Charge Output	232B	233B	234B	235B	236B	237B
Metric Mounting Thread	M222B	M223B	M224C	M225C	M226C	M227C
Additional Accessories						
Mating Cable Connector	EB	EB	EB	EB	EB	EB
Recommended Cables	002, 003 CE	002, 003 CE	002, 003 CE	002, 003 CE	002, 003 CE	002, 003 CE

Quartz ICP® Impact Force Sensors



Applications

- Impact Testing
- Stamping Presses
- Crash Testing
- Package Drop
- Punch & Tablet Presses

Quartz ICP® Impact Force Sensors

CE



Model Number	200B01	200B02	200B03	200B04
Measurement Range (Compression)	10 lb 0.04448 kN	100 lb 0.4448 kN	500 lb 2.224 kN	1000 lb 4.448 kN
Sensitivity	500 mV/lb 112,410 mV/kN	50 mV/lb 11,241 mV/kN	10 mV/lb 2248 mV/kN	5 mV/lb 1124 mV/kN
Maximum Static Force (Compression)	150 lb 0.6672 kN	600 lb 2.67 kN	3000 lb 13.34 kN	5000 lb 22.24 kN
Broadband Resolution	0.0002 lbs-rms 0.0008896 N-rms	0.002 lbs-rms 0.008896 N-rms	0.01 lbs-rms 0.04445 N-rms	0.02 lbs-rms 0.08890 N-rms
Upper Frequency Limit	75 kHz	75 kHz	75 kHz	75 kHz
Low Frequency Response (-5%)	0.01 Hz	0.001 Hz	0.0003 Hz	0.0003 Hz
Discharge Time Constant	≥ 50 sec	≥ 500 sec	≥ 2000 sec	≥ 2000 sec
Non-linearity	≤ 1%	≤ 1%	≤ 1%	≤ 1%
Temperature Range	-65 to +250 °F -54 to +121 °C	-65 to +250 °F -54 to +121 °C	-65 to +250 °F -54 to +121 °C	-65 to +250 °F -54 to +121 °C
Stiffness	11 lb/μin 1.9 kN/μm	11 lb/μin 1.9 kN/μm	11 lb/μin 1.9 kN/μm	11 lb/μin 1.9 kN/μm
Housing Material	Stainless Steel	Stainless Steel	Stainless Steel	Stainless Steel
Sealing	Hermetic	Hermetic	Hermetic	Hermetic
Electrical Connector	10-32 Coaxial Jack	10-32 Coaxial Jack	10-32 Coaxial Jack	10-32 Coaxial Jack
Size (Diameter x Height)	0.65 x 0.36 in 16.51 x 9.14 mm	0.65 x 0.36 in 16.51 x 9.14 mm	0.65 x 0.36 in 16.51 x 9.14 mm	0.65 x 0.36 in 16.51 x 9.14 mm
Weight	14 gm	14 gm	14 gm	14 gm
Mounting	10-32 Thread	10-32 Thread	10-32 Thread	10-32 Thread
Supplied Accessories				
Adhesive Impact Pad	084A83	084A83	084A83	084A83
Mounting Stud	081B05, M081A62	081B05, M081A62	081B05, M081A62	081B05, M081A62
Thread Locker	080A81	080A81	080A81	080A81
Additional Accessories				
Mating Cable Connectors	EB	EB	EB	EB
Recommended Cables	002, 003 CE	002, 003 CE	002, 003 CE	002, 003 CE

Quartz ICP® Impact Force Sensors

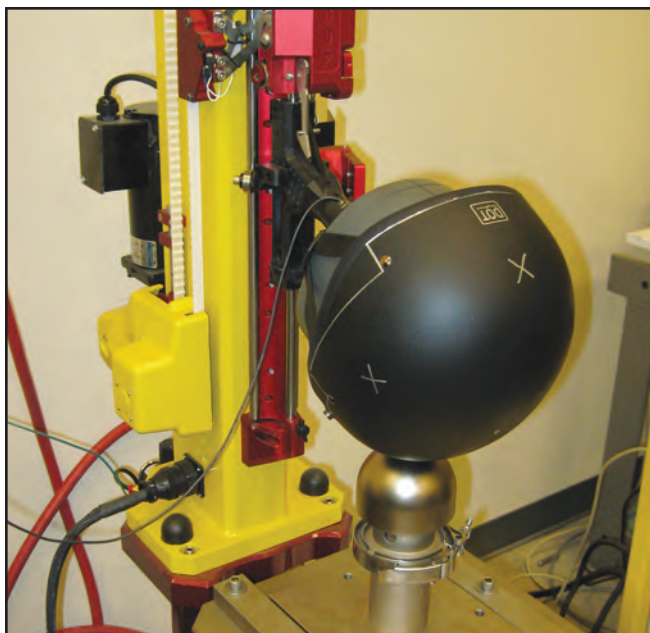

Applications:

- Package Drop Testing
- Shock Testing
- Repetitive Impacts
- Crash Testing
- Punch & Tablet Presses



Helmet Impact Attenuation Testing – Courtesy of ATS, Inc. (www.atslab.com)

Quartz ICP® Impact Force Sensors

	CE 	CE 	CE 
Model Number	200B05	200C20	200C50
Measurement Range (Compression)	5000 lb 22.24 kN	20k lb 88.96 kN	50k lb 222.4 kN
Sensitivity	1 mV/lb 224.8 mV/kN	0.25 mV/lb 56.2 mV/kN	0.10 mV/lb 22.48 mV/kN
Maximum Static Force (Compression)	8000 lb 35.59 kN	30k lb 133.44 kN	75k lb 333.6 kN
Broadband Resolution	0.10 lbs-rms 0.4448 N-rms	0.3 lb-rms 1.3 N-rms	1 lb-rms 4.45 N-rms
Upper Frequency Limit	75 kHz	40 kHz	30 kHz
Low Frequency Response (-5%)	0.0003 Hz	0.0003 Hz	0.0003 Hz
Discharge Time Constant	≥ 2000 sec	≥ 2000 sec	≥ 2000 sec
Non-linearity	≤ 1%	≤ 1%	≤ 1%
Temperature Range	-65 to +250 °F -54 to +121 °C	-65 to +250 °F -54 to +121 °C	-65 to +250 °F -54 to +121 °C
Stiffness	11 lb/μin 1.9 kN/μm	63 lb/μin 11 kN/μm	97 lb/μin 17 kN/μm
Housing Material	Stainless Steel	Stainless Steel	Stainless Steel
Sealing	Hermetic	Hermetic	Hermetic
Electrical Connector	10-32 Coaxial Jack	10-32 Coaxial Jack	10-32 Coaxial Jack
Size (Diameter x Height)	0.65 x 0.36 in 16.51 x 9.14 mm	1.5 x 0.5 in 38.1 x 12.7 mm	2.125 x 0.75 in 53.9 x 19.0 mm
Weight	14 gm	88 gm	280 gm
Mounting	10-32 Thread	1/4-28 Thread	1/4-28 Thread
Supplied Accessories			
Impact Cap	081B05	084B23	084A36
Mounting Stud	081B05, M081A62	081A06, 081B20, M081A61	081A06, 081B20, M081A61
Thread Locker	080A81	080A81	080A81
Additional Accessories			
Mating Cable Connectors	EB	EB	EB
Recommended Cables	002, 003 CE	002, 003 CE	002, 003 CE

ICP® Strain Sensors For Process Monitoring/Quality Control

Highlights

- Measure longitudinal strain on machinery structures
- Control press forces and other processes
- Monitor quality, safety, and reliability
- Robust construction endures harsh, industrial environments
- Simple installation is noninvasive to process

The Series M240 Industrial ICP® Strain Sensors incorporate piezoelectric quartz sensing crystals that respond to a longitudinal change in distance. The resultant strain measurand is an indirect measurement of stress forces acting along the structure to which the sensor is mounted. As such, these devices can provide insight into the behavior of mechanical systems or processes that generate an associated machinery reaction.

Monitoring such measurement signals can provide the necessary indication for process interrupt and pass/fail decisions or for determining wear and degradation of equipment and tooling. The sensors are used for controlling processes in plastic injection molding, spot welding, stamping, and pressing, as well as monitoring processes and final product quality. These devices are easy to install and can be powered by any ICP® sensor signal conditioner such as our DIN rail module 410B01.

In addition to providing ICP® power, the 410B01 serves as an interface between sensor and machine control. Features such as independent peak and continuous outputs, gain, and selection of AC/DC coupling make integration straight forward.



Dynamic Strain Sensors

Highlights



- Measures longitudinal strain on machinery structures
- Simple installation
- Robust construction for harsh, industrial environments
- Single bolt or adhesive mount screw

Applications

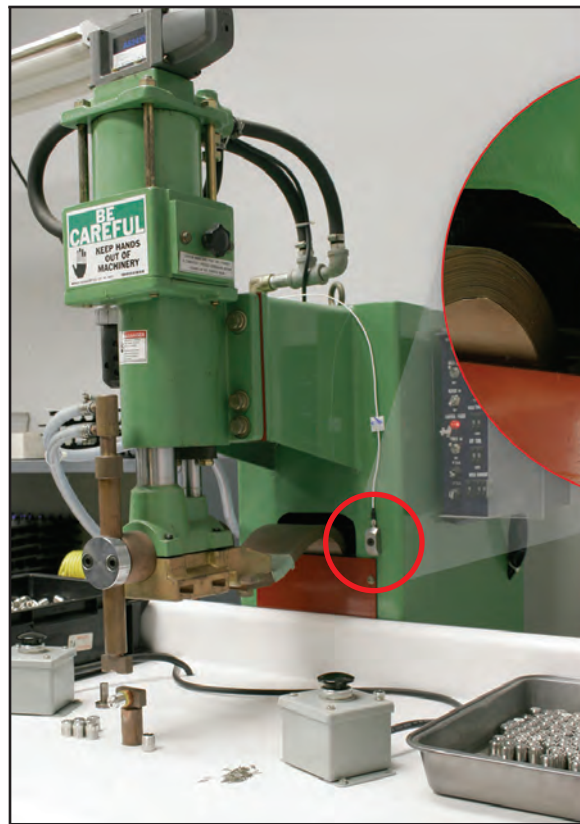
- Process monitoring
- Control press forces & other processes
- Monitor quality, safety, & reliability
- Composite material Testing



Dynamic Strain Sensors

				
Model Number	RHM240A01	RHM240A02	RHM240A03	740B02
Measurement Range (Compression)	50 p μ	100 p μ	300 p μ	100 p μ
Sensitivity	100 mV/ μ	50 mV/ μ	10 mV/ μ	50 mV/ μ
Broadband Resolution	0.0001 μ	0.0002 μ	0.001 μ	0.0006 μ
Low Frequency Response (-5%)	0.015 Hz	0.004 Hz	0.004 Hz	0.5 Hz
Discharge Time Constant	\geq 35 sec	\geq 150 sec	\geq 150 sec	1 to 3 sec
Non-linearity	\leq 2%	\leq 2%	\leq 2%	\leq 1%
Temperature Range	-65 to +250 °F -54 to +121 °C	-65 to +250 °F -54 to +121 °C	-65 to +250 °F -54 to +121 °C	-65 to +250 °F -54 to +121 °C
Housing Material	Stainless Steel	Stainless Steel	Stainless Steel	Titanium
Sealing	Epoxy	Epoxy	Epoxy	Epoxy
Electrical Connector	10-32 Coaxial Jack	10-32 Coaxial Jack	10-32 Coaxial Jack	Integral Cable
Size (Length x Width x Height)	1.81 x 0.67 x 0.6 in 46 x 17 x 15.2 mm	1.81 x 0.67 x 0.6 in 46 x 17 x 15.2 mm	1.81 x 0.67 x 0.6 in 46 x 17 x 15.2 mm	0.2 x 0.64 x 0.7 in 5.1 x 15.2 x 1.8 mm 0.5 gm
Weight	45 gm	45 gm	45 gm	0.5 gm
Mounting	Through Hole	Through Hole	Through Hole	Adhesive
Supplied Accessory				
Mounting Screw	M081A100	M081A100	M081A100	None
Additional Accessories				
Mating Cable Connectors	EB	EB	EB	—
Recommended Cables	002, 003 CE	002, 003 CE	002, 003 CE	—

Force & Strain Sensor Mounting Accessories



081B05
Mounting Stud



084A03
Impact Cap



081A05
Mounting Stud



081A08
Mounting Stud

Mounting Studs and Screws			
Model Number	Threads	Length In (cm)	Comment
Short Studs			
081A05	10-32 to 10-32	0.27 (0.69)	Series 209
M081A05	10-32 to M6 x 0.75	0.27 (0.69)	Series M209
081B05	10-32 to 10-32	0.27 (0.69)	with shoulder for Series 208 and Models 200B01-B05, 210B
M081B05	10-32 to M6 x 0.75	0.27 (0.69)	adaptor stud with shoulder for Models M200B01-B05, M210B
081A08	10-32 to 1/4-28	0.30 (0.76)	adaptor stud
081A06	10-32 to 1/4-28	0.37 (0.94)	no shoulder
081B20	10-32 to 1/4-28	0.37 (0.94)	with shoulder for Models 200C20 & C50, 210B20 & B50
M081B21	10-32 to M6 x 0.75	0.37 (0.94)	adaptor stud for Models M200C20 & C50, M210B20 & B50
M081A62	10-32 to M6 x 1.0	0.325 (0.83)	Series 208
Long Studs			
081A11	10-32 to 10-32	0.73 (1.85)	for Models 201B01-B05, 201A75-A76
M081A11	M5 x 0.8 to M5 x 0.8	0.73 (1.85)	for Models M201B01-B05, M201A75-A76
081A12	5/16-24 to 5/16-24	0.91 (2.31)	for Models 202B, 212B
M081A12	M8 x 1.0 to M8 x 1.0	0.91 (2.31)	for Models M202B, M212B
081A13	3/8-24 to 3/8-24	1.10 (2.79)	for Models 203B, 213B
M081A13	M10 x 1.0 to M10 x 1.0	1.10 (2.79)	for Models M203B, M213B
081A14	1/2-20 to 1/2-20	1.40 (3.56)	for Models 204B, 214B
M081A14	M14 x 1.25 to M14 x 1.25	1.40 (3.56)	for Models M204B, M214B
081A15	5/8-18 to 5/8-18	1.65 (4.19)	for Models 205B, 215B
M081A15	M16 x 1.5 to M16 x 1.5	1.65 (4.19)	for Models M205B, M215B
081A16	7/8-14 to 7/8-14	1.90 (4.83)	for Models 206B, 216B
M081A16	M22 x 2.0 to M22 x 2.0	1.90 (4.83)	for Models M206B, M216B
081A17	1 1/8-12 to 1 1/8-12	2.28 (5.79)	for Models 207B, 217B
M081A17	M30 x 2.0 to M30 x 2.0	2.28 (5.79)	for Models M207B, M217B
081A70	5/16-24 to 5/16-24	1.42 (3.61)	pre-load bolt for Models 260A01, 260A11
M081A70	M8 x 1.25 to M8 x 1.25	1.42 (3.61)	pre-load bolt for Models M260A01, M260A11
081A71	7/8-14 to 7/8-14	2.40 (6.1)	pre-load bolt for Models 260A03, 260A13
M081A71	M24 x 3 to M24 x 3	2.40 (6.1)	pre-load bolt for Models M260A03, M260A13
081A74	1/2-20 to 1/2-20	1.11 (2.82)	pre-load bolt for Models 260A02, 260A12
M081A74	M12 x 1.25 to M12 x 1.25	1.11 (2.82)	pre-load bolt for Models M260A02, M260A12
Screws			
081A25	10-32	0.50 (1.27)	capscrew
M081A25	M5 x 0.8	0.50 (1.27)	capscrew
081A26	10-32	0.75 (1.91)	capscrew
M081A26	M5 x 0.8	0.75 (1.91)	capscrew

Custom studs are available. Contact factory for details.

Anti-Friction Washers and Pilot Bushings		
Washer	Bushing	Usage
082B01	083B01	Models 201B01-B05, 211B
082B01	M083B01	Models M201B01-B05, M211B
N/A	083A15	Models 201A75, 201A76
N/A	M083A15	Models M201A75, M201A76
082B02	083B02	Models 202B, 212B
082B02	M083B02	Models M202B, M212B
082B03	083B03	Models 203B, 213B
082B03	M083B03	Models M203B, M213B
082B04	083B04	Models 204B, 214B
082B04	M083B04	Models M204B, M214B
082B05	083B05	Models 205B, 215B
082B05	M083B05	Models M205B, M215B
082B06	083B06	Models 206B, 216B
082B06	M083B06	Models M206B, M216B
082B07	083B07	Models 207B, 217B
082B07	M083B07	Models M207B, M217B
082B02	083A10	Models 260A01, 260A11, M260A01, M260A11
082B06	083A11	Models 260A03, 260A13, M260A03, M260A13
082M12	083A13	Models 260A02, 260A12, M260A02, M260A12
Impact Plates		
Model	Usage	Comment
084A01	Series 208	Flat
084A03	Series 208	Convex
084A19	Model 208A33	Penetration
084A35	Model 208A35	Penetration
084A36	Models 200C50, 210B50	Convex
084A45	Model 208A45	Penetration
084B23	Models 200C20, 210C20	Convex
084M02	Series 208	Flat, hardened for matrix print head applications



PCB Load & Torque, Inc., a wholly-owned subsidiary of PCB Piezotronics, is a manufacturer of high quality, precision load cells, torque transducers, and telemetry units. In addition to the quality products produced, the PCB Load & Torque facility offers many services including: A2LA Accredited Calibration for torque, force, and related instrumentation; an A2LA Accredited Threaded Fastener Testing Laboratory; and complete and reliable custom stain gaging. PCB Load & Torque products and services fulfill the test and measurement needs of numerous industries including: Aerospace & Defense, Automotive, Medical Rehabilitation, Material Testing, Textile, Process Control, Robotics & Automation, and more.

RS Technologies, a division of PCB Load & Torque Inc., designs and manufactures fastener technology test systems and threaded fastener torque/angle/tension systems. Products and services are ideal for use in the Automotive, Aerospace & Defense, Power Generation, and various other test and measurement applications, including manufacturers or processors of threaded fasteners, or companies that use threaded fasteners to assemble their products.

The expert team of Design, Engineering, Sales, and Customer Service individuals draw upon vast in-house manufacturing resources to continually provide new, more beneficial sensing solutions. From ready-to-ship stock products, to custom-made specials, PCB Load & Torque, and the RS Technologies division, proudly stand behind all products with services customers value most, including a 24-hour customer support, a global distribution network, Total Customer Satisfaction. For more information please visit www.pcbloadtorque.com.

24350 Indoplex Circle, Farmington Hills, MI 48335 USA

Toll-Free in USA 866-684-7107

24-hour SensorLineSM 716-684-0001

Fax 716-684-0987 **E-mail** ltinfo@pcbloadtorque.com

www.pcbloadtorque.com

ISO 9001:2015 QMS CERTIFIED BY DQS, INC. A2LA ACCREDITED to ISO 17025

General Purpose & Fatigue Rated Load Cells

Highlights:

- Low deflection, high accuracy
- Low profile
- Temperature & pressure compensated
- A2LA accreditation calibration
- NIST traceable calibration

PCB® load cells address many force measurement, monitoring, and control requirements in laboratory testing, industrial, and process control applications. All models utilize strain gages, which are configured into a Wheatstone Bridge circuit as their primary sensing element, along with temperature and pressure compensation. A variety of configurations and capacities address a wide range of installation scenarios. General purpose load cells are suitable for a wide range of routine static force measurement applications including: weighing, dynamometer testing, and material testing machines. Most of these designs operate in both tension and compression, and offer excellent accuracy and value. Units range in capacity from as small as 25 lbf, to as large as 50k lbf (110 N to 220 kN) full scale.

Fatigue-rated load cells are specifically designed for fatigue testing machine manufacturers and users, or any application where high cyclic loads are present. Applications include material testing, component life cycle testing, and structural testing. All fatigue-rated load cells are guaranteed against fatigue failure for 100 million fully reversed cycles. These rugged load cells are manufactured using premium, fatigue-resistant, heat-treated steels. Internal flexures are carefully designed to eliminate stress concentration areas. Close attention is paid to the proper selection and installation of internal strain gages and wiring to ensure maximum life. Fatigue-rated load cells are available in capacities from 250k lbf to 100k lbf (1100 N to 450 kN) full-scale.

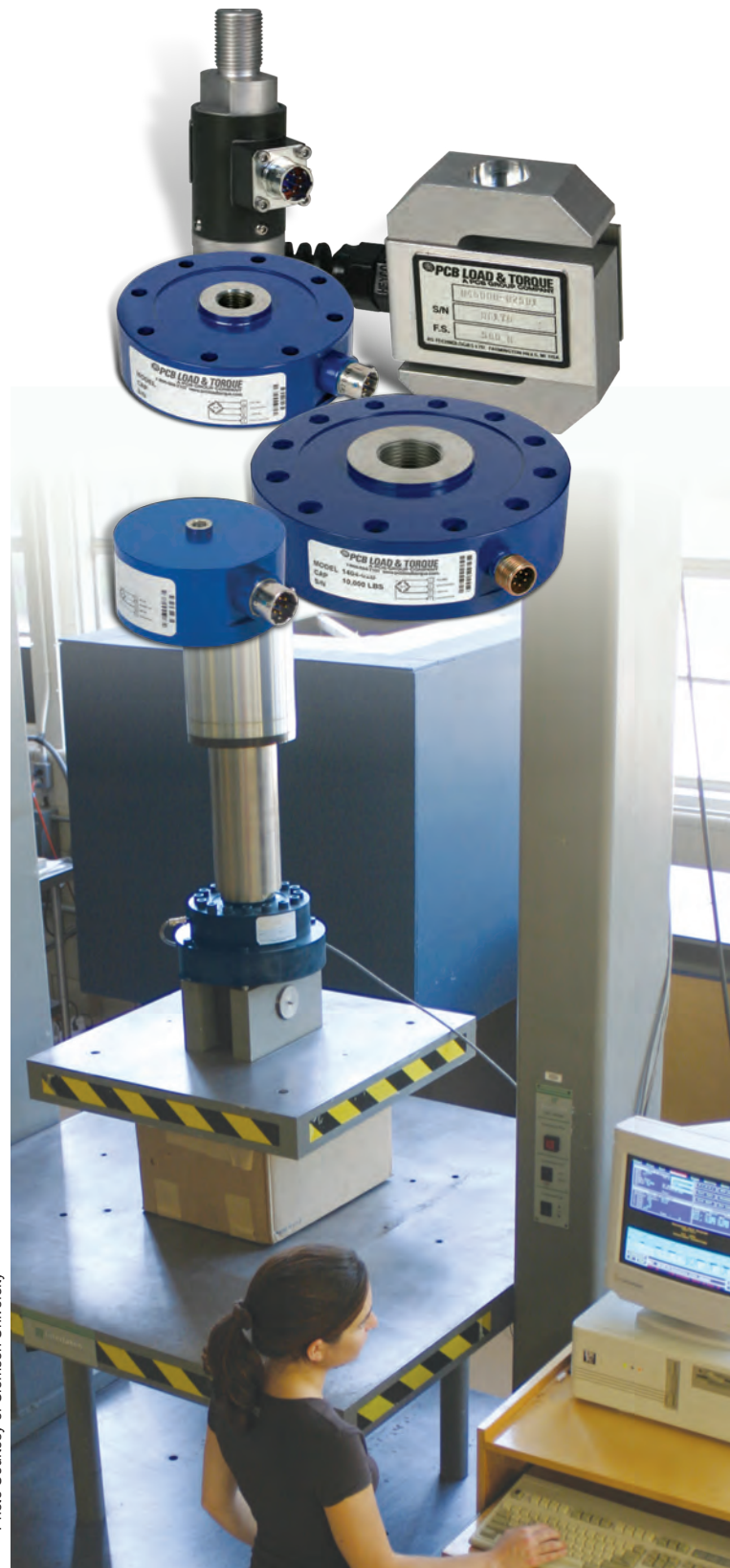



Photo Courtesy of Clemson University

General Purpose Canister Style Load Cells



General Purpose

General purpose load cells are designed for a multitude of applications across the Test & Measurement, Automotive, Aerospace and Industrial markets. The general purpose load cell, as the name implies, is designed to be utilitarian in nature. Within the general purpose load cell market there are several distinct categories: precision, universal, weigh scale, and special application. PCB Load & Torque, Inc. primarily supplies general purpose load cells into the universal and special application categories. Universal load cells are the most common in industry.

General Purpose Canister Style Load Cells					
					
Model Number	1102-05A	1102-01A	1102-02A	1102-03A	1102-04A
Measurement Range	25 lbf 111 N	50 lbf 222 N	100 lbf 445 N	200 lbf 900 N	300 lbf 1334 N
Overload Limit	38 lbf 167 N	75 lbf 333 N	150 lbf 667 N	300 lbf 1334 N	450 lbf 2000 N
Sensitivity	2 mV/V	2 mV/V	2 mV/V	2 mV/V	2 mV/V
Non-Linearity	≤ 0.1% FS	≤ 0.05% FS	≤ 0.05% FS	≤ 0.05% FS	≤ 0.05% FS
Hysteresis	≤ 0.1% FS	≤ 0.05% FS	≤ 0.05% FS	≤ 0.05% FS	≤ 0.05% FS
Non-Repeatability	≤ 0.05% FS	≤ 0.02% FS	≤ 0.02% FS	≤ 0.02% FS	≤ 0.02% FS
Temperature Range	-65 to +200 °F -54 to +93 °C	-65 to +200 °F -54 to +93 °C	-65 to +200 °F -54 to +93 °C	-65 to +200 °F -54 to +93 °C	-65 to +200 °F -54 to +93 °C
Temperature Range Compensated	+70 to +170 °F +21 to +76 °C	+70 to +170 °F +21 to +76 °C	+70 to +170 °F +21 to +76 °C	+70 to +170 °F +21 to +76 °C	+70 to +170 °F +21 to +76 °C
Bridge Resistance	700 Ohm	700 Ohm	700 Ohm	700 Ohm	700 Ohm
Excitation Voltage [1]	10 VDC	10 VDC	10 VDC	10 VDC	10 VDC
Size (Diameter x Height)	2.75 x 1.5 in 69.9 x 38.1 mm	2.75 x 1.5 in 69.9 x 38.1 mm	2.75 x 1.5 in 69.9 x 38.1 mm	2.75 x 1.5 in 69.9 x 38.1 mm	2.75 x 1.5 in 69.9 x 38.1 mm
Mounting	1/4-28 Thread	1/4-28 Thread	1/4-28 Thread	1/4-28 Thread	1/4-28 Thread
Electrical Connector	PT02E-10-6P	PT02E-10-6P	PT02E-10-6P	PT02E-10-6P	PT02E-10-6P
Supplied Accessory					
Shunt Calibration Resistor	Yes	Yes	Yes	Yes	Yes
Additional Version					
Alternate Attachment Thread	M1102-05A M6 x 1-6H	M1102-01A M6 x 1-6H	M1102-02A M6 x 1-6H	M1102-03A M6 x 1-6H	M1102-04A M6 x 1-6H
Additional Accessories					
Mating Electrical Connector	181-012A (PT)	181-012A (PT)	181-012A (PT)	181-012A (PT)	181-012A (PT)
Recommended Cable	8311-01-10A (PT)	8311-01-10A (PT)	8311-01-10A (PT)	8311-01-10A (PT)	8311-01-10A (PT)
Note					
[1] Calibrated at 10 VDC, useable 5 to 20 VDC or VAC RMS					

General Purpose Low Profile Load Cells

Highlights

- Low profile design
- Low deflection
- NIST traceable calibration
- Built-in temperature compensation
- Direct replacement for competitive models

Applications

- Weighing
- Dynamometer
- Static Material Test Machines

General Purpose Low Profile Load Cells



Model Number	1203-01A	1203-02A	1203-03A	1203-04A	1203-05A	1204-02A	1204-03A
Measurement Range	500 lbf 2.2 kN	1k lbf 4.4 kN	2k lbf 8.9 kN	5k lbf 22.2 kN	10k lbf 44.5 kN	20k lbf 89 kN	50k lbf [2] 222 kN
Overload Limit	750 lbf 3.3 kN	1.5k lbf 6.6 kN	3k lbf 13.3 kN	7.5k lbf 33.3 kN	15k lbf 66.7 kN	37.5k lbf 166 kN	75k lbf 334 kN
Sensitivity	2 mV/V	2 mV/V	2 mV/V	3 mV/V	3 mV/V	3 mV/V	3 mV/V
Non-Linearity	≤ 0.05% FS	≤ 0.05% FS	≤ 0.05% FS	≤ 0.05% FS	≤ 0.05% FS	≤ 0.05% FS	≤ 0.05% FS
Hysteresis	≤ 0.05% FS	≤ 0.05% FS	≤ 0.05% FS	≤ 0.05% FS	≤ 0.05% FS	≤ 0.05% FS	≤ 0.05% FS
Non-Repeatability	≤ 0.02% FS	≤ 0.02% FS	≤ 0.02% FS	≤ 0.02% FS	≤ 0.02% FS	≤ 0.02% FS	≤ 0.02% FS
Temperature Range	-65 to +200 °F -54 to +93 °C	-65 to +200 °F -54 to +93 °C	-65 to +200 °F -54 to +93 °C	-65 to +200 °F -54 to +93 °C	-65 to +200 °F -54 to +93 °C	-65 to +200 °F -54 to +93 °C	-65 to +200 °F -54 to +93 °C
Temperature Range Compensated	+70 to +170 °F +21 to +76 °C	+70 to +170 °F +21 to +76 °C	+70 to +170 °F +21 to +76 °C	+70 to +170 °F +21 to +76 °C	+70 to +170 °F +21 to +76 °C	+70 to +170 °F +21 to +76 °C	+70 to +170 °F +21 to +76 °C
Bridge Resistance	700 Ohm	700 Ohm	700 Ohm	700 Ohm	700 Ohm	700 Ohm	700 Ohm
Excitation Voltage [1]	10 VDC	10 VDC	10 VDC	10 VDC	10 VDC	10 VDC	10 VDC
Size (Diameter x Height)	4.12 x 1.37 in 104.6 x 34.8 mm	4.12 x 1.37 in 104.6 x 34.8 mm	4.12 x 1.37 in 104.6 x 34.8 mm	4.12 x 1.37 in 104.6 x 34.8 mm	4.12 x 1.37 in 104.6 x 34.8 mm	6.06 x 1.75 in 153.9 x 44.5 mm	6.06 x 1.75 in 153.9 x 44.5 mm
Mounting	5/8-18 Thread	5/8-18 Thread	5/8-18 Thread	5/8-18 Thread	5/8-18 Thread	1 1/4 -12 Thread	1 1/4 -12 Thread
Electrical Connector	PT02E-10-6P	PT02E-10-6P	PT02E-10-6P	PT02E-10-6P	PT02E-10-6P	PT02E-10-6P	PT02E-10-6P
Supplied Accessories							
Shunt Calibration Resistor	Yes	Yes	Yes	Yes	Yes	Yes	Yes
Additional Versions							
Alternate Electrical Connector	1203-01B PC04E-10-6P	1203-02B PC04E-10-6P	1203-03B PC04E-10-6P	1203-04B PC04E-10-6P	1203-05B PC04E-10-6P	1204-02B PC04E-10-6P	1204-03B PC04E-10-6P
Alternate Attachment Thread	M1203-01A M1203-01B M16 x 2-4H	M1203-02A M1203-02B M16 x 2-4H	M1203-03A M1203-03B M16 x 2-4H	M1203-04A M1203-04B M16 x 2-4H	M1203-05A M1203-05B M16 x 2-4H	M1204-02A M1204-02B M33 x 2-4H	M1204-03A M1204-03B M33 x 2-4H
Additional Accessories							
Mounting Bases	084A100 M084A100	084A100 M084A100	084A100 M084A100	084A100 M084A100	084A100 M084A100	084A101 M084A101	084A101 M084A101
Mating Electrical Connectors	181-012A (PT) 182-025A (PC)	181-012A (PT) 182-025A (PC)	181-012A (PT) 182-025A (PC)	181-012A (PT) 182-025A (PC)	181-012A (PT) 182-025A (PC)	181-012A (PT) 182-025A (PC)	181-012A (PT) 182-025A (PC)
Recommended Cables	8311-01-10A (PT) 8315-01-10A (PC)	8311-01-10A (PT) 8315-01-10A (PC)	8311-01-10A (PT) 8315-01-10A (PC)	8311-01-10A (PT) 8315-01-10A (PC)	8311-01-10A (PT) 8315-01-10A (PC)	8311-01-10A (PT) 8315-01-10A (PC)	8315-01-10A (PC) 8311-01-10A (PT)
Note							
[1] Calibrated at 10 VDC, useable 5 to 20 VDC or VAC RMS [2] Requires optional mounting base (084A101)							

Fatigue-Rated Low Profile Load Cells

Highlights

- Low profile design
- Low deflection
- High accuracy
- NIST traceable calibration
- Barometric pressure compensated construction
- Built-in temperature compensation
- Direct replacement for competitive models

Fatigue-Rated Load Cells are specifically designed for fatigue testing machine manufacturers and users, or in any application where high cyclic loads are present. Applications include material testing, component life cycle testing, and structural testing. All Fatigue Rated Load Cells are guaranteed against fatigue failure for 100 million fully reversed cycles. As an added benefit, these load cells are extremely resistant to extraneous bending and side loading forces.

Fatigue-Rated Low Profile Load Cells







Model Number	1403-01A	1403-02A	1403-03A	1403-04A	1403-05A
Measurement Range	250 lbf 1.1 kN	500 lbf 2.2 kN	1k lbf 4.5 kN	2.5k lbf 11.1 kN	5k lbf 22.2 kN
Overload Limit	500 lbf 2.2 kN	1k lbf 4.4 kN	2k lbf 8.9 kN	5k lbf 22.2 kN	10k lbf 44.5 kN
Sensitivity	1 mV/V	1 mV/V	1 mV/V	1.5 mV/V	1.5 mV/V
Non-Linearity	≤ 0.05% FS	≤ 0.05% FS	≤ 0.05% FS	≤ 0.05% FS	≤ 0.05% FS
Hysteresis	≤ 0.05% FS	≤ 0.05% FS	≤ 0.05% FS	≤ 0.05% FS	≤ 0.05% FS
Non-Repeatability	≤ 0.02% FS	≤ 0.02% FS	≤ 0.02% FS	≤ 0.02% FS	≤ 0.02% FS
Temperature Range	-65 to +200 °F -54 to +93 °C	-65 to +200 °F -54 to +93 °C	-65 to +200 °F -54 to +93 °C	-65 to +200 °F -54 to +93 °C	-65 to +200 °F -54 to +93 °C
Temperature Range Compensated	+70 to +170 °F +21 to +76 °C	+70 to +170 °F +21 to +76 °C	+70 to +170 °F +21 to +76 °C	+70 to +170 °F +21 to +76 °C	+70 to +170 °F +21 to +76 °C
Bridge Resistance	700 Ohm	700 Ohm	700 Ohm	700 Ohm	700 Ohm
Excitation Voltage [1]	10 VDC	10 VDC	10 VDC	10 VDC	10 VDC
Size (Diameter x Height)	4.12 x 1.37 in 104.6 x 34.8 mm	4.12 x 1.37 in 104.6 x 34.8 mm	4.12 x 1.37 in 104.6 x 34.8 mm	4.12 x 1.37 in 104.6 x 34.8 mm	4.12 x 1.37 in 104.6 x 34.8 mm
Mounting	5/8-18 Thread	5/8-18 Thread	5/8-18 Thread	5/8-18 Thread	5/8-18 Thread
Electrical Connector	PT02E-10-6P	PT02E-10-6P	PT02E-10-6P	PT02E-10-6P	PT02E-10-6P
Supplied Accessory					
Shunt Calibration Resistor	Yes	Yes	Yes	Yes	Yes
Additional Versions					
Alternate Electrical Connector	1403-01B PC04E-10-6P	1403-02B PC04E-10-6P	1403-03B PC04E-10-6P	1403-04B PC04E-10-6P	1403-05B PC04E-10-6P
Alternate Attachment Threads	M1403-01A M1403-01B M16 x 2-4H	M1403-02A M1403-02B M16 x 2-4H	M1403-03A M1403-03B M16 x 2-4H	M1403-04A M1403-04B M16 x 2-4H	M1403-05A M1403-05B M16 x 2-4H
Available Accessories					
Mounting Bases	084A100 M084A100	084A100 M084A100	084A100 M084A100	084A100 M084A100	084A100 M084A100
Mating Electrical Connectors	181-012A (PT) 182-025A (PC)	181-012A (PT) 182-025A (PC)	181-012A (PT) 182-025A (PC)	181-012A (PT) 182-025A (PC)	181-012A (PT) 182-025A (PC)
Recommended Cables	8311-01-10A (PT) 8315-01-10A (PC)	8311-01-10A (PT) 8315-01-10A (PC)	8311-01-10A (PT) 8315-01-10A (PC)	8311-01-10A (PT) 8315-01-10A (PC)	8311-01-10A (PT) 8315-01-10A (PC)
Note					
[1] Calibrated at 10 VDC, useable 5 to 20 VDC or VAC RMS					

Tips From Techs

General Purpose and Fatigue Rated Low Profile Load Cells are designed to be loaded through the provided top center thread for both tension and compression loads. The outside diameter of this type of load cells must be mounted to a flat, rigid surface by means of the provided bolt pattern. When a proper surface is not available, optional mounting bases are available for all models. When ordered at the same time as the load cell, the mounting base is factory installed with grade 8 bolts tightened to 60% of yield. This provides a convenient tapped thread hole of the same diameter and pitch as the load cell itself. For most applications, it is recommended that the load cell be ordered with the optional mounting base for ease of installation.

Fatigue-Rated Low Profile Load Cells

Fatigue-Rated Low Profile Load Cells

				
Model Number	1404-02A	1404-03A	1408-02A	1411-02A
Measurement Range	10k lbf 44.5 kN	25k lbf 111.2 kN	50k lbf 222 kN	100k lbf 450 kN
Overload Limit	20k lbf 89 kN	50k lbf 222.4 kN	100k lbf 445 kN	200k lbf 900 kN
Sensitivity	1.5 mV/V	1.75 mV/V	1.5 mV/V	1.5 mV/V
Non-Linearity	≤ 0.05% FS	≤ 0.05% FS	≤ 0.1% FS	≤ 0.2% FS
Hysteresis	≤ 0.05% FS	≤ 0.05% FS	≤ 0.1% FS	≤ 0.2% FS
Non-Repeatability	≤ 0.02% FS	≤ 0.02% FS	≤ 0.05% FS	≤ 0.05% FS
Temperature Range	-65 to +200 °F -54 to +93 °C	-65 to +200 °F -54 to +93 °C	-65 to +200 °F -54 to +93 °C	-65 to +200 °F -54 to +93 °C
Temperature Range Compensated	+70 to +170 °F +21 to +76 °C	+70 to +170 °F +21 to +76 °C	+70 to +170 °F +21 to +76 °C	+70 to +170 °F +21 to +76 °C
Bridge Resistance	700 Ohm	700 Ohm	700 Ohm	700 Ohm
Excitation Voltage [1]	10 VDC	10 VDC	10 VDC	10 VDC
Size (Diameter x Height)	6.06 x 1.75 in 153.9 x 44.5 mm	6.06 x 1.75 in 153.9 x 44.5 mm	8.00 x 2.50 in 203 x 63.5 mm	11.0 x 3.50 in 279 x 88.9 mm
Mounting	1 1/4 -12 Thread	1 1/4 -12 Thread	1 3/4 -12 Thread	2 3/4 -8 Thread
Electrical Connector	PT02E-10-6P	PT02E-10-6P	PT02E-10-6P	PT02E-10-6P
Supplied Accessory				
Shunt Calibration Resistor	Yes	Yes	Yes	Yes
Additional Versions				
Alternate Electrical Connector	1404-02B PC04E-10-6P	1404-03B PC04E-10-6P	1408-02B PC04E-10-6P	1411-02B PC04E-10-6P
Alternate Attachment Threads	M1404-02A M1404-02B M33 x 2-4H	M1404-03A M1404-03B M33 x 2-4H	M1408-02A M1408-02B M42 x 2-4H	M1411-02A M1411-02B M72 x 2-4H
Available Accessories				
Mounting Bases	084A101 M084A101	084A101 M084A101	084A103 M084A103	084A104 M084A104
Mating Electrical Connectors	181-012A (PT) 182-025A (PC)	181-012A (PT) 182-025A (PC)	181-012A (PT) 182-025A (PC)	181-012A (PT) 182-025A (PC)
Recommended Cables	8311-01-10A (PT) 8315-01-10A (PC)	8311-01-10A (PT) 8315-01-10A (PC)	8311-01-10A (PT) 8315-01-10A (PC)	8311-01-10A (PT) 8315-01-10A (PC)
Note				
[1] Calibrated at 10 VDC, useable 5 to 20 VDC or VAC RMS				

S-Type Load Cells

Highlights:

- High accuracy
- Durable
- Rugged
- NIST traceable calibration

S-Type Load Cells are extremely accurate strain gage sensors used for weighing and general force measurement. Their high accuracy makes them ideally suited for critical weighing applications. Integral six foot cable with pigtail leads, stripped and tinned, is provided for electrical interface.

S-Type Load Cells



Model Number	1630-03C	1630-04C	1630-06C
Measurement Range	50 lbf 222 N	100 lbf 445 N	250 lbf 1112 N
Overload Limit	75 lbf 330 N	150 lbf 640 N	350 lbf 1500 N
Sensitivity	2 mV/V	2 mV/V	2 mV/V
Non-Linearity	≤ 0.15% FS	≤ 0.15% FS	≤ 0.15% FS
Hysteresis	≤ 0.15% FS	≤ 0.15% FS	≤ 0.15% FS
Non-Repeatability	≤ 0.05% FS	≤ 0.05% FS	≤ 0.05% FS
Temperature Range	0 to +200 °F -18 to +93 °C	0 to +200 °F -18 to +93 °C	0 to +200 °F -18 to +93 °C
Temperature Range Compensated	+75 to +150 °F +21 to +65 °C	+75 to +150 °F +21 to +65 °C	+75 to +150 °F +21 to +65 °C
Bridge Resistance	350 Ohm	350 Ohm	350 Ohm
Excitation Voltage [1]	10 VDC	10 VDC	10 VDC
Size (H x W x D)	2.5 x .75 x 2 in 64 x 19 x 51 mm	2.5 x .625 x 2 in 64 x 16 x 51 mm	2.5 x .625 x 2 in 64 x 16 x 51 mm
Mounting	1/4-28 Thread	1/4-28 Thread	1/4-28 Thread
Electrical Connector	10 ft Integral Cable	10 ft Integral Cable	10 ft Integral Cable
Supplied Accessory			
Shunt Calibration Resistor	Yes	Yes	Yes
Additional Version			
Alternate Attachment Thread	M1630-03C M6 x 1-6H	M1630-04C M6 x 1-6H	M1630-06C M6 x 1-6H
Note			
[1] Calibrated at 10 VDC, useable 5 to 20 VDC or VAC RMS			

S-Type Load Cells

Applications

- Weighing
- Material Testing
- Tensile Test Machines
- Assembly Forces
- General Force Measurements

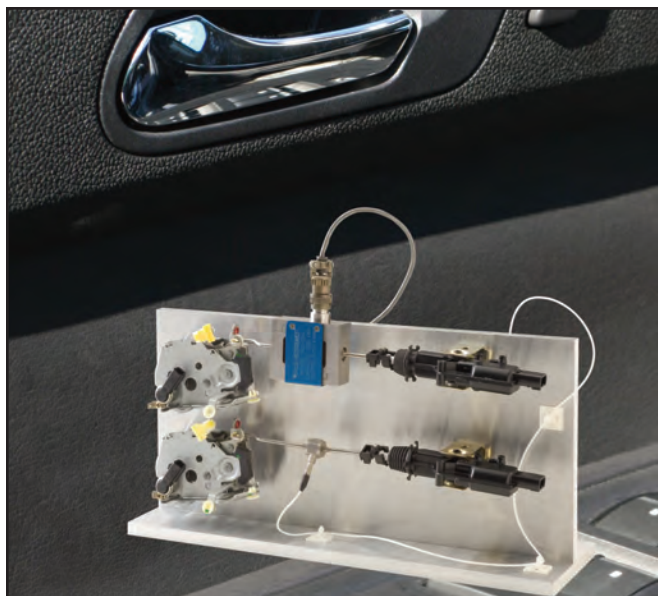

S-Type Load Cells



Model Number	1631-01C	1631-03C	1631-04C	1631-06C	1621-02A
Measurement Range	500 lbf 2.2 kN	1k lbf 4.5 kN	2k lbf 8.9 kN	5k lbf 22 kN	1k lbf 4.5 kN
Overload Limit	750 lbf 3.3 kN	1.5k lbf 6.7 kN	3k lbf 13.3 kN	7.5k lbf 33.5 kN	5k lbf 22 kN
Sensitivity	2 mV/V	2 mV/V	2 mV/V	2 mV/V	2 mV/V
Non-Linearity	≤ 0.15% FS	≤ 0.15% FS	≤ 0.15% FS	≤ 0.15% FS	▲ 0.05% FS
Hysteresis	≤ 0.15% FS	≤ 0.15% FS	≤ 0.15% FS	≤ 0.15% FS	▲ 0.05% FS
Non-Repeatability	≤ 0.05% FS	≤ 0.05% FS	≤ 0.05% FS	≤ 0.05% FS	▲ 0.02% FS
Temperature Range	0 to +200 °F -18 to +93 °C	0 to +200 °F -18 to +93 °C	0 to +200 °F -18 to +93 °C	0 to +200 °F -18 to +93 °C	+65 to +200 °F +54 to +93 °C
Temperature Range Compensated	+75 to +150 °F +21 to +65 °C	+75 to +150 °F +21 to +65 °C	+75 to +150 °F +21 to +65 °C	+75 to +150 °F +21 to +65 °C	+70 to +170 °F +21 to +76 °C
Bridge Resistance	350 Ohm	350 Ohm	350 Ohm	350 Ohm	350 Ohm
Excitation Voltage [1]	10 VDC	10 VDC	10 VDC	10 VDC	10 VDC
Size (H x W x D)	3.0 x 1.0 x 2.0 in 76 x 25 x 51 mm	3.0 x 1.0 x 2.0 in 76 x 25 x 51 mm	3.0 x 1.0 x 2.0 in 76 x 25 x 51 mm	3.5 x 1.5 x 2.5 in 89 x 38 x 64 mm	2.3 x 1 x 2.8 in 57 x 25 x 70 mm
Mounting	1/2-20 Thread	1/2-20 Thread	1/2-20 Thread	5/8-18 Thread	1/2-20 Thread
Electrical Connector	10 ft Integral Cable	10 ft Integral Cable	10 ft Integral Cable	10 ft Integral Cable	21R-10-6P
Supplied Accessory					
Shunt Calibration Resistor	Yes	Yes	Yes	Yes	Yes
Additional Version					
Alternate Attachment Thread	M1631-01C M12 x 1.75-6H	M1631-03C M12 x 1.75-6H	M1631-04C M12 x 1.75-6H	M1631-06C M12 x 1.75-6H	—
Note					
[1] Calibrated at 10 VDC, useable 5 to 20 VDC or VAC RMS					

Rod End Load Cells

Highlights:

- Rugged design
- Sealed construction
- Fully calibrated in both tension and compression
- NIST traceable calibration
- Built-in temperature compensation

Rod End Load Cells are designed for integration into tension measurement applications such as process automation, quality assurance, and production monitoring. Standard 3/4-16 and 1-14 Male/Female threads facilitate ease of installation.

Rod End Load Cells



Model Number	1380-01A	1380-02A	1380-03A	1381-01A	1381-02A	1381-04A
Measurement Range	500 lbf 2.2 kN	1k lbf 4.5 kN	2k lbf 8.9 kN	5k lbf 22.2 kN	10k lbf 44.5 kN	20k lbf 89 kN
Overload Limit	750 lbf 3.3 kN	1.5k lbf 6.7 kN	3k lbf 13.3 kN	7.5k lbf 33.4 kN	15k lbf 66.7 kN	30k lbf 133.5 kN
Sensitivity	2 mV/V	2 mV/V	2 mV/V	2 mV/V	2 mV/V	2 mV/V
Non-Linearity	≤ 0.25% FS	≤ 0.25% FS	≤ 0.25% FS	≤ 0.25% FS	≤ 0.25% FS	≤ 0.25% FS
Hysteresis	≤ 0.25% FS	≤ 0.25% FS	≤ 0.25% FS	≤ 0.25% FS	≤ 0.25% FS	≤ 0.25% FS
Non-Repeatability	≤ 0.15% FS	≤ 0.15% FS	≤ 0.15% FS	≤ 0.15% FS	≤ 0.15% FS	≤ 0.15% FS
Temperature Range	0 to +200 °F -18 to +93 °C	0 to +200 °F -18 to +93 °C	0 to +200 °F -18 to +93 °C	0 to +200 °F -18 to +93 °C	0 to +200 °F -18 to +93 °C	0 to +200 °F -18 to +93 °C
Temperature Range Compensated	+70 to +150 °F +21 to +66 °C	+70 to +150 °F +21 to +66 °C	+70 to +150 °F +21 to +66 °C	+70 to +150 °F +21 to +66 °C	+70 to +150 °F +21 to +66 °C	+70 to +150 °F +21 to +66 °C
Bridge Resistance	350 Ohm	350 Ohm	350 Ohm	350 Ohm	350 Ohm	350 Ohm
Excitation Voltage [1]	10 VDC	10 VDC	10 VDC	10 VDC	10 VDC	10 VDC
Size (Diameter x Height)	1.50 x 4.25 in 38.1 x 107.9 mm	1.50 x 4.25 in 38.1 x 107.9 mm	1.50 x 4.25 in 38.1 x 107.9 mm	1.50 x 4.5 in 38.1 x 114.3 mm	1.50 x 4.5 in 38.1 x 114.3 mm	1.50 x 4.5 in 38.1 x 114.3 mm
Mounting	3/4 - 16 Thread	3/4 - 16 Thread	3/4 - 16 Thread	1 - 14 Thread	1 - 14 Thread	1 - 14 Thread
Electrical Connector	PT02E-10-6P	PT02E-10-6P	PT02E-10-6P	PT02E-10-6P	PT02E-10-6P	PT02E-10-6P
Supplied Accessory						
Shunt Calibration Resistor	Yes	Yes	Yes	Yes	Yes	Yes
Additional Accessories						
Mating Electrical Connector	181-012A (PT)	181-012A (PT)	181-012A (PT)	181-012A (PT)	181-012A (PT)	181-012A (PT)
Recommended Cable	8311-01-10A	8311-01-10A	8311-01-10A	8311-01-10A	8311-01-10A	8311-01-10A
Note						
[1] Calibrated at 10 VDC, useable 5 to 20 VDC or VAC RMS						

Recommended Signal Conditioners for Load Cells



Series 8161

Provides 5 or 10 VDC bridge excitation, and delivers ± 5 or ± 10 volts and 4-20 mA output signals, and operates from 12 to 28 VDC power. Adjustable zero and span with built-in shunt calibration.



Series 8159

Provides 5 or 10 VDC strain gage bridge excitation which delivers ± 10 VDC and 4 to 20 mA output signals, and operates from 115 or 230 VAC power.



Series 8162

In-line, IP66 enclosure, operates from 12 to 18 VDC, provides 10 VDC sensor excitation, delivers ± 10 V and 4 to 20 mA outputs.

Accessories

Cable Assemblies

- 8311-17-XXA
- 8311-18-XXA
- 8311-15-XXA



Cable Assemblies 8311-01-XXA



Load Button Series C-20099-XX

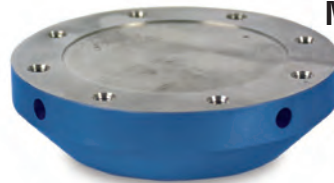

Mounting Base

- 084A100
- 084A101
- 084A103
- 084A104



Rod End Series A-20357-XA



Connector 181-012A



Connector 181-025A

TORKDISC® In-line Rotary Torque Sensor System

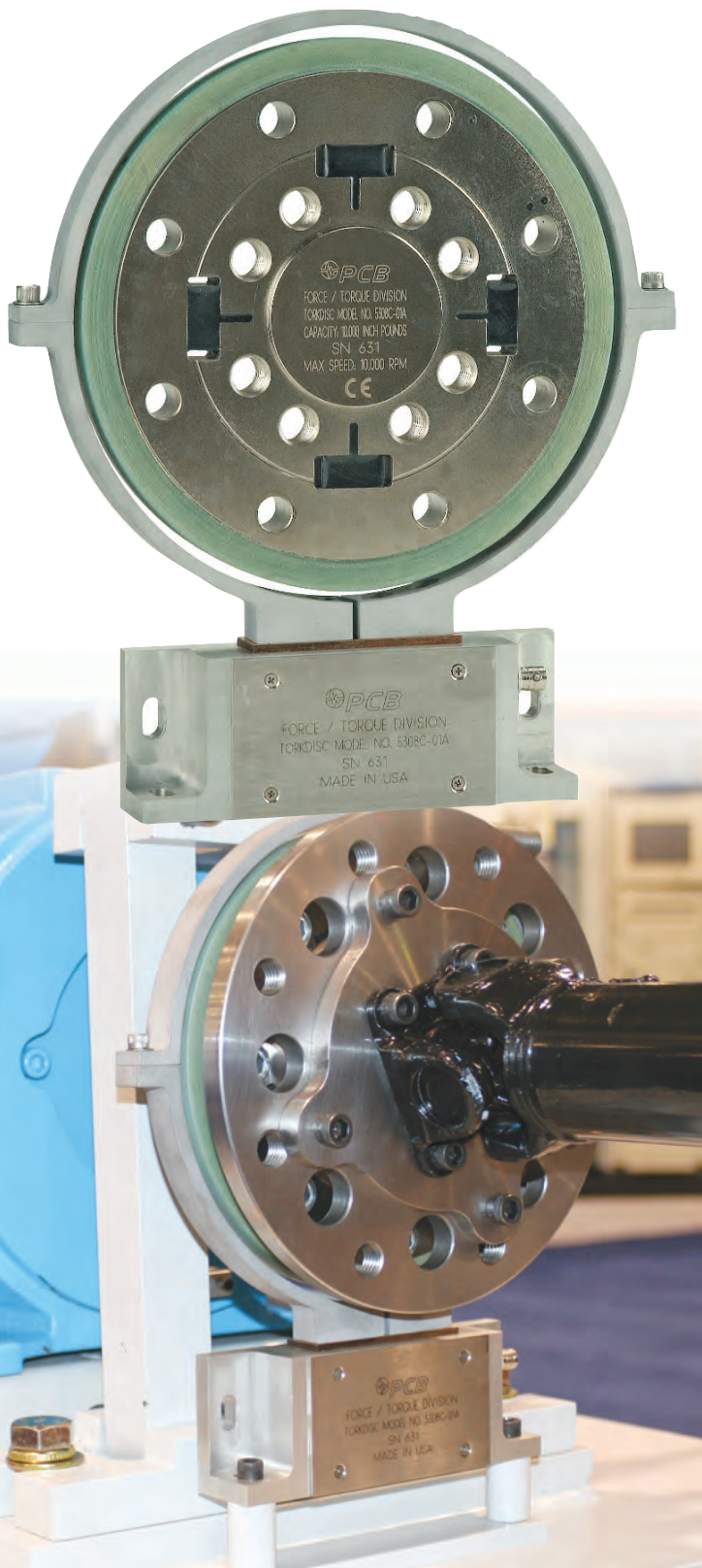

Highlights:

- AC coupled, 0 to ± 10 volt analog output with 2-pole Butterworth high pass filter with user selectable cut off frequencies
- DC coupled, 0 to ± 10 volt analog output with 8-pole elliptical low pass filter with user selectable cut off frequencies
- Digital system alleviates noise & data corruption
- High torsional stiffness
- DC to 8500 Hz bandwidth
- Immune to RF & EMI
- Maintenance free
- High bending moment capability
- CE certified

PCB® Series 5300 TORKDISC® In-line Rotary Torque Sensor Systems are designed for test applications requiring a robust rotary torque transducer where axial space is at a premium. Onboard, the transducer is a field proven electronic module that converts the torque signals into a high-speed digital representation. Once in digital form, this data is transmitted to a non-contacting pick-up head, with no risk of noise or data corruption. A remote receiver unit converts the digital data to a high-level analog output voltage.

Series 5300 systems incorporate dual high level analog outputs, AC and DC coupled, providing both static and dynamic torque measurement capability that can be recorded separately and independently scaled; which is particularly beneficial when high DC levels are present or when low levels of AC content is of particular interest. Series 5300 systems also feature industry leading bandwidth DC to 8500 Hz, resulting in increased dynamic response characteristics. The DC coupled output features an 8-pole, low-pass, elliptical filter with user selectable frequencies for minimal roll off at each filter selection. A 2-pole Butterworth high-pass filter with a wide range of user selectable cut off frequencies is included with the AC coupled output.

TORKDISC® In-line Rotary Torque Sensor System



TipsFromTechs

When planning the installation of the TORKDISC®, design mating fixtures to create a one inch axial air gap around the rotating antenna and stationary pick-up head. The air gap is required to ensure no bleed-off of the inductive power to surrounding metallic surfaces that are larger in diameter than the metallic portion of the rotating sensor itself.

TORKDISC® Rotary Torque Sensor System

Model Number	Unit	5302D-05A	5302D-03A	5302D-01A	5302D-02A
Continuous Rated Capacity	in-lb	250	1000	2000	5000
	N-m	28	113	226	565
Bolt Joint Slip Torque [1]	in-lb	825	3300	3300	10k
	N-m	93	373	373	1130
Safe Overload	in-lb	750	3000	6000	15k
	N-m	85	339	678	1695
Failure Overload	in-lb	1000	4000	8000	20k
	N-m	113	452	904	2260
Torsional Stiffness	in-lb/rad	300k	2.9M	5.8M	14.5M
	N-m/rad	34k	328k	655k	1.6M
Torsional Angle @ Capacity	degrees	0.125	0.02	0.02	0.02
Rotating Inertia	in-lb sec ²	0.030	0.056	0.056	0.117
	N-m sec ²	0.003	0.006	0.006	0.013
Axial Load Limit [2]	lb	62.5	250	500	1000
	N	278	1112	2224	4448
Lateral Load Limit [2]	lb	62.5	250	500	1000
	N	278	1112	2224	4448
Bending Moment Limit [2]	in-lb	125	750	1500	3000
	N-m	14	85	169	339
Maximum Speed	RPM	15k	15k	15k	15k
Rotor Weight	lb	2	3.5	3.5	9
	kg	0.91	1.59	1.59	4.08
Rotor Material		Aluminum	Aluminum	Aluminum	Steel

TORKDISC® Rotary Torque Sensor System

Model Number	Unit	5302D-04A	5308D-01A	5308D-02A	5308D-03A
Continuous Rated Capacity	in-lb	6250	10k	20k	30k
	N-m	706	1130	2260	3400
Bolt Joint Slip Torque [1]	in-lb	10k	35k	35k	35k
	N-m	1130	3955	3955	4000
Safe Overload	in-lb	15k	30k	60k	75k
	N-m	1695	3390	6779	8475
Failure Overload	in-lb	20k	40k	80k	100k
	N-m	2260	4519	9039	11.3k
Torsional Stiffness	in-lb/rad	14.5M	33.5M	67M	100M
	N-m/rad	1.6M	3.8M	7.6M	11.3M
Torsional Angle @ Capacity	degrees	0.02	0.017	0.017	0.017
Rotating Inertia	in-lb sec ²	0.117	0.24	0.24	0.24
	N-m sec ²	0.013	0.027	0.027	0.027
Axial Load Limit [2]	lb	1000	1350	2700	4000
	N	4448	6000	12k	17.8k
Lateral Load Limit [2]	lb	1000	1650	3375	5000
	N	4448	7300	15k	22.2k
Bending Moment Limit [2]	in-lb	3000	5000	9500	10k
	N-m	339	565	1073	1130
Maximum Speed	RPM	15k	10k	10k	10k
Rotor Weight	lb	9	10	10	10
	kg	4.08	4.5	4.5	4.5
Rotor Material		Steel	Steel	Steel	Steel

Notes

[1] Bolt joint slip torque is calculated assuming a coefficient of friction (μ) of 0.1 and that grade 8 socket head cap screws are used and tightened to 75% of yield for steel sensors and 30% of yield for aluminum sensors. Model 5309D-02A requires the use of Supertanium bolts on the inner bolt circle diameter to maintain proper clamping frictional forces, tightened to 70% of yield.
 [2] Extraneous load limits reflect the maximum axial load, lateral load, and bending moment that may be applied singularly without electrical or mechanical damage to the sensor. Where combined extraneous loads are applied, decrease loads proportionally. Request Application Note AP-1015 regarding the effects of extraneous loads on the torque sensor output.

TORKDISC® In-line Rotary Torque Sensor System

Applications:

- Rotational Dynamics Test
- Torque Studies on Pumps, Fans, & Electric Motors
- Gear Box Efficiency Testing
- Engine Development
- Chassis Dynamometer
- Torque to Turn
- Production Testing
- Gear Mesh Evaluation

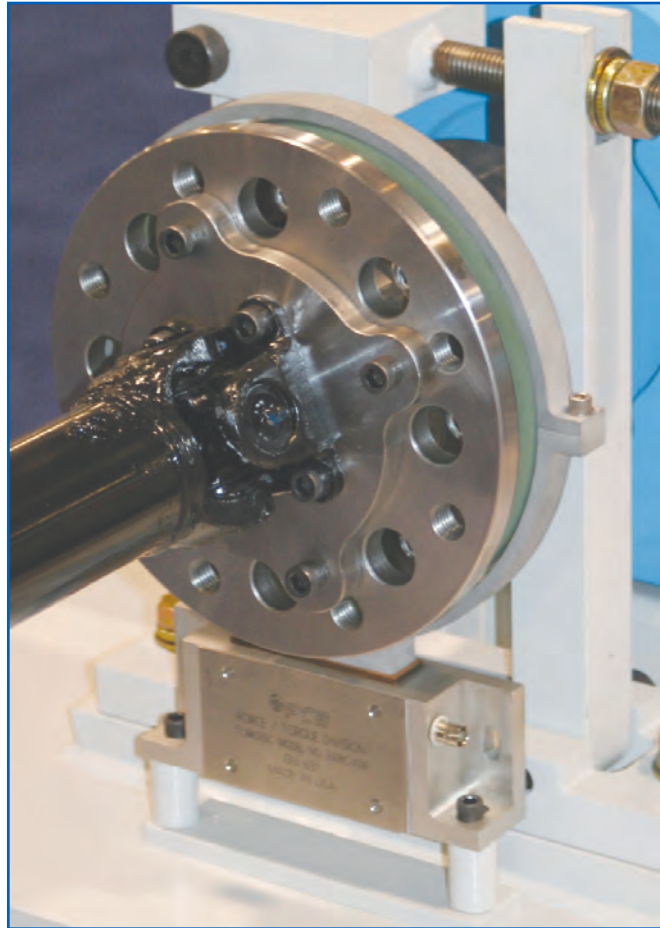

Series 5300D Common Specifications

System Output		Temperature	
Voltage Output A	AC Coupled, 0 to ± 10 volt w/ independent coarse gain control (16 increments)	Rotor Temp. Range Compensated	+70 to +170 °F (+21 to +77 °C)
Voltage Output B	DC Coupled, 0 to ± 10 volt w/ independent fine and coarse gain control	System Temp. Effect on Output [2]	± 0.002% FS/°F (± 0.0036% FS/°C)
Digital Output:	QSPI	System Temp. Effect on Zero [2]	± 0.002% FS/°F (± 0.0036% FS/°C)
System Performance		Rotor/Stator Temp. Range Usable	+32 to +185 °F (0 to +85 °C)
Accuracy	Overall, 0.1% FS, combined effect of Non-Linearity, Hysteresis, & Repeatability	Rotor/Stator Optional Temp. Range Usable	+32 to +250 °F (0 to +121 °C)
Voltage Output A Filter (AC)	2-pole Butterworth high pass w/ selectable cutoff frequencies of 5, 10, 20, 200, 500, & 735 Hz, & 8-pole low pass determined by the DC coupled output cutoff frequency selection	Receiver Temp. Range Usable	0 to +122 °F (-17 to +50 °C)
Voltage Output B Filter (DC)	8-pole elliptical low pass w/selectable cutoff frequencies of > 8.5k, 5k, 2.5k, 1.25k, 625, 313, 10, & 1 Hz	Mechanical	
Bandwidth	DC to 8500 Hz anti-alias	Permissible Radial Float, Rotor to Stator	± 0.25 in (± 6.35 mm)
Digital resolution	16-bit [1]	Permissible Axial Float, Rotor to Stator	± 0.25 in (± 6.35 mm)
Analog Resolution	0.03195% FS (10 volts/32,768 (16 bit resolution)	Dynamic Balance	ISO G 2.5
Digital Sample Rate	26,484 samples/sec	Sensor Positional Sensitivity	0.1% FS (180° rotation)
Group Delay	110 microseconds at 10 kHz	Power	
Noise	≤10 mV at 10 kHz	Power Requirements	9 to 18 VDC, 15 watts (90 to 240VAC 50-60 Hz, adaptor is supplied)
Noise Spectral Density	< 0.0005%FS per root Hz typical	Miscellaneous	
		Symmetry Adjustment	Factory and user adjustable ± 0.5% FS
		Supplied Cable, Stator to Receiver	24 ft. (7.3 m), RG 58/U (BNC plug/stator side, TNC plug/receiver side)
		Optional Cable, Stator to Receiver	80 ft. (24.4 m), RG 58/U (contact factory for longer lengths)
		Output Interface	DB-25 female connector (mating supplied w/backshell)
		Calibration	Unipolar shunt calibration, invoked from the receiver front panel
		Stator Assembly	Top half of loop is removable for easy installation over rotor
		Notes	
		[1] Actual resolution is 15 bit, 1 bit for polarity [2] Within compensated range	

TORKDISC® In-line Rotary Torque Sensor System

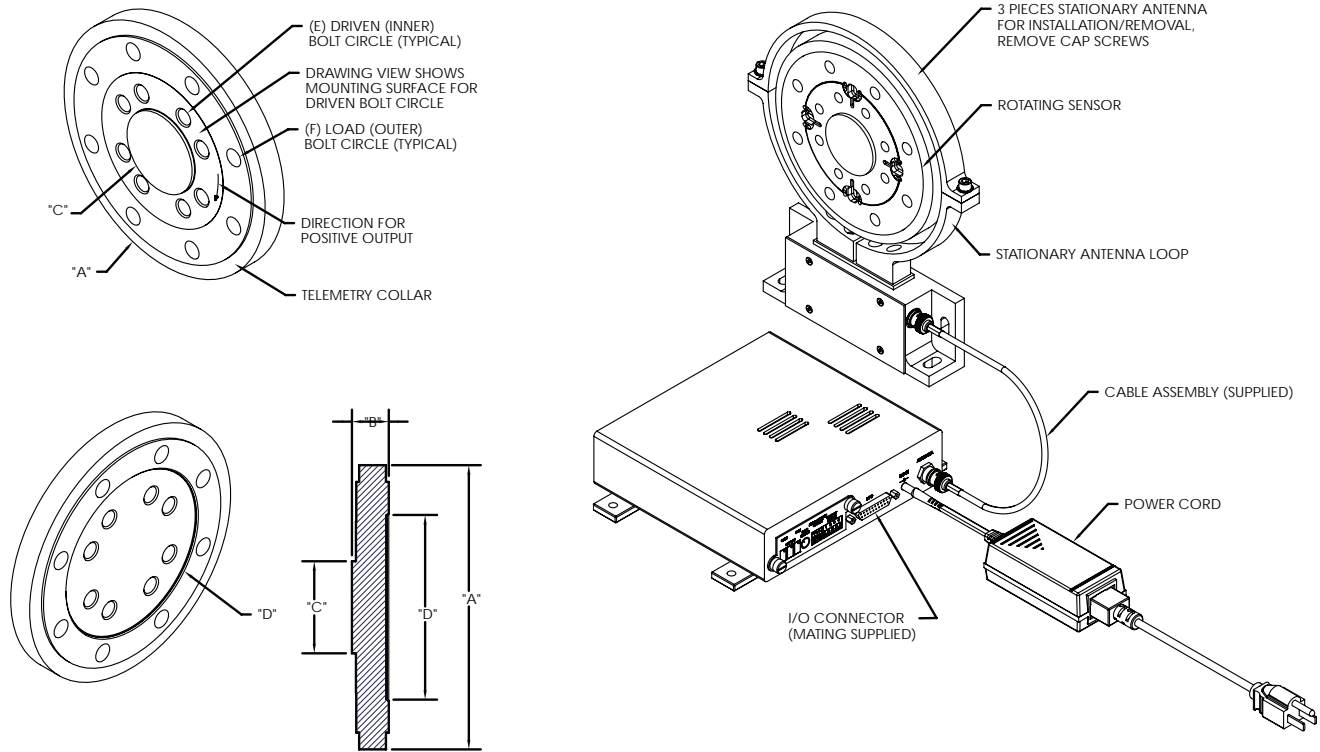

The TORKDISC® and receiver make up a complete system. No additional signal conditioning is required. The receiver box provides voltage and digital output via a 25-pin I/O connector.

TORKDISC® Sensor Dimensions

	A	B	C	D	E	F
Series	O.D. - Outside Diameter (including telemetry collar)	Overall Thickness	Pilot	Pilot	Driven (inner) Bolt Circle	Load (outer) Bolt Circle
5302D	7.00 in 177.8 mm	1.10 in 27.9 mm	1.999 in 50.8 mm	4.375 in 111.1 mm	(8) 3/8-24 threaded holes, equally spaced on a 3.00 in (76.20 mm) B.C.	(8) 0.406 in (10.31 mm) dia through holes equally spaced on a 5.00 in (127.0 mm) B.C.
5308D	8.49 in 215.5 mm	1.10 in 27.9 mm	2.748 in 69.8 mm	5.513 in 140.0 mm	(8) 5/8-11 threaded holes, spaced on a 3.75 in (95.25 mm) B.C.	(8) 0.531 in (13.49 mm) dia through holes equally spaced on a 6.5 in (165.0 mm) B.C.

Tips From Techs

Best practice in dynamometer use is to install the male pilot side of the TORKDISC® toward the unit under test via a drive shaft with either universal or constant velocity joints to allow for misalignment that may occur due to vibration or temperature expansion and contraction. The female pilot side is then typically rigidly mounted on the reaction or absorption side. Note: The TORKDISC® will produce at positive polarity in this setup when torque is applied in the clockwise direction.

Single Channel Telemetry Systems

Highlights

- Compact size, light weight
- Easy to use, wear and maintenance free
- Extremely robust, dust and water proof
- Contact free signal transmission
- Remote shunt calibration
- Can be configured for strain gage, thermocouple, thermistor and voltage
- Adjustable output
- Inductive power provides continuous operation

Applications

- Drive Shaft Testing
- Steering Column Testing
- Brake Testing
- Bearing Temperature Testing
- Assembly Line Testing
- Automotive
- Aerospace & Defense
- Wind Power Plant
- Test Benches
- Industrial Testing

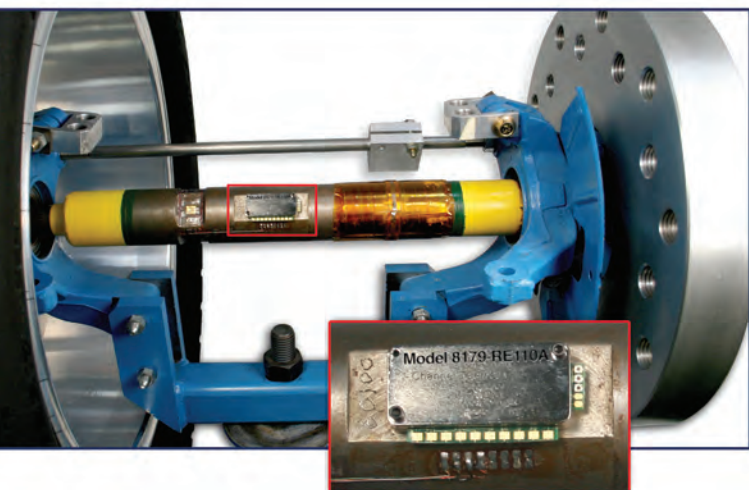
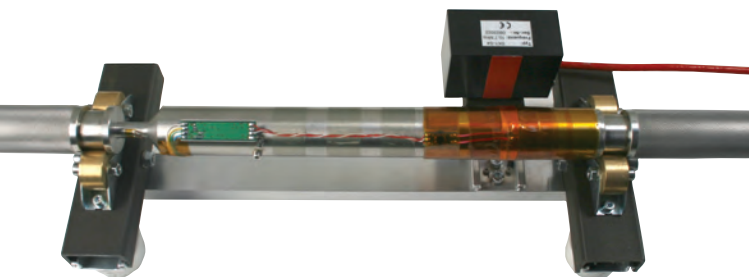
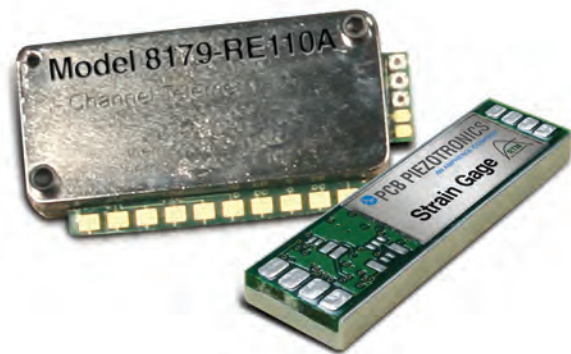

PCB® Series 8179 & 8180 Single Channel Telemetry Systems provide a simple, accurate method of conditioning and transmitting strain, thermocouple, voltage, or ICP® signals on rotating or moving machinery while operating in a completely contactless mode. Power is transferred inductively and the signal is RF-transferred between the moving and static component - no brushes or wires required. This method guarantees an absolute maintenance-free continuous operation and accurate transmission of measured data.

These Single Channel Telemetry Systems are compact in size and light weight which allows for quick and easy installations in areas where space is at a premium without affecting the dynamic properties of the shaft. Power transmission to the rotor electronics and return signal transmission to the stator is accomplished via a transmission band wrapped around the shaft and used as an antenna. The flat antenna structure permits generous axial and radial clearance. Alternatively, power can be derived from an on-shaft battery.

Data is transmitted contact-free from the antenna to the stator and then to the control unit, where it is demodulated and converted back to an analog value. The signals can be read directly on the control unit display or fed into further acquisition equipment.

PCB® Series 8179 also includes a remote shunt calibration feature that enables strain gage configurations to be checked, even during measurement. PCB® Series 8180 performs a remote shunt calibration when the unit is powered up.

As with all PCB® instrumentation, these telemetry systems are complemented with toll-free applications assistance 24-hour customer service, and are backed by a no-risk policy that guarantees total customer satisfaction.

Single Channel Telemetry Systems

Rotor		
Series Number	8179-RE1	8180-RE1
Dimensions	1.9 x .9 x .3 in 48 x 24 x 8 mm	1.6 x .5 x 1.4 in 40 x 12 x 3.5 mm
Weight	0.5 oz 15 gm	0.14 oz 4 gm
Sensors	Strain, Thermocouple, RTD (PT100), Voltage	Strain or Thermocouple or Voltage or ICP® [1]
Strain Gage Configuration	Full Bridge	Full/Half Bridge
Bandwidth	1000 Hz	1000 Hz
Operating Temperature	+32 to +176 °F 0 to +80 °C	+32 to +176 °F 0 to +80 °C
Option	-40 to +248 °F -40 to +120 °C	-40 to +248 °F -40 to +120 °C
Note		
[1] Please specify version at time of order.		



Model 8180-SH1



Model 8180-SH2



Model 8180-SH4

Stator			
Model Number	8180-SH1	8180-SH2	8180-SH4
Dimensions	1.4 x 2.0 x 2.8 in 35 x 50 x 70 mm	1.0 x 1.2 x 1.8 in 25 x 30 x 45 mm	2.0 x 2.0 x 1.4 in 50 x 50 x 35 mm
Inductive Power	Yes	Yes	Yes
Distance to shaft	1.5 in 38 mm	0.4 in 10 mm	7.9 in 200 mm
Operating Temperature	-40 to +248 °F -40 to +120 °C	-40 to +248 °F -40 to +120 °C	-40 to +248 °F -40 to +120 °C



Model 8179-CURO



Model 8179-CUTO



Model 8180-CUTO

Receiving Unit			
Model Number	8179-CUTO	8179-CURO [1]	8180-CUTO
Dimensions	4.1 x 2.5 x 7.2 in 105 x 64.5 x 184 mm	2.8 x 5.0 x 6.7 in 70.8 x 128 x 171 mm	7.9 x 4.1 x 2.5 in 200 x 105 x 64 mm
Note			
[1] An optional 19" housing is available for multiple 8179-CURO units.			

Electronics



To insure a quality product, Nugget Mandolin uses PCB® sensors to perform a precision modal test.

Highlights:

- Battery-Powered ICP®
- Sensor Signal Conditioners
- DC-Powered ICP® Sensor Signal Conditioners
- Line-Powered ICP® Sensor Signal Conditioners
- Multi-Channel ICP® Sensor Signal Conditioners
- DC-Coupled ICP® Sensor Signal Conditioners
- Modular-Style ICP® Sensor Signal Conditioners
- In-Line ICP®-Powered Charge Converters
- Industrial Charge Amplifiers
- Differential Charge Amplifiers
- In-line Bridge Converters
- MEMS Sensor Signal Conditioners







Photo Courtesy of Nugget Mandolins



Battery-powered ICP® Sensor Signal Conditioners

Battery-Powered ICP® Sensor Signal Conditioners

				
Model Number	480C02	480E09	480B10	480B21
Channels	1	1	1	3
Sensor Input Type	ICP®	ICP®	ICP®	ICP®
Gain	Unity	x1, x10, x100	Unity	x1, x10, x100
Integration	—	—	Accel., Vel., Disp.	—
Low Frequency Response (-5%)	0.05 Hz [1]	0.15 Hz [1]	0.07 (a), 8 (v), 15 (d) Hz [4]	0.15 Hz [1]
High Frequency Response (-5%) (Unity Gain)	500 kHz	100 kHz	100 (a), 10 (v), 1 (d) kHz	100 kHz
Temperature Range	+32 to +122 °F 0 to +50 °C	+32 to +122 °F 0 to +50 °C	+32 to +122 °F 0 to +50 °C	+32 to +122 °F 0 to +50 °C
Power Required (Internal Batteries)	(3) 9 VDC	(3) 9 VDC	(2) 9 VDC	(3) 9 VDC
Battery Life (Standard Alkaline)	100 Hours	50 Hours	≥ 30 Hours	25-40 Hours
Excitation Voltage	25 to 29 VDC	25 to 29 VDC	16 to 19 VDC	25 to 29 VDC
Constant Current Excitation	2.0 to 3.2 mA [2]	2.0 to 3.2 mA [2]	1.4 to 2.6 mA [2]	2.0 to 3.2 mA [2]
DC Offset	≤ 30 mV [1]	≤ 30 mV [1]	≤ 30 mV [1]	≤ 30 mV [1]
Broadband Electrical Noise (Gain x1)	3.25 μV rms [3]	3.25 μV rms [1]	—	3.54 μV rms [1]
Input/Output Connectors	BNC Jacks	BNC Jacks	BNC Jacks	BNC Jacks (i/o); 4-Pin Jack (i) [5]
External DC Power Input	Yes	Yes	No	Yes
DC Power Input Connector	3.5mm dia. Mini Jack	3.5mm dia. Mini Jack	—	6-Pin Mini DIN
Size	4 x 2.9 x 2.2 in 10 x 7.4 x 5.6 cm	4 x 2.9 x 2.4 in 10 x 7.4 x 6.1 cm	4 x 2.9 x 1.5 in 10 x 7.4 x 3.8 cm	7.5 x 5 x 2 in 19 x 13 x 5 cm
Weight	0.7 lb 300 gm	0.7 lb 300 gm	0.61 lb 276.4 gm	1.1 lb 500 gm
Additional Versions				
Rechargeable [6]	R480C02	R480E09	R480B10	—
4 mA Constant Current	—	480M122	—	—
Additional Accessories				
AC Power Source	488A03 or F488A03	488A03 or F488A03	—	488A10
Battery Charger	488A02 or F488A02	488A02 or F488A02	488A02 or F488A02	—
9 VDC Ultralife Lithium Batteries (3)	400A81	400A81	—	400A81
Auto Lighter 12 VDC Power Adapter	—	—	—	488A12
Notes				
[1] Specified into 1M Ohm load [2] Through internal current limited diode [3] Typical [4] Achieved with accelerometer having a discharge time constant of >1 second and 1M Ohm load impedance [5] Use BNC jacks or 4-pin jack, not both at once. Cover all unused connectors with black ESD protective caps [6] Supplied with 488A02 recharger and (3) 073A09 9 VDC NiCAD batteries				

DC-powered ICP® Sensor Signal Conditioners

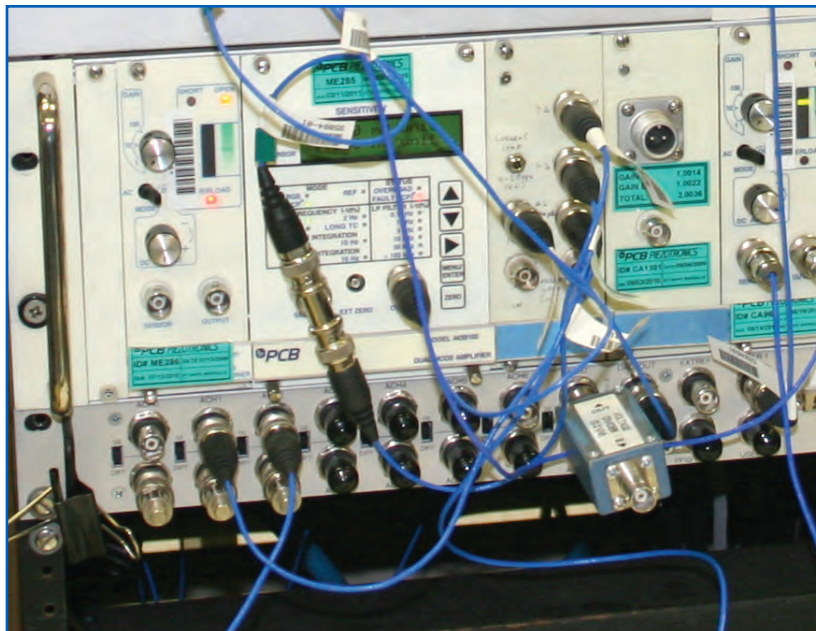

DC-Powered ICP® Sensor Signal Conditioners



CE



Model Number	485B12	485B36
Channels	1	2
Sensor Input Type	ICP®	ICP®
Gain	Unity	Unity
Input Signal Range	± 5 V	± 5 V
Output Range	± 5 V	± 5 V
Low Frequency Response (-5%)	0.05 Hz [1]	1 Hz
High Frequency Response (-5%)	500 kHz [2]	50 kHz
Temperature Range	+32 to +122 °F 0 to +50 °C	+32 to +122 °F 0 to +50 °C
Excitation Voltage	18 to 30 VDC	18.5 to 20.5 VDC
Constant Current Excitation	2 to 20 mA [3]	3.8 to 5.8 mA
DC Offset	< 30 mV [1]	< 80 mV
Broadband Electrical Noise (Gain x1) [4]	4 µV rms	6 µV rms
Input Connector	BNC Jack	BNC Jacks
Output Connector	BNC Jack	3.5 mm Stereo Jacks
External DC Power Connector	2 Banana Plugs	USB Connector
External Power Required	Excitation Voltage +2 VDC	5 VDC from USB Port
Size	1.44 x 2.95 x 0.7 in 3.7 x 7.5 x 1.8 cm	1.18 x 3.67 x 1.33 in 3.0 x 9.3 x 3.4 cm
Weight	1.4 oz 40 gm	2.5 oz 70 gm
Supplied Accessory		
Cables	—	009M130 009M131
Additional Version		
10-32 Jack Input Connector	485B	—
Notes		
[1] With 1M Ohm or higher load [2] May be limited by sensor and cable length [3] User adjustable [4] Typical		

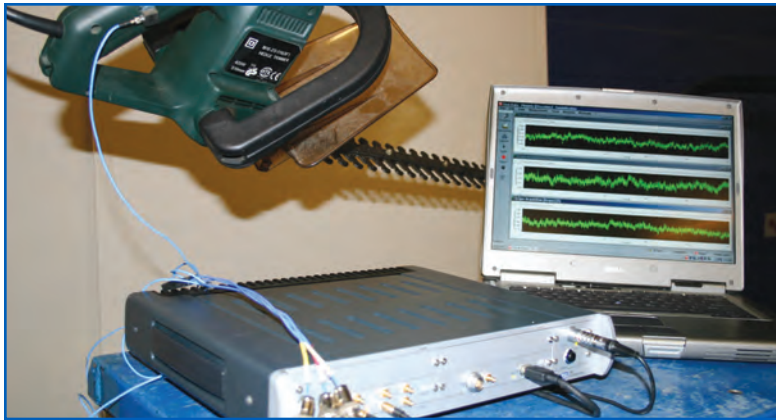

Line-powered ICP® Sensor Signal Conditioners

Line-Powered ICP® Sensor Signal Conditioners

CE



CE



Model Number	482A21	482B11	482C05
Channels	1	1	4
Sensor Input Type(s)	ICP®	ICP®	ICP®, Voltage
Gain	Unity	x1, x10, x100	Unity
Output Range	± 10 V	± 10 V	± 10 V
Low Frequency Response (-5%)	< 0.1 Hz	0.17 Hz	< 0.1 Hz
High Frequency Response (-5%) (Unity Gain)	> 1000 kHz	85 kHz	1000 kHz
Fault/Bias Monitor	Meter	Meter	Open/Short/Overload LEDs
Temperature Range	+32 to +120 °F 0 to +50 °C	+30 to +130 °F -1 to +54 °C	+32 to +120 °F 0 to +50 °C
Power Required (for Supplied AC Power Adaptor)	100 to 240 VAC 47 to 63 Hz	—	100 to 240 VAC 47 to 63 Hz
Power Required (Direct Input to Unit)	+33 to +38 VDC	105 to 125 VAC/ 50 to 400 Hz	+33 to +38 VDC
Excitation Voltage	25 to 27 VDC	+24 VDC	+26 VDC
Constant Current Excitation [1]	2 to 20 mA	2 to 20 mA	0 to 20 mA
DC Offset	≤ 20 mV	≤ 30 mV	≤ 20 mV
Broadband Electrical Noise (Gain x1) [2]	< 3.25 μV rms	< 29 μV rms	3.5 μV rms
Input/Output Connectors	BNC Jacks	BNC Jacks	BNC Jacks
Electrical Connector (DC Power Input)	5-socket DIN	—	5-socket DIN
Size	6.3 x 2.4 x 11 in 16 x 6.1 x 28 cm	4.3 x 1.8 x 6.0 in 10.9 x 4.6 x 15.2 cm	3.2 x 8.0 x 5.9 in 8.1 x 20 x 15 cm
Weight	1.9 lb 861.8 gm	2.00 lb 907.2 gm	2.25 lb 1.021 kg
Supplied Accessories			
Power Cord	017AXX	017AXX	017AXX
Universal Power Adaptor	488B04/NC	—	488B04/NC
Additional Versions			
230 VAC Powered	—	F482B11	—
Internal Jumper Selectable Gain x1, x10, x100	—	—	482C15
Additional Accessories			
Auto Lighter Adapter	488A11	—	488A11
DC Power Pack	488B07	—	488B07
Notes			
[1] User adjustable, factory set at 4 mA (± 0.5 mA). One control adjusts all channels [2] Typical			

Line-powered ICP® Sensor Signal Conditioners



Line-Powered ICP® Sensor Signal Conditioners

CE



CE



TEDS
SENSITIVITY
DATE/TIME







Model Number	482C16	482C54
Channels	4	4
Sensor Input Type(s)	ICP®, Voltage	ICP®, Voltage, Charge
Gain	x0.1 to x200	x0.1 to x200
Output Range	± 10 V	± 10 V
Low Frequency Response (-5%)	0.05 Hz	0.05 Hz
High Frequency Response (-5%) (Unity Gain)	100 kHz	100 kHz
Electrical Filter Corner Frequency (-3dB)	—	10 kHz [3]
Fault/Bias Monitor	Open/Short/Overload LEDs	Open/Short/Overload LEDs
Front Display/Keypad	Yes	Yes
Digital Control Interface	RS-232	RS-232
Temperature Range	+32 to +120 °F 0 to +50 °C	+32 to +120 °F 0 to +50 °C
Power Required (for Supplied AC Power Adaptor)	100 to 240 VAC/ 50 to 60 Hz	100 to 240 VAC/ 50 to 60 Hz
Power Required (Direct Input to Unit)	+9 to +18 VDC	+9 to +18 VDC
Excitation Voltage	≥ +24 VDC	≥ +24 VDC
Constant Current Excitation [1]	0 to 20 mA	0 to 20 mA
DC Offset	≤ 50 mV	≤ 50 mV
Broadband Electrical Noise (Gain x1) [2]	10 µV rms	56 µV rms
Input/Output Connectors	BNC Jacks	BNC Jacks
Electrical Connector (DC Power Input)	6-Socket Mini DIN	6-Socket Mini DIN
Electrical Connector (Digital Control)	DB-9 Connector	DB-9 Connector
Size	3.2 x 8.0 x 5.9 in 8.1 x 20 x 15 cm	3.2 x 8.0 x 5.9 in 8.1 x 20 x 15 cm
Weight	2.25 lb 1.021 kg	2.25 lb 1.021 kg
Supplied Accessories		
Power Cord	017AXX	017AXX
Universal Power Adaptor	488B14/NC	488B14/NC
Communication Cable	100-7103-50	100-7103-50
MCSC Control Software	EE75	EE75
Additional Versions		
TEDS Sensor Support	482C26	—
Ethernet Control Interface	—	482C64
Additional Accessory		
Auto Lighter Adapter	488A13	488A13
Notes		

[1] User adjustable, factory set at 4 mA (± 0.5 mA). One control adjusts all channels [2] Typical [3] Frequency tolerance is within ± 5% of the specified value

Multi-channel ICP® Sensor Signal Conditioners



Multi-Channel ICP® Sensor Signal Conditioners

				
				
Model Number	483C05	482A20	483C50	483C30
Channels	8	8	8	8
Sensor Input Type(s)	ICP®, Voltage	ICP®	ICP®, Voltage	ICP®, Voltage, Charge
Gain	Unity	x1, x10, x100	x0.1 to x200	x0.1 to x200
Output Range	10 V	10 V	10 V	10 V
Low Frequency Response (-5%)	0.05 Hz [1]	0.225 Hz	0.05 Hz	0.05 Hz/0.5 Hz [4]
High Frequency Response (-5%) (Unity Gain)	1 MHz	50 kHz	100 kHz [1]	100 kHz [1]
Low Pass Filter	—	—	—	10k Hz [5]
Charge Input Sensitivity	—	—	—	0.1, 1.0, and 10.0 mV/pC
Electrical Isolation (Channel-to-channel Signal Grounds)	—	—	—	Selectable
Fault/Bias Monitor	Open/Short/Overload LEDs	Fault/Overload LEDs	Open/Short/Overload LEDs	Open/Short/Overload LEDs
Front Display/Keypad	—	Keypad only	—	—
Digital Control Interface	—	—	Ethernet	Ethernet
Temperature Range	+32 to +120 °F 0 to +50 °C	+32 to +120 °F 0 to +50 °C	+32 to +120 °F 0 to +50 °C	+32 to +120 °F 0 to +50 °C
Excitation Voltage	+26 VDC	+24 VDC	+24 VDC	+24 VDC
Constant Current Excitation [2]	0 to 20 mA	2 to 20 mA	2 to 20 mA	2 to 20 mA
DC Offset maximum	20 mV	50 mV	50 mV	50 mV
Broadband Electrical Noise (Gain x1) [3]	3.5 µV rms	10 µV rms	10 µV rms	10 µV rms
Input/Output Connectors	BNC Jacks	BNC Jacks	BNC Jacks	BNC Jacks
Size	1.72 x 19 x 13.5 in 4.4 x 48.3 x 34.3 cm	10.5 x 4.25 x 6.2 in 26.7 x 10.8 x 15.8 cm	1.75 in x 19 in x 13.5 in 4.4 cm x 48.3 cm x 34.3 cm	1.75 in x 19 in x 13.5 in 4.4 cm x 48.3 cm x 34.3 cm
Weight	6.25 lb 2.83 kg	6.1 lb 2.8 kg	7 lb 3.2 kg	8 lb 3.6 kg
Supplied Accessories				
Power Cord	017AXX	017AXX	017AXX	017AXX
MCSC Control Software	—	—	EE75	EE75
Additional Versions				
Internal Jumper Selectable x1, x10, x100 Gain	483C15	—	—	—
Unity Gain Only, No Options	—	—	498A01	—
8 to 1 Output Switching	—	482A18	—	—
210 to 250 VAC Powered	—	F482A20	—	—
Notes				
[1] -3dB point [2] User adjustable, factory set at 4 mA [3] Typical [4] ICP® input is 0.05 Hz, charge input is 0.5 Hz [5] Filter can be enabled/disabled				

Multi-channel ICP® Sensor Signal Conditioners

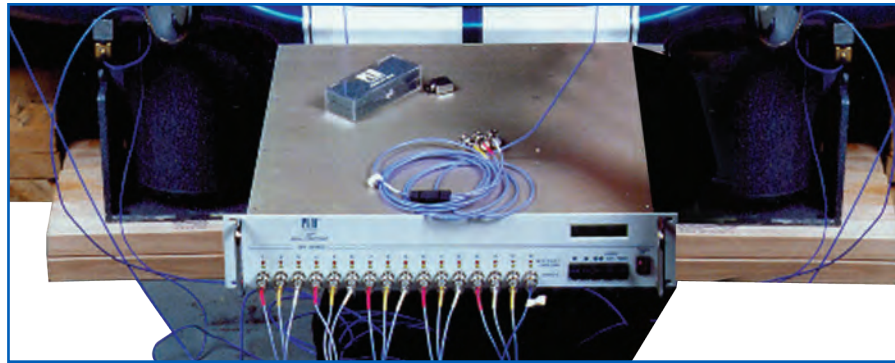

Multi-Channel ICP® Sensor Signal Conditioners

CE



CE



Model Number	481A01	481A02	481A03
Channels	16	16	16
Sensor Input Type	ICP®	ICP®	ICP®
Installed Series Options [1]	080	035, 080, 101, 102, 103	012, 020, 038, 080, 101, 102, 103, 157
Gain	Unity	x1, x10, x100	x0.0025 to x200
Output Range	10 V	10 V	10 V
Low Frequency Response (-5%)	0.5 Hz	0.5 Hz	0.5 Hz
High Frequency Response (-5%) (Unity Gain)	100 kHz	65 kHz	65 kHz
Filtering	—	—	Programmable Low Pass [4]
Internal/External Calibration Function	—	—	Yes
Programmable Overload Level	—	—	Yes
Front Display/Keypad	—	Yes	Yes
Fault/Bias Monitor	Open/Short/Overload LEDs	Open/Short/Overload LEDs	Open/Short/Overload LEDs
Digital Control Interface	—	RS-232	RS-232
Temperature Range	+32 to +120 °F 0 to +50 °C	+32 to +120 °F 0 to +50 °C	+32 to +120 °F 0 to +50 °C
Excitation Voltage	+24 ±1 VDC	+24 ±1 VDC	+24 ±1 VDC
Constant Current Excitation [2]	3 to 20 mA	3 to 20 mA	3 to 20 mA
DC Offset	50 mV	50 mV	50 mV
Broadband Electrical Noise (Gain x1) [3]	11 µV rms	11 µV rms	4 mV rms
Input Connectors	(16) BNC Jacks, (1) DB50 Female	(16) BNC Jacks, (1) DB50 Female	(16) BNC Jacks, (1) DB50 Female
Output Connector	(16) BNC Jacks, (1) DB37 Female	(16) BNC Jacks, (1) DB37 Female	(16) BNC Jacks, (1) DB37 Female
Size	3.5 x 19 x 16.25 in 8.9 x 48.3 x 41.3 cm	3.5 x 19 x 16.25 in 8.9 x 48.3 x 41.3 cm	3.5 x 19 x 16.25 in 8.9 x 48.3 x 41.3 cm
Weight	15 lb 6.82 kg	15 lb 6.82 kg	15 lb 6.82 kg
Supplied Accessories			
Power Cord	017AXX	017AXX	017AXX
Communication Cable	—	009N03	009N03
Ferrite Clamp	100-2973-30	100-2973-30	100-2973-30
MCSC Control Software	—	EE75	EE75
Additional Versions			
High Frequency Version to 1 MHz	481A20	—	—
Base Configurable Model [1]	481A	481A	481A
8-channel	498A01	498A02	498A03
8-channel Dual Mode (ICP®, Charge) with 10k Hz LPF	—	—	498A30
8-channel Base Configurable Model [1]	498A	498A	498A
Notes			
[1] See 481A-498A Series brochure for more information on Series options [2] User adjustable, factory set at 4 mA (± 0.5 mA) [3] Typical [4] Programmable 8th-order Elliptical low pass filter with >500 steps			

DC-coupled ICP® Sensor Signal Conditioners



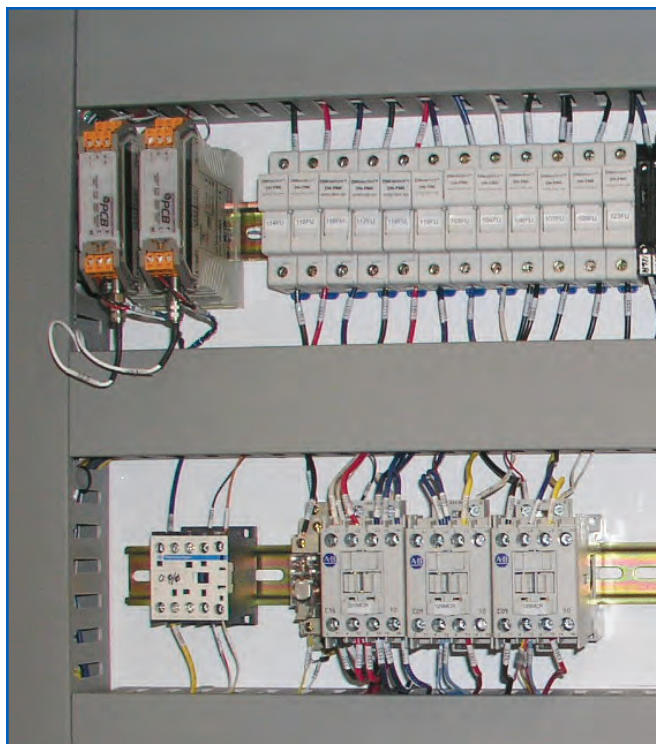
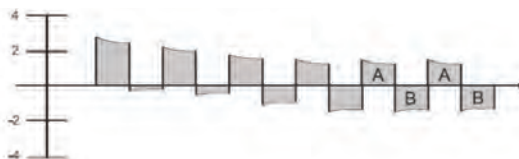

TipsFromTechs

Repetitive Pulse Applications

The output characteristic of piezoelectric sensors is that of an AC coupled system. In repetitive pulse applications, the output signals will decay until there is an equal area above and below the original base line. If only the peak amplitude of each pulse is needed, consider using the models 484B02 with clamped output or 410B01 with reset functions to achieve the correct peak values.



DC-Coupled ICP® Sensor Signal Conditioners

				
Model Number	484B06	484B11	442B06	410B01
Channels	1	1	1	1
Gain	Unity	x1, x10, x100	x1, x10, x100	x0.5, x1, x2, x4, x8, x10, x16, x20
Low Frequency Response (-5%) AC, DC	0.05 Hz, 0 Hz	0.16 Hz, 0 Hz	0.05 Hz, 0 Hz	0.5 Hz, 0 Hz
High Frequency Response (-5%) (Unity Gain)	50 kHz	100 kHz	50 kHz	10 kHz
Temperature Range	+32 to +120 °F 0 to +50 °C	+32 to +120 °F 0 to +50 °C	+32 to +120 °F 0 to +50 °C	+60 to +110 °F +15 to +45 °C
Excitation Voltage	+24 ± 1.0 VDC	+24 ± 1.0 VDC	+24 ± 0.5 VDC	+18 VDC
Constant Current Excitation	2 to 20 mA [1]	2 to 20 mA [1]	1 to 20 mA	4 mA
DC Offset	< 30 mV	< 30 mV	< 50 mV	± 35 mV
Broadband Electrical Noise (Gain x1) [2]	85 µV rms	10 µV rms	9.11 µV rms	20 µV rms
Input/Output Connectors	BNC Jacks	BNC Jacks	BNC Jacks	SMA Jacks, Screw Terminals
Peak Hold Reset Connector	—	—	—	Screw Terminals [3]
Size (Height x Width x Depth)	4.25 x 1.62 x 6.25 in 108 x 41 x 159 mm	4.3 x 1.8 x 6.0 in 109.2 x 45.7 x 152.4 mm	6.2 x 4.25 x 10.2 in 157.5 x 108 x 259.1 mm	4.39 x 0.88 x 3.63 in 111.5 x 22.4 x 92.2 mm
Weight	2 lb 907.2 gm	2 lb 907.2 gm	5.63 lb 2554 gm	0.25 lb 113.4 gm
Supplied Accessories				
Power Cord	017AXX	017AXX	017AXX	017AXX
Ferrite Clamp	—	—	100-2973-30	100-2973-30
Additional Versions				
Clamped Output, 120 VAC Powered	484B02	—	—	—
230 VAC Powered	F484B06	F484B11	—	—
Clamped Output, 230 VAC Powered	F484B02	—	—	—
Notes				
[1] Unit supplied with current set at 4 +/-0.6 mA [2] Typical [3] Optically isolated contact closure				





Modular-style Signal Conditioners

Highlights:

- Powers ICP® and Charge Sensors
- Flexible Modular Design
- Expands Economically as Needs Grow
- Supports TEDS Sensors



Modular-Style Signal Conditioners

				
Model Number	442B02	442C04	443B01	443B02
Channels	1	4	1	1
Sensor Input Type(s)	ICP®	ICP®	Charge Output and ICP®	Charge Output and ICP®
Gain	x1, x10, x100	x1, x10, x100	x0.1 to x1000	x0.1 to x1000
Charge Sensitivity	—	—	0.0001 to 10 V/pC	0.0001 to 10 V/pC
Low Frequency Response (-5%)	0.05 Hz	0.05 Hz	0.2/2 Hz (-10%)	~DC to 2 Hz (-10%)
High Frequency Response (-5%) (Unity Gain)	100 kHz	100 kHz	> 200 kHz	> 200 kHz
Temperature Range	+32 to +120 °F 0 to +50 °C	+32 to +120 °F 0 to +50 °C	+32 to +120 °F 0 to +50 °C	+32 to +120 °F 0 to +50 °C
Excitation Voltage	+24 ±0.5 VDC	+25.5 ±1.5 VDC	+24 ±1.0 VDC	+24 ±1.0 VDC
Constant Current Excitation [1]	1 to 20 mA	0.5 to 20 mA	0, 2, 4, 8, 12, or 20 mA	0, 2, 4, 8, 12, or 20 mA
Broadband Electrical Noise (Gain x1) [2]	9.5 µV rms	9.98 µV rms	9 µV rms	9 µV rms
Input/Output Connectors	BNC Jacks	BNC Jacks	BNC Jacks	BNC Jacks
Size	6.2 x 4.25 x 10.2 in 157.5 x 108 x 259.1 mm	6.2 x 4.25 x 10.2 in 157.5 x 108 x 259.1 mm	6.2 x 6.05 x 10.2 in 157.5 x 153.7 x 259.1 mm	6.2 x 6.05 x 10.2 in 157.5 x 153.7 x 259.1 mm
Weight	4.68 lb 2.12 kg	4.735 lb 2.15 kg	6.15 lb 2.79 kg	6.15 lb 2.79 kg
Supplied Accessories				
Power Cord	017AXX	017AXX	017AXX	017AXX
Ferrite Clamp	100-2973-30	100-2973-30	100-2973-30	100-2973-30
Ferrite Bead	—	—	100-7102-20	100-7102-20
RS-232 Cable	—	—	100-7103-50	100-7103-50
Additional Versions				
8-channel in 3-wide Chassis	—	442C05	—	—
AC/DC Coupled	442B06	—	—	—
Notes				
[1] Unit supplied with current set at 4 mA [2] Typical				

In-line ICP® Powered Charge Converters

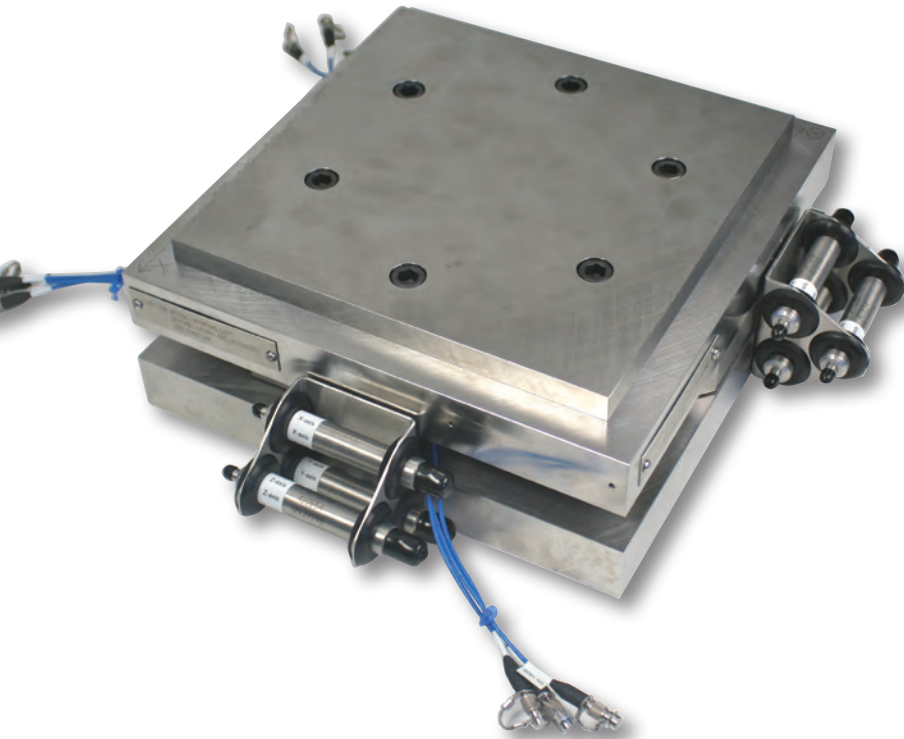

Tips From Techs

Polarity of Charge Converters

The output signal polarity of PCB® charge output sensors is negative. Because of this, most external charge converters, like the 422E Series, are designed to have an inverting characteristic. Therefore, the resulting system, sensor with charge converter, will have an output signal polarity that is positive.

In-Line ICP®-Powered Charge Converters



Model Number	422E51	422E52	422E53	422E55	422E54
Gain (Charge Conversion Sensitivity)	100 mV/pC (±5%)	10 mV/pC (±2.5%)	1 mV/pC (±2.5%)	0.5 mV/pC (±2.5%)	0.1 mV/pC (±2.5%)
Input Range	±50 pC	±500 pC	±5000 pC	±10,000 pC	±50,000 pC
Output Voltage Range	±5.0 V	±5.0 V	±5.0 V	±5.0 V	±5.0 V
Frequency Response (+/-5%) [1]	5 to 100k Hz	5 to 100k Hz	5 to 100k Hz	5 to 50k Hz	5 to 50k Hz
Broadband Electrical Noise [2]	49 µV rms	33 µV rms	33 µV rms	33 µV rms	33 µV rms
Temperature Range	-65 to +250 °F -54 to +121 °C	-65 to +250 °F -54 to +121 °C	-65 to +250 °F -54 to +121 °C	-65 to +250 °F -54 to +121 °C	-65 to +250 °F -54 to +121 °C
Excitation Voltage	18 to 28 VDC	18 to 28 VDC	18 to 28 VDC	18 to 28 VDC	18 to 28 VDC
Constant Current Excitation	2 to 20 mA	2 to 20 mA	2 to 20 mA	2 to 20 mA	2 to 20 mA
Input Connector	10-32 Jack	10-32 Jack	10-32 Jack	10-32 Jack	10-32 Jack
Output Connector	BNC Jack	BNC Jack	BNC Jack	BNC Jack	BNC Jack
Size	3.4 x 0.52 in 86 x 13 mm	3.4 x 0.52 in 86 x 13 mm	3.4 x 0.52 in 86 x 13 mm	3.4 x 0.52 in 86 x 13 mm	3.4 x 0.52 in 86 x 13 mm
Weight	1.15 oz 32.7 gm	1.15 oz 32.7 gm	1.15 oz 32.7 gm	1.15 oz 32.7 gm	1.15 oz 32.7 gm
Additional Versions					
0.5 Hz (-5%), ±2.5 V Output, CE	422E01	422E02	422E03	422E05	422E04
± 2.5 V Output, CE	422E11	422E12	422E13	422E15	422E14
TEDS, ±2.5 V Output, CE	T422E11	T422E12	T422E13	T422E15	T422E14
Miniature Size, TEDS [3]	—	T422E93/A	T422E92/A	—	T422E91/A

Notes

[1] High frequency response may be limited by supply current and output cable length [2] Typical, tested using voltage source and input capacitor equal to the feedback capacitor, to simulate a charge output sensor [3] Units are 1.6 x 0.25 in (length x diameter) (40 x 6.4 mm) with 10-32 jack connectors

In-line ICP® Powered Charge Converters

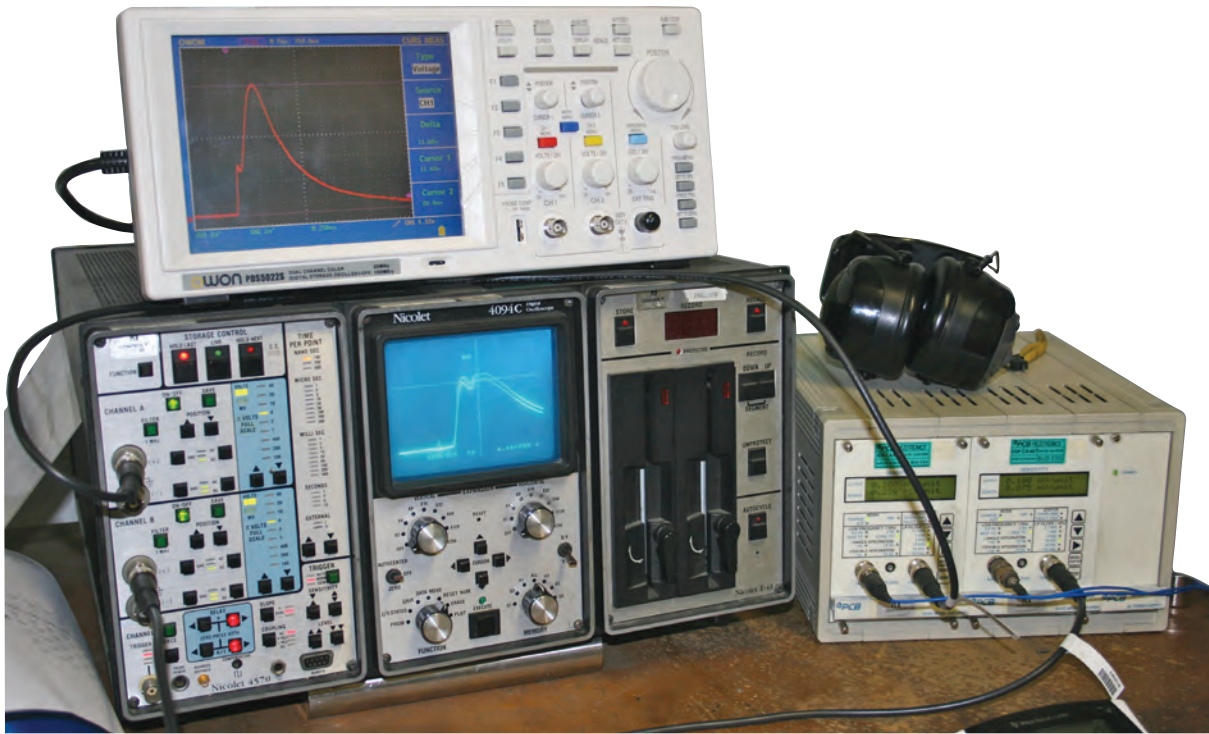

In-Line ICP®-Powered Charge Converters

CE



CE



Model Number	422E36	422E35	422E38	422E66/A	422E65/A
Type	High Temp. Aps [1]	High Temp. Aps [1]	High Temp. Aps [1]	Rad. Hard. Aps [2]	Rad. Hard. Aps [2]
Gain (Charge Conversion Sensitivity)	10 mV/pC ±2%	1 mV/pC ±2%	0.1 mV/pC ±2%	10 mV/pC ±2%	1 mV/pC ±2%
Input Range	±250 pC	±2500 pC	±25,000 pC	±500 pC	±5000 pC
Output Voltage Range	±2.5 V	±2.5 V	±2.5 V	±5.0 V	±5.0 V
Frequency Response (+/-5%) [3]	5 to 100k Hz	5 to 100k Hz	5 to 100k Hz	10 to 90k Hz	5 to 100k Hz
Broadband Electrical Noise [4]	26 µV rms	14 µV rms	14 µV rms	17 µV rms	7 µV rms
Temperature Range	-65 to +250 °F -54 to +121 °C	-65 to +250 °F -54 to +121 °C	-65 to +250 °F -54 to +121 °C	-65 to +250 °F -54 to +121 °C	-65 to +250 °F -54 to +121 °C
Excitation Voltage	18 to 28 VDC	18 to 28 VDC	18 to 28 VDC	18 to 28 VDC	18 to 28 VDC
Constant Current Excitation	2.2 to 20 mA	2.2 to 20 mA	2.2 to 20 mA	2 to 20 mA	2 to 20 mA
Input Connector	10-32 Jack	10-32 Jack	10-32 Jack	10-32 Jack	10-32 Jack
Output Connector	BNC Jack	BNC Jack	BNC Jack	10-32 Jack	10-32 Jack
Size	3.4 x 0.52 in 86 x 13 mm	3.4 x 0.52 in 86 x 13 mm	3.4 x 0.52 in 86 x 13 mm	3 x 0.5 in 76 x 13 mm	3 x 0.5 in 76 x 13 mm
Weight	1.1 oz 31 gm	1.1 oz 31 gm	1.1 oz 31 gm	0.8 oz 23 gm	0.8 oz 23 gm
Additional Version					
TEDS	T422E36	T422E35	—	—	—
Notes	[1] Specifically designed for use with sensors operating in elevated temperature, greater than +400 °F (+204 °C) [2] Specifically designed for use in radiation environments [3] High frequency response may be limited by supply current and output cable length [4] Typical, tested using voltage source and input capacitor equal to the feedback capacitor, to simulate a charge output sensor				

Industrial Charge Amplifiers



Industrial Charge Amplifiers

CE



CE



Model Number	421A11	421A13	421A25
Channels	1	3	1
Number of Measurement Ranges	3	3	13 Fixed, 3 Adjustable
Input Range [1]	±100 to 100,000 pC	±100 to 100,000 pC	±100 to 1,000,000 pC
Sensitivity [1]	5.00 to 0.05 mV/pC	5.00 to 0.05 mV/pC	100 to 0.01 mV/pC
Output Voltage	±5 V	±5 V	±10 V
Low Frequency Response	-0 Hz	-0 Hz	-0 Hz
High Frequency Response (-5%)	4 to 12 kHz [1]	4 to 12 kHz [1]	2 to 20 kHz [1] [4]
Broadband Electrical Noise	11 µV rms [2]	11 µV rms [2]	<20 mVpp [5]
Drift	0.03 pC/s	0.03 pC/s	0.03 pC/s [6]
Temperature Range	+32 to +140 °F 0 to +60 °C	+32 to +140 °F 0 to +60 °C	+23 to +140 °F -5 to +60 °C
Power Required	15 to 30 VDC	15 to 30 VDC	15 to 35 VDC
Current Draw (Maximum)	19 mA	19 mA	70 mA
Input Connector	BNC Jack	BNC Jacks	BNC Jack
Output Connector	Screw Terminal [3]	Screw Terminal [3]	DB25 Male [7]
Size	4.89 x 2.52 x 1.50 in 124.2 x 64 x 38.1 mm	6.95 x 2.52 x 1.50 in 176.5 x 64 x 38.1 mm	3.9 x 3.1 x 1.35 in 98 x 79 x 34.4 mm
Weight	14.6 oz 415 gm	21.1 oz 598.7 gm	9.6 oz 272.2 gm
Supplied Accessories			
Ferrite Beads	(2) 100-2973-30	(4) 100-2973-30	—
Additional Versions			
2-Channel	421A12	421A12	—
200,000 pC Input	421A111	421A113	—

Notes

[1] Dependent on input range selected [2] Noise measurements performed at 10,000 pC to 100,000 pC range [3] Supplied with 10-ft multi-conductor cable and PG-9 cord grip [4] - 3dB [5] Measured 0.1 Hz to 100 kHz; <30 mVpp in 100 pC range [6] At room temperature. Scope: charge input open and screened, charge amplifier connected to operating voltage for minimum 30 minutes, in "operate" mode, lid tightly closed [7] Connector also used for setup control and power

Differential Charge Converters



Differential Charge Converters

			
			CE
Model Number	422M182	422M183	495B10-02-10
Type [1]	Differential Appls.	Differential Appls.	Differential Appls.
Gain	4 mV/pC ±5%	6 mV/pC ±5%	2 mV/pC
Input Range	±1250 pC	±833 pC	±1250 pC
Output Voltage Range	±5.0 V	±5.0 V	±2.5 V
Low Frequency Response (±5%)	2 Hz	2 Hz	10 Hz [4]
High Frequency Response (±5%)	55k Hz [2]	55k Hz [2]	10k Hz [5]
Broadband Electrical Noise	28 µV rms [3]	28 µV rms [3]	36 µV rms
Temperature Range	-60 to +185 °F -51 to +85 °C	-60 to +185 °F -51 to +85 °C	-13 to +185 °F -25 to +85 °C
Power Required	ICP® Power	ICP® Power	10 to 32 VDC/ 17 mA
ICP® Excitation Voltage	22 to 28 VDC	22 to 28 VDC	—
ICP® Constant Current Excitation	2.2 to 20 mA	2.2 to 20 mA	—
2-pin Input Connector	2-pin 5/8-24 UNF-2A	2-pin 5/8-24 UNF-2A	PC02A-8-2S
Output Connectors	BNC Jack	BNC Jack	PT02H-10-6P
Size	4.58 x 1.25 x 1.25 in 116.21 x 31.75 x 31.75 mm	4.58 x 1.25 x 1.25 in 116.4 x 31.75 x 31.75 mm	5.5 x 1.73 x 1.21 in 139.7 x 43.8 x 30.8 mm
Weight	3.5 oz 109 gm	3.5 oz 109 gm	7.2 oz 204 gm
Notes			

[1] Specifically designed for use with differential output sensors [2] High frequency response may be limited by supply current and output cable length [3] Tested using voltage source and input capacitor equal to the feedback capacitor, to simulate a charge output sensor [4] Acceleration output: -120 dB/decade [5] Both acceleration and velocity outputs have -40 dB/decade response past upper frequency limit

In-line Voltage Follower Amplifiers

Impedance Converters and In-line Voltage Follower Amplifiers Series 402



Series 402A In-line voltage follower amplifiers, similar to the Series 422E charge converters, serve to convert charge output sensor signals to low-impedance voltage signals. They are recommended for applications requiring high frequency response up to 1 MHz, and for applications where sensor output (pC/unit) exceeds the maximum input range (pC) allowed in the Series 422E.

The voltage sensitivity, V , of a system including a charge output sensor, low-noise cable and voltage follower amplifier can be determined mathematically by the equation $V=Q/C$ where Q is the charge sensitivity of the sensor in Coulombs and C is the total system capacitance in Farads. The total system capacitance is the result of the sum of the capacitance of the sensor, the capacitance of the interconnect cable, and the input capacitance of the voltage amplifier. Choose a voltage follower amplifier with an input capacitance that provides the sensitivity desired, while keeping the total output voltage (range x sensitivity) within the ± 10 volt limit. Voltage follower amplifiers do not invert the polarity of the measurement signal.

In-line Voltage Follower Amplifiers



Model Number	402A	402A02	402A03
Voltage gain ($\pm 2\%$)	0.98	0.98	0.98
Output Range	± 10 V	± 10 V	± 10 V
Input Capacitance	< 8.0 pF	$100 \pm 10\%$ pF	$1000 \pm 10\%$ pF
Discharge Time Constant	1.0 second	10 second	100 second
Frequency Response ($\pm 5\%$) [1]	0.5 to 1M Hz	0.05 to 1M Hz	0.005 to 1M Hz
Broadband Noise	43 μ V rms	43 μ V rms	43 μ V rms
Output Bias	8 to 13 V	8 to 13 V	8 to 13 V
Temperature Range	-65 to +250 °F -54 to +121 °C	-65 to +250 °F -54 to +121 °C	-65 to +250 °F -54 to +121 °C
Power Required	18 to 28 VDC	18 to 28 VDC	18 to 28 VDC
Constant Current Required	2 to 20 mA	2 to 20 mA	2 to 20 mA
Input Connector	10-32 jack	10-32 jack	10-32 jack
Output Connector	10-32 jack	10-32 jack	10-32 jack
Size (Length x Diameter)	1.17 x 0.25 in 30 x 6 mm	1.17 x 0.25 in 30 x 6 mm	1.17 x 0.25 in 30 x 6 mm

Notes

[1] High frequency achieved at 20 mA excitation

Additional Electronics

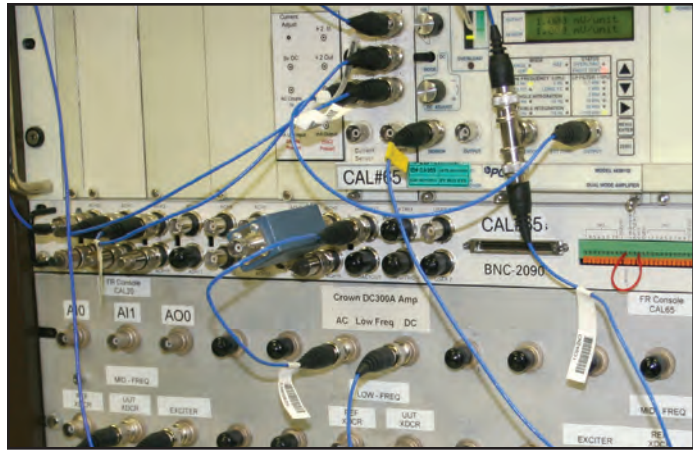

In-line TEDS Memory Modules



Model 070A70



Model 070A71

Models 070A70 and 070A71 are TEDS memory modules, which can be added in-line with standard ICP® sensors, to construct a sensor system with TEDS functionality.

Both units are identical except for their electrical connectors. Model 070A70 features a BNC jack input connector and a BNC plug output connector, whereas Model 070A71 features a 10-32 coaxial jack input and output connector.

ICP® sensor excitation is passed through the units to the sensor. Under reverse bias, the memory circuitry is activated for read and write capability per IEEE P1451.4.

TEDS functionally permits data storage within a non-volatile EEPROM memory circuit to store information such as model number, serial number, sensitivity, location, and orientation. The standard TEDS protocol complies with IEEE P1451.4, which facilitates automated bookkeeping and measurement system setup to speed testing and reduce errors.



ICP® Sensor Simulator

Model 492B ICP® sensor simulator installs in place of an ICP® sensor and serves to verify signal conditioning settings, cable integrity, and tune long lines for optimum system performance. By use of an internal oscillator, the unit delivers a 100 Hz sine or square wave at a selectable peak-to-peak voltage. External test signals from a function generator may also be inserted. This portable unit is battery operated.

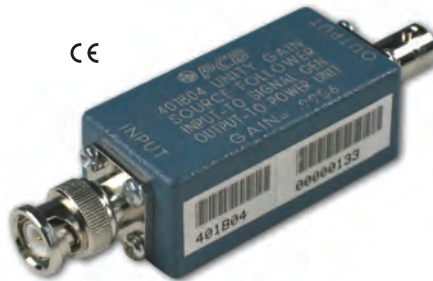

ICP® Sensor Simulator

Model 401B04 ICP® sensor simulator installs in place of an ICP® sensor and accepts test signals from a voltage function generator. The unit serves to verify signal conditioning settings, cable integrity, and tune long lines for optimum system performance. This unit requires power from an ICP® sensor signal conditioner.



Step Function Generator

Model 492B03 generates a rapid charge or voltage step function from zero to a selected peak value between either 0 and 100,000 pC or 0 and 10 volts DC. The unit is useful for setting trigger points in recording equipment and verifying charge amplifier and data acquisition equipment setup. This unit is battery powered and portable.

Cable Assemblies & Connector Adaptors



Highlights

- Coaxial Cable Assemblies
- 4-Connector Cable Assemblies
- Custom Cable Assemblies
- Cable Connectors
- Coaxial Custom Cable Assemblies
- Multi-conductor Custom Cable Assemblies
- Multi-conductor Cables
- Patch Panels
- Connector Adaptors

Coaxial Cable Assemblies

Coaxial Cable Assemblies

Base Model	Construct cable assembly model by combining base model with desired length, e.g., 002C10.								
	1 ft (0.3 m)	3 ft (0.9 m)	5 ft (1.5 m)	10 ft (3.0 m)	20 ft (6.1 m)	30 ft (9.1 m)			50 ft (15.2 m)
030A		03	05	10	20	30	50	PTFE, Low Noise, Miniature	3-56 Plug to 10-32 Plug
030C			05	10	20	30	50	PTFE, Low Noise, Miniature	3-56 Plug to BNC Plug
018G		03	05	10	20	30		PVC, Miniature	5-44 Plug to 10-32 Plug
003G		03	05	10	20	30		TFE, Low Noise	5-44 Plug to 10-32 Plug
002P		03	05	10	20	30		FEP	5-44 Plug to BNC Plug
003P		03	05	10	20	30		TFE, Low Noise	5-44 Plug to BNC Plug
018C		03	05	10	20	30		PVC, Miniature	5-44 Plug to BNC Plug
030B			05	10	20			PTFE, Low Noise, Miniature	M3 Plug to 10-32 Plug
003R			05	10	20			TFE, Low Noise	M3 Plug to 10-32 Plug
002A		03	05	10	20	30	50	FEP	10-32 Plug to 10-32 Plug
003A	01	03	05	10	20	30	50	TFE, Low Noise	10-32 Plug to 10-32 Plug
023A				10				Hardline	10-32 Plug to 10-32 Jack
002C		03	05	10	20	30	50	FEP	10-32 Plug to BNC Plug
003C		03	05	10	20	30	50	TFE, Low Noise	10-32 Plug to BNC Plug
002B	01	03						FEP	10-32 Plug to BNC Jack
003B	01	03						TFE, Low Noise	10-32 Plug to BNC Jack
003U				10				TFE, Low Noise	SMB Female Plug to SMB Female Plug
003V				10				TFE, Low Noise	SMB Female Plug to BNC Plug
002T		03	05	10	20	30		FEP	BNC Plug to BNC Plug
003D		03		10	20			TFE, Low Noise	BNC Plug to BNC Plug
012A		03	05	10	20	30	50	PVC, RG58/U	BNC Plug to BNC Plug
012E				10	20		50	PVC, RG58/U	2-Socket Env. Sealed to BNC Plug
012R				10	20		50	PVC, RG58/U	2-Socket MIL to BNC Plug



Coaxial Cable Specifications

Model	002	003	012	018	030
Cable Style	General Purpose	Low Noise	General Purpose	General Purpose	Low Noise
Temperature Range	-130 to +400 °F -90 to +204 °C	-320 to +500 °F -196 to +260 °C	-40 to +176 °F -40 to +80 °C	-22 to +221 °F -30 to +105 °C	-130 to +500 °F -90 to +260 °C
Impedance	50 Ohm	50 Ohm	52 Ohm	32 Ohm	50 Ohm
Capacitance	29 pF/ft 95 pF/m	30 pF/ft 98 pF/m	29 pF/ft 95 pF/m	55 pF/ft 180 pF/m	30 pF/ft 98 pF/m
Cable Jacket Material	FEP	TFE	PVC	PVC	PTFE
Cable Jacket Diameter	0.075 in 1.9 mm	0.079 in 2.01 mm	0.193 in 4.9 mm	0.054 in 1.37 mm	0.042 in 1.09 mm

Other Coaxial Cable Specifications

Model	005	006	023	038	098
Cable Style	Ruggedized	Low Noise Ruggedized	Hardline	Low Noise	Low Noise Flexible
Temperature Range	-67 to +275 °F -55 to +135 °C	-67 to +275 °F -55 to +135 °C	-300 to +1200 °F -184 to +650 °C	-58 to +250 °F -50 to +121 °C	-130 to +500 °F -90 to +260 °C
Impedance	50 Ohm	50 Ohm	—	50 Ohm	50 Ohm
Capacitance	29 pF/ft 95 pF/m	30 pF/ft 98 pF/m	100 pF/ft 328 pF/m	30 pF/ft 100 pF/m	35 pF/ft 115 pF/m
Cable Jacket Material	Polyolefin over Steel Braid	Polyolefin over Steel Braid	Stainless Steel	Polyurethane	TFE
Cable Jacket Diameter	0.200 in 5.08 mm	0.200 in 5.08 mm	0.059 in 1.5 mm	0.119 in 3.02 mm	0.079 in 2.01 mm

4-Conductor Cable Assemblies

4-Conductor Cable Assemblies								
Base Model	5 ft (1.5 m)	10 ft (3.0 m)	15 ft (4.6 m)	20 ft (6.1 m)	25 ft (7.6 m)	30 ft (9.1 m)	50 ft (15.2 m)	Construct cable assembly model by combining base model with desired length, e.g., 034G20.
034H	05	10		20		30	50	FEP, Lightweight Mini 4-Socket Plug to (3) 10-32 Plugs
034K	05	10		20		30	50	FEP, Lightweight Mini 4-Socket Plug to (3) BNC Plugs
019B	05	10	15	20		30		Silicone, Flexible, Lightweight Mini 4-Socket Plug to (3) BNC Plugs
010P	05	10		20		30	50	FEP, General Purpose 4-Socket Plug to Pigtailed
034A	05	10		20		30	50	FEP, Lightweight 4-Socket Plug to Pigtailed
010D	05	10	15	20	25	30		FEP, General Purpose 4-Socket Plug to 4-Socket Plug
034D	05	10		20		30	50	FEP, Lightweight 4-Socket Plug to 4-Socket Plug
078D	05	10		20		30	50	Polyurethane, Flexible 4-Socket Plug to 4-Socket Plug
010F	05	10	15	20	25	30	50	FEP, General Purpose 4-Socket Plug to (3) 10-32 Plugs
034F	05	10		20		30	50	FEP, Lightweight 4-Socket Plug to (3) 10-32 Plugs
078F		10	15		25			Polyurethane, Flexible 4-Socket Plug to (3) 10-32 Plugs
010G	05	10	15	20	25	30	50	FEP, General Purpose 4-Socket Plug to (3) BNC Plugs
034G	05	10	15	20	25	30	50	FEP, Lightweight 4-Socket Plug to (3) BNC Plugs
036G	05	10	15	20	25	30		Silicone, Flexible 4-Socket Plug to (3) BNC Plugs
078G	05	10	15	20	25	30	50	Polyurethane, Flexible 4-Socket Plug to (3) BNC Plugs

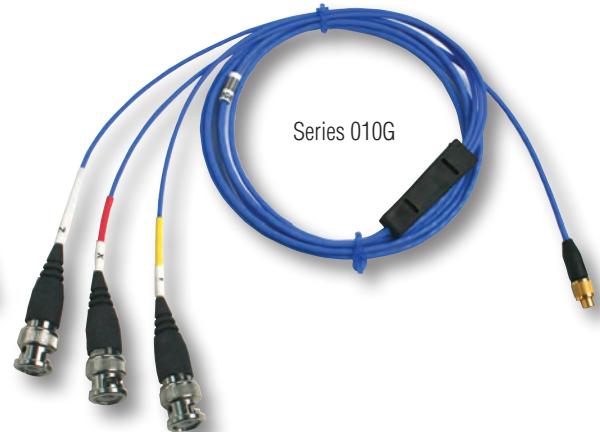
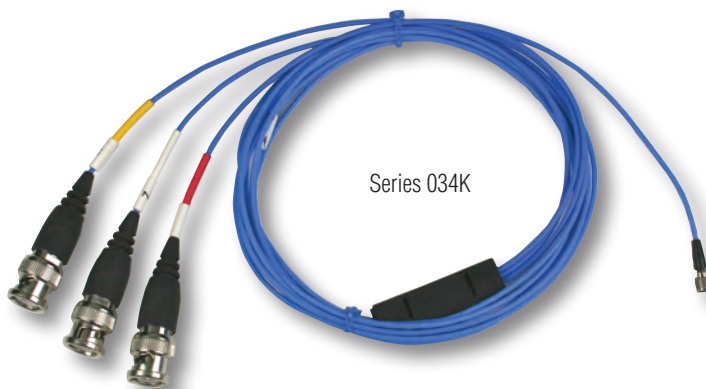

4-Conductor Cable Specifications					
Model	010	034	019	036	078
Cable Style	General Purpose	Low Noise	Flexible Lightweight	Flexible	Flexible
Temperature Range	-130 to +392 °F -90 to +200 °C	-130 to +392 °F -90 to +200 °C	-76 to +500 °F -60 to +260 °C	-76 to +392 °F -60 to +200 °C	-58 to +185 °F -50 to +85 °C
Capacitance	16 pF/ft 52.4 pF/m	14 pF/ft 46 pF/m	15 pF/ft 49.2 pF/m	15 pF/ft 48 pF/m	25 pF/ft 81 pF/m
Cable Jacket Material	FEP	FEP	Silicone	Silicone	Polyurethane
Cable Jacket (Diameter)	0.1 in 2.54 mm	0.077 in 1.96 mm	0.070 in 1.77 mm	0.104 in 2.64 mm	0.119 in 3.02 mm

Custom Cable Assemblies

How to Configure Custom Cable Models:

1. Choose the cable length format desired, either English (ft) or Metric (m) unit lengths.
2. Choose the desired raw cable type.
3. Choose desired sensor connector type.
4. Determine the cable length required in English (ft) or Metric (m) unit lengths.
5. Choose desired termination connector type.

Example:

Model 003AK025AC defines a 25 ft, low-noise cable with right angle 10-32 plug sensor connector, BNC plug termination connector.

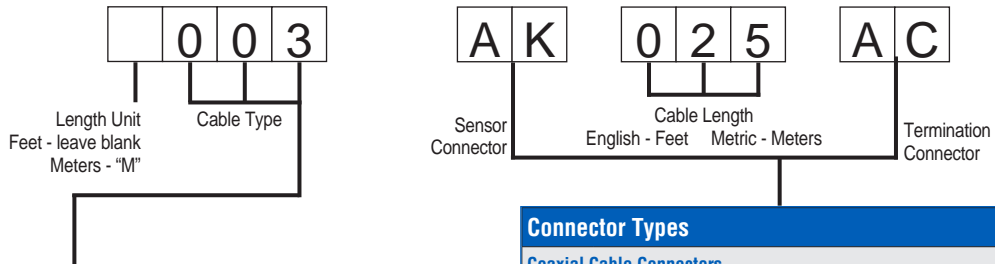

Raw Cable Type				
Coaxial Cables			Diameter	Max. Temp.
002	General Purpose, White FEP Jacket	CE	0.075 in 1.9 mm	400°F 204°C
003	Low Noise, Blue TFE Jacket	CE	0.079 in 2.0 mm	500°F 260°C
005	Ruggedized 002 Type, General Purpose	CE	0.2 in 5.08 mm	275°F 135°C
006	Ruggedized 003 Type, Low Noise	CE	0.2 in 5.08 mm	275°F 135°C
012	RG-58/U, Black Vinyl Jacket	CE	0.193 in 4.90 mm	176°F 80°C
018	Lightweight, Black PVC Jacket		0.054 in 1.37 mm	221°F 105°C
030	Low Noise, Mini, PTFE Jacket	CE	0.043 in 1.1 mm	500°F 260°C
038	Low Noise, Blue Polyurethane Jacket	CE	0.119 in 3.02 mm	250°F 121°C
098	Flexible, Low Noise, Green TFE Jacket	CE	0.079 in 2.06 mm	500°F 260°C
Twisted/Shielded Pair Cable				
024	General Purpose, Black Polyurethane Jacket	CE	0.250 in 6.35 mm	250°F 121°C
032	Lightweight, FEP Jacket		0.085 in 2.16 mm	392°F 200°C
045	High Temperature, Red PFA Jacket	CE	0.204 in 5.18 mm	250°F 121°C
053	High Temperature, Red FEP Jacket	CE	0.157 in 3.99 mm	392°F 200°C
Shielded 4-Conductor Cable				
010	General Purpose, FEP Jacket	CE	0.1 in 2.54 mm	392°F 200°C
034	Lightweight, FEP Jacket	CE	0.077 in 1.96 mm	392°F 200°C
019	Lightweight, Blue Silicon Jacket	CE	0.068 in 1.73 mm	500°F 260°C
036	General Purpose, Blue Silicon Jacket	CE	0.104 in 2.64 mm	392°F 200°C
078	General Purpose, Blue Polyurethane Jacket	CE	0.119 in 3.02 mm	185°F 85°C
Hardline Cable				
013	Hardline, 2-conductor, Inconel Jacket		0.125 in 3.20 mm	1200 °F 650 °C
023	Hardline, Coaxial, 304L Stainless Steel Jacket		0.059 in 1.5 mm	1200 °F 650 °C
Miscellaneous Cable				
031	Red/White Twisted Pair, PTFE Jacket		0.03 in* 0.8 mm*	392°F 200°C
037	10-cond. Shielded, Black Poly Jacket		0.024 in 0.61 mm	250°F 121°C

* diameter of each conductor
 The combination of cables and connectors listed are only recommended configurations; other configurations may be available. Consult PCB® before ordering.
 CE designates that cable maintains CE conformance

Connector Types	
Coaxial Cable Connectors	
EB	10-32 Plug
EJ	10-32 Plug (Spring Loaded)
AH	10-32 Plug (Hex)
AK	10-32 Plug (Right-Angle)
AW	10-32 Plug (Solder Adaptor)
FZ	10-32 Plug (for 023 Hardline Cabling)
AL	10-32 Jack
GA	10-32 Jack (for 023 Hardline Cabling)
AG	5-44 Plug
AF	5-44 Plug (Right-Angle)
EK	3-56 Plug
EP	M3 Plug
AC	BNC Plug
AB	BNC Jack
FW	SMB Plug
FX	SMB Jack
Multi-Lead Connectors (For Triaxial Sensors)	
AY	4-Socket Plug
CA	4-Pin Jack
EH	4-Socket Miniature Plug
HJ	4-Pin Miniature Jack
EN	9-Socket Plug
GJ	9-Pin Plug
JY	Splice Assembly to (3) EB Connectors
LA	Splice Assembly to (3) EJ Connectors
JZ	Splice Assembly to (3) AL Connectors
JW	Splice Assembly to (3) AC Connectors
JX	Splice Assembly to (3) AB Connectors
JS	Splice Assembly to (3) AY Connectors
Miscellaneous Connectors	
AE	2-Socket Plug MS3106 5/8-24 thd (with Environmental Boot)
AM	2-Socket Plug MS3106 5/8-24 thd
AP	2-Socket Plug MS3106 5/8-24 thd (with Strain Relief)
BP	2-Socket Plug MS3106 5/8-24 thd (High Temperature)
ET	2-Socket Plug MIL 7/16-27 thd (High Temperature)
GN	2-Socket Plug MIL 7/16-27 thd (for 013 Hardline Cabling)
GP	2-Pin Jack MIL 7/16-27 thd (for 013 Hardline Cabling)
LN	8-Pin Mini DIN (for 4-Wire Bridge)
BZ	Blunt Cut
DZ	Pigtail (Leads Stripped and Tinned for 3711/3713 Series)
JJ	Pigtail (Leads Stripped and Tinned for 3741 Series)
AD	Pigtail (Leads Stripped and Tinned for all Others)



Cable Connectors

AB BNC Jack

Max Temp 329 °F (165 °C)



AC BNC Plug

Max Temp 329 °F (165 °C)



AD Pigtail (leads stripped and tinned)

Max Temp 490 °F (254 °C)*



AE 2-Socket MS3106 Plug (with environmental boot)

Max Temp 325 °F (163 °C)



AF 5-44 Coaxial Plug (right angle)

Max Temp 392 °F (200 °C)



AG 5-44 Coaxial Plug (straight)

Max Temp 500 °F (260 °C)



AH 10-32 Coaxial Plug (straight, with wire locking hex)

Max Temp 450 °F (232 °C)



AK 10-32 Coaxial Plug (right angle)

Max Temp 329 °F (165 °C)



AL 10-32 Coaxial Jack (straight)

Max Temp 500 °F (260 °C)



AP 2-Socket MS3106 Plug (with strain relief)

Max Temp 257 °F (125 °C)



AW 10-32 Coaxial Plug / Solder Adaptor (user repairable)

Max Temp 500 °F (260 °C)*



AY 4-Socket Plug, 1/4-28 Thread (for triaxial sensors)

Max Temp 325 °F (163 °C)



CA 4-Pin Jack, 1/4-28 Thread (for triaxial sensors)

Max Temp 325 °F (163 °C)



EB 10-32 Coaxial Plug (straight)

Max Temp 500 °F (260 °C)



EH 4-Socket Mini Plug, 8-36 Thread (for triaxial sensors)

Max Temp 356 °F (180 °C)



EJ 10-32 Coaxial Plug (straight, o-ring seal, spring loaded)

Max Temp 500 °F (260 °C)



EK 3-56 Coaxial Plug

Max Temp 500 °F (260 °C)



EN 9-Socket Plug (for triaxial capacitive accelerometers)

Max Temp 275 °F (135 °C)



EP M3 Coaxial Plug

Max Temp 500 °F (260 °C)



ET 2-Socket Plug, 7/16-27 Thread

Max Temp 500 °F (260 °C)



FZ 10-32 Coaxial Plug (for hardline cable)

Max Temp 900 °F (482 °C)



GA 10-32 Coaxial Jack (for hardline cable)

Max Temp 550 °F (288 °C)



GN 2-Socket Plug, 7/16-27 Thread (high temperature)

Max Temp 900 °F (482 °C)



GP 2-Pin Jack, 7/16-27 Thread (high temperature)

Max Temp 900 °F (482 °C)



*Max Temp may be less depending upon cable application.

Custom Cable Assemblies

PCB® offers many standard cable assemblies, however, in the event that a standard cable assembly will not fulfill the requirements of the application, the ability to configure a custom cable assembly is offered. Start by ensuring compatibility of the connector type with the cable type desired from the chart below, and then configure the custom cable model number from the steps on the previous page.

Cable - Connector Compatibility Matrix

The following table provides compatibility information for cables and cable connectors. A “✓” denotes compatibility of the connector type shown in the rows going down the table with the cable type of the intersecting column going across the table.

Coaxial Custom Cable Assemblies

Cable	002	003	005	006	012	013	018	023	024	030	031	032	038	045	053	098
Connector																
AB	✓	✓	✓	✓	✓		✓		✓	✓	✓	✓	✓	✓	✓	✓
AC	✓	✓	✓	✓	✓		✓		✓	✓	✓	✓	✓	✓	✓	✓
AD	✓	✓	✓	✓	✓		✓		✓	✓	✓	✓	✓	✓	✓	✓
AE		✓			✓				✓						✓	
AF	✓	✓	✓	✓			✓			✓						
AG	✓	✓	✓	✓			✓			✓	✓	✓	✓			✓
AH	✓	✓	✓	✓			✓			✓		✓				
AK	✓	✓	✓	✓			✓			✓		✓	✓			✓
AL	✓	✓	✓	✓			✓			✓	✓	✓				✓
AP	✓	✓	✓	✓	✓				✓			✓	✓	✓	✓	
AW											✓					
BP	✓	✓		✓									✓	✓	✓	✓
BZ	✓	✓	✓	✓	✓		✓		✓	✓	✓	✓	✓	✓	✓	✓
EB	✓	✓	✓	✓			✓			✓	✓	✓	✓	✓	✓	✓
EJ	✓	✓	✓	✓			✓			✓		✓	✓			✓
EK										✓						
EP	✓	✓	✓	✓			✓			✓						
ET														✓	✓	
FW	✓	✓	✓	✓			✓			✓						
FX	✓	✓														
FZ									✓							
GA									✓							
GN						✓										
GP						✓										

Multi-conductor Custom Cable Assemblies

Cable	010	019	034	036	037	078
Connector						
AD	✓	✓	✓	✓	✓	✓
AY	✓	✓	✓	✓		✓
BZ	✓	✓	✓	✓	✓	✓
CA	✓	✓	✓	✓		✓
DZ	✓		✓		✓	✓
EH		✓	✓			
EN					✓	
GJ					✓	
HJ			✓			
JJ	✓					
JS					✓	
JW	✓	✓	✓	✓		✓
JX	✓	✓	✓	✓		✓
JY	✓	✓	✓	✓		✓
JZ	✓	✓	✓	✓		✓
LA	✓	✓	✓	✓		✓

Multi-conductor Cables

Multi-conductor cables minimize tangles and reduce overall cable costs. They also offer numerous cable/termination variations to suit a particular transmission requirement, as well as the ability to consolidate several cables into one.



Model 009F "xx"
Flat ribbon cable
DB50 female to DB50 male
Specify "xx" length in feet



Model 009H "xx"
Shielded ribbon cable
DB50 female to DB50 male
Specify "xx" length in feet



Model 009L05
Multi-conductor cable
VXI to 4 BNC plugs
5 ft (1.5 m) length



Model 009S05
Multi-conductor cable
VXI to VXI
5 ft (1.5 m) length



Model 009B "xx"
Ruggedized
Shielded multi-conductor cable
DB50 female to DB50 male
Specify "xx" length in feet



Model 009A "xx"
Ruggedized
Multi-conductor cable
DB50 female to 16 BNC Plugs
Specify "xx" length in feet

Patch Panels

Input patch panels serve as a central collection point for individual sensor cables installed in multi-channel measurement arrays. The sensor signal paths are then consolidated and transmission to readout or data acquisition equipment is accomplished by a single, multi-conductor cable.

Output patch panels connect via multi-conductor cables to the output connectors on high density rack or modular signal conditioners. The sensor signal paths are then expanded to individual BNC's for each channel for subsequent connection to data acquisition equipment.



Model 070C21
16-channel input patch panel
16 IDC pin inputs
DB50 male output



Model 070C29
16-channel input patch panel
16 BNC jack and
16 IDC pin inputs
DB50 male output

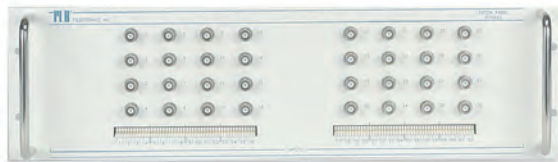

Model 070A33
32-channel input patch panel
32 BNC jack and 32 IDC pin inputs
2 DB50 male outputs
Rack mount



Model 070A34
32-channel output patch panel
2 DB37 male inputs
4 DB37 female servo inputs
4 DB50 male HP outputs
32 BNC jack outputs
Rack mount

Connector Adaptors



Scope Input Adaptor

10-32 coaxial jack to BNC plug. For adapting BNC connectors for use with 10-32 coaxial plugs.



Connector Adaptor

10-32 coaxial plug to BNC jack. Converts 10-32 connectors for use with BNC plugs. Do not use on sensor connectors.



10-32 Coaxial Coupler

10-32 coaxial jack to 10-32 coaxial jack. Joins two cables terminating in 10-32 coaxial plugs.

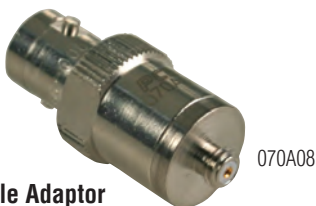

Cable Adaptor

10-32 coaxial jack to BNC jack. Joins cables terminating in a BNC plug and a 10-32 coaxial plug.

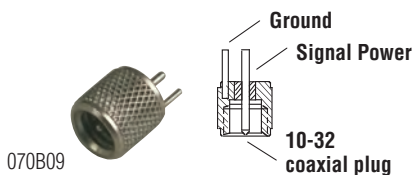

Solder Connector Adaptor

10-32 coaxial plug to solder terminals. Excellent for high-shock applications. User-repairable.



BNC T Connector

BNC plug to two BNC jacks. Used as a cable splitter.



BNC Coupler

BNC jack to BNC jack. Joins two cables terminating in BNC plugs.



Feed-thru Adaptor

10-32 coaxial jack to BNC jack. Bulkhead connects BNC plug to 10-32 coaxial jack.



10-32 Hermetic Feed-thru

10-32 coaxial jack to 10-32 coaxial jack.



10-32 Coaxial Right Angle Adaptor

10-32 coaxial jack to 10-32 coaxial plug. For use in confined locations. For ICP® sensors only.

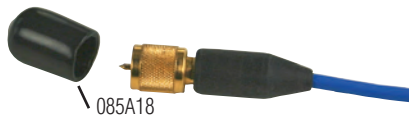

Plastic Protective Cap

Provides strain relief for solder connector adaptors, as well as protects 10-32 cable ends.



10-32 Coaxial Shorting Cap

Used to short charge output sensor connectors during storage and transportation.



10-32 Coaxial Plug

Microdot connector, screw-on type.



Connector Tool

Used to install 076A05 screw-on type microdot connector.



Coaxial Connector

10-32 crimp-on style coaxial connector. Requires tools contained in Model 076C31 kit.



Crimping tool

Pin tool

10-32 Coaxial Crimp-on Connector Kit

Includes 1 pin insertion tool, 1 sleeve-crimping tool, and 20 Model "EB" connectors with cable strain reliefs. (Wire stripper and soldering iron not included).

Calibration Services

For Shock, Vibration, Acoustic, Pressure, Force, Torque Sensors, and Load Cells

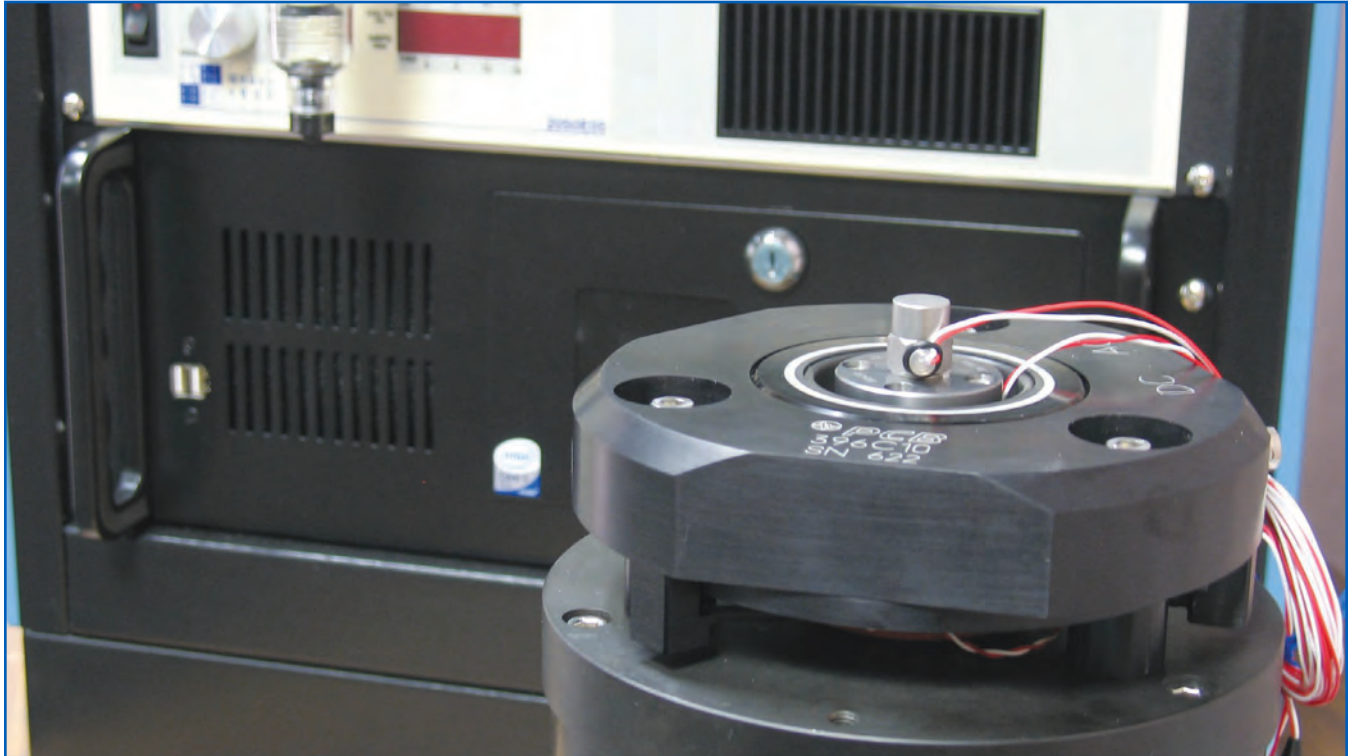

~ Calibration Certificate ~
Per ISO 10083-21

Model Number: 353B33
Serial Number: Sample
Description: ICP® Accelerometer **Method:** Back-to-Back Comparison (AT401-3)
Manufacturer: PCB

Calibration Data

Sensitivity @ 100.0 Hz	101.7 mV/g	Output Bias	9.6 VDC
	(10.37 mV/m/s²)	Transverse Sensitivity	0.2 %
Discharge Time Constant	0.5 seconds	Resonant Frequency	25.9 kHz

Sensitivity Plot

Temperature: 73 °F (23 °C) Relative Humidity: 56 %

Data Points			
Frequency (Hz)	Dev. (%)	Frequency (Hz)	Dev. (%)
10.0	-0.2	300.0	0.1
15.0	0.0	500.0	0.1
30.0	-0.1	1000.0	0.2
50.0	0.0	3000.0	1.0
REF. FREQ.	0.0	4000.0	4.0

Condition of Unit

As Found: n/a
As Left: New Unit, In Tolerance

Notes

- Calibration is NIST Traceable thru Project 822/277342 and PTB Traceable thru Project 1254.
- This certificate shall not be reproduced, except in full, without written approval from PCB Piezotronics, Inc.
- Calibration is performed in compliance with ISO 9001, ISO 10012-1, ANSI/NCSL Z540-1-1994 and ISO 17025.
- See Manufacturer's Specification Sheet for a detailed listing of performance specifications.
- Measurement uncertainty (95% confidence level with coverage factor of 2) for frequency ranges tested during calibration are as follows: 5-9 Hz; +/- 2.0%, 10-99 Hz; +/- 1.5%, 100-1999 Hz; +/- 1.0%, 2-10 kHz; +/- 2.5%.

Technician: Joe Calibrator Date: 08/06/10

PCB PIEZOTRONICS
VIBRATION DIVISION
3425 Walden Avenue Depew, NY 14043
TEL: 888-684-0013 FAX: 716-685-3886 www.pcb.com

Typical Accelerometer Calibration Certificate

Highlights

- Traceable to NIST and PTB laboratories
- Dynamic and static calibration capabilities
- Sensor performance evaluation testing
- ISO 9001:2015 QMS certified by DQS, Inc.
- ISO 17025 accredited by A2LA for most services
- The industry's most comprehensive capabilities

PCB® Piezotronics provides some of the most comprehensive calibration and testing services in the industry. Considerable investment in equipment, coupled with conformance to industry and ISO 9001:2015 QMS certified by DQS, Inc. standards, ensures that PCB® sensors will perform in accordance with their specifications. Calibration services are also available for other manufacturer's sensors.

A complete sensor calibration encompasses sensitivity, linearity, and, where applicable, its frequency response determination. In addition, evaluation of a sensor's performance for the various environments in which it will operate is desirable. PCB® provides all of these services.

Calibration Services

Shock and Vibration Sensor Calibration Services

Primary Reference

- High degree of accuracy
- Laser interferometer measurement
- A2LA accredited to ISO 17025
- 5 Hz to 15 kHz frequency range
- Uncertainties: 0.2% at 100 Hz, <1.5% to 15 kHz



Back-to-Back Secondary Reference

Accelerometer under test is mounted to a reference standard sensor atop a shaker.

Back-to-Back Secondary Reference

- Quartz reference comparative accelerometer
- Electrodynamic and air-bearing shakers
- NIST and PTB traceability for multiple frequency data points
- A2LA accredited to ISO 17025
- 5 Hz to 15 kHz frequency range
- Uncertainties: 1% at 100 Hz, <2.5% to 10 kHz, <7% to 15 kHz
- Customized software for quick transfer function determination over a sensor's usable frequency range



Laser Interferometer Measurement

Primary calibration of vibration transducers by laser interferometry are made with a precision level that is directly traceable to the wavelength of the laser light.



Low-frequency Accelerometer Calibrator

With a 6-inch (152 mm) stroke, this "long stroke" shaker provides enough displacement for low-frequency calibrations to 0.5 Hz.

Gravimetric Method (low frequency)

- Mass and gravity references
- Low distortion, long stroke, air-bearing shaker
- 0.5 Hz to 10 Hz frequency range
- Uncertainty of <2.5%

Calibration Services

Shock and Vibration Sensor Calibration Services



Hopkinson Bar - Model 925A01

High amplitude shock sensors undergo linearity and zero shift tests with exposures to impact shocks of more than 100,000 g

Hopkinson Bar Method (high-amplitude shock)

- Wave propagation velocity reference
- Pneumatically propelled projectile impactor
- >100,000 g (981,000 m/s²) amplitude range
- Tests amplitude response, linearity, and zero shift behavior

Impact Hammer Calibration Services

Pendulous Mass Method

- Quartz reference accelerometer
- Dynamic technique for improved accuracy
- Calibrates force hammers and impactors with head mass from 0.1 oz (2.9 gm) to >12 lb (5.44 kg)

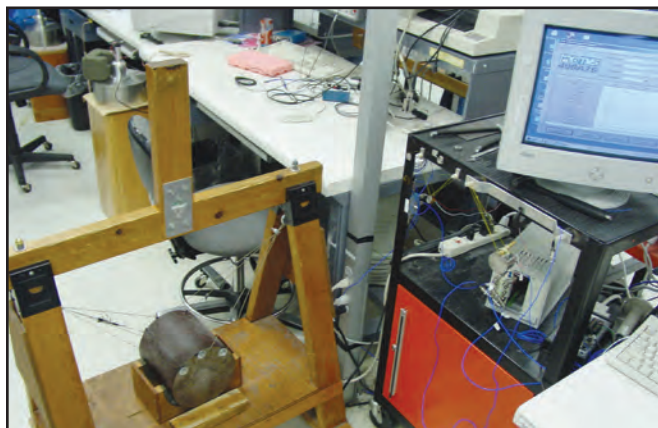

Impact Hammer Calibration

Pendulous mass and reference accelerometer provide dynamic calibration with reference to Newton's law, $F = ma$.

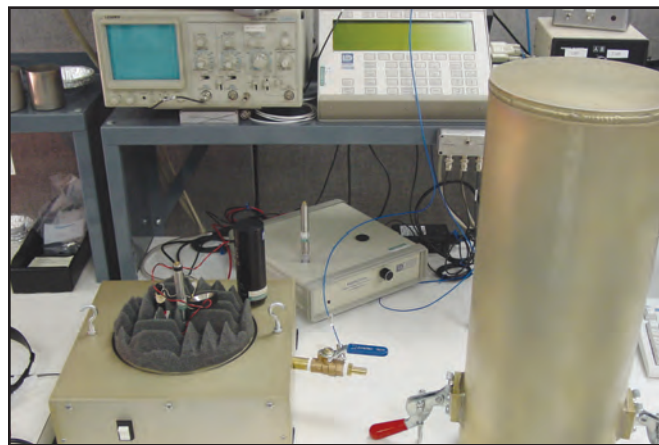

Microphone Electrostatic Calibration

Test base and enclosure isolates unit under test from ambient noise and adjusts for barometric pressures, while voltage insertion generates excitation for reference comparative results.

Acoustic Calibration Services

Voltage Insertion Method (IEC 1094 compliant mics)

- Speakerphone calibrator
- A2LA accredited for sensitivity at 250 Hz, 114 dB SPL
- Measurement uncertainty ± 0.20 dB
- Sensitivity vs. pressure variation testing also available

Electrostatic Actuator

- Frequency response test to 126 kHz

Calibration Services

Dynamic Pressure Sensor Calibration Services



Pneumatic Pulse Calibrator - Model 903B02

A manually actuated poppet valve exposes the sensor under test (installed in a small volume manifold) to the step reference pressure, which is contained and regulated within a much larger storage cavity.

Pneumatic Pulse Method (low pressure)

- Strain gage pressure sensor reference
- Manually-actuated poppet valve
- 5 millisecond rise time (nominal)
- 0 to 150 psi (0 to 1 MPa) range
- Accuracy to 0.8% FS



Hydraulic Step Pressure Calibration - Model 905C

High pressure pump exposes unit under test to graduated pressure steps with a dump valve for rapid, full-scale pressure release.



Aronson Step Pressure Calibrator - Model 907A02

A guided mass impacts a plate, which quickly opens a poppet valve. This exposes the sensor under test (installed in a small volume manifold) to the step reference pressure, which is contained and regulated within a much larger storage cavity.

Dynamic Step Pressure Method

- Strain gage pressure sensor reference
- Aronson shockless step pressure generator
- Impact poppet valve with electronic trigger
- <math>< 50 \mu\text{sec}</math> rise time with helium gas (others available)
- 0 to 1000 psi (0 to 7 MPa) range
- Accuracy to 1.3% FS

Hydraulic, Step Method (high pressure)

- Strain gage pressure sensor reference
- Dump valve for negative-going pressure step
- 0 to 100,000 psi (0 to 690 MPa) range
- Accuracy to 1.7% FS

Calibration Services

Dynamic Pressure Sensor Calibration Services

Hydraulic, Dynamic Impulse Method (high pressure)

- Shock acceleration sensor reference
- Mass-impacted piston
- 0 to 100,000 psi (0 to 690 MPa) range
- 7 millisecond pulse width

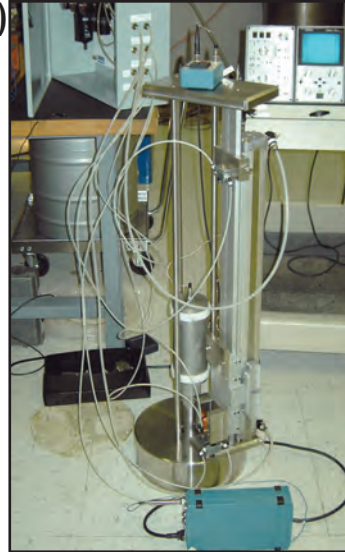

High Pressure Hydraulic Impulse Calibration (to 100,000 psi)

Pneumatic control elevates a large mass, which, when dropped, impacts a piston in a hydraulic cylinder to generate a pressure pulse in a two-port manifold for reference comparative calibration.

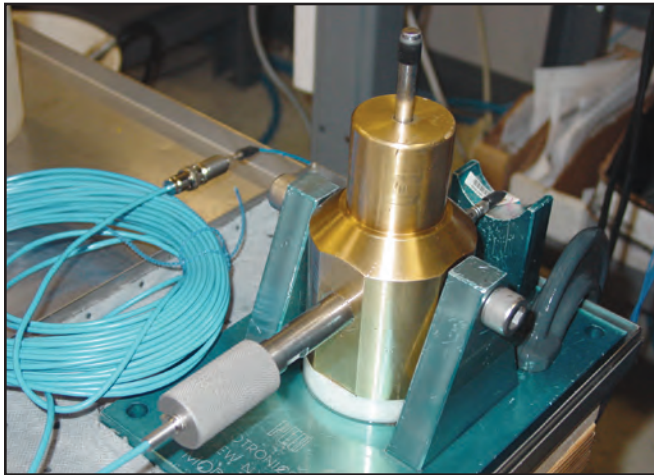

Medium Pressure Hydraulic Impulse Calibration (to 20,000 psi) - Model 913B02

The piston rod on top is struck by a mass to generate a pressure pulse in the two-port manifold for reference comparative calibration.

Hydraulic, Dynamic Impulse Method (medium pressure)

- Mass-impacted piston
- 0 to 20,000 psi (0 to 138 MPa) range
- 6 millisecond pulse width



Pistonphone Kit - Model 915A01

Generates a constant sound pressure level at a controlled frequency for calibrating high-intensity acoustic sensors in the field.

Pistonphone Method

- 124 dB SPL reference at 250 Hz
- Accuracy to 0.45 dB of reading

Calibration Services

Static Pressure Sensor Calibration Services



Pressure Sensor Absolute Calibration

This deadweight tester utilizes precision weights and piston diameters to provide an accurate force-per-unit-area reference of static pressure. Step pressures can also be obtained by quickly venting the system.

Hydraulic Deadweight Tester Method

- 0 to 20,000 psi (0 to 138 MPa) range
- Accuracy of $\pm 1.0\%$ FS



Static Pressure Comparison Calibration

Pressure sensor is exposed to nitrogen pressurized manifold with output compared to reference standard sensor.

Pneumatic Comparator (Nitrogen gas)

- 0 to 10,000 psi (0 to 69 MPa) range
(0.021% FS accuracy)
- 0 to 1000 psi (0 to 7 MPa) range
(0.015% FS accuracy)

Torque Sensor and Load Cell Calibration

PCB® offers calibration services for strain gage torque sensors and load cells. Each test is comprised of five points in both ascending and descending increments. Torque sensors are calibrated in both clockwise and counterclockwise directions. Load cells are calibrated in both tension and compression. Sensitivity, non-linearity, hysteresis, and shunt calibration data are provided.



Calibration Services

Torque Sensor and Load Cell Calibration

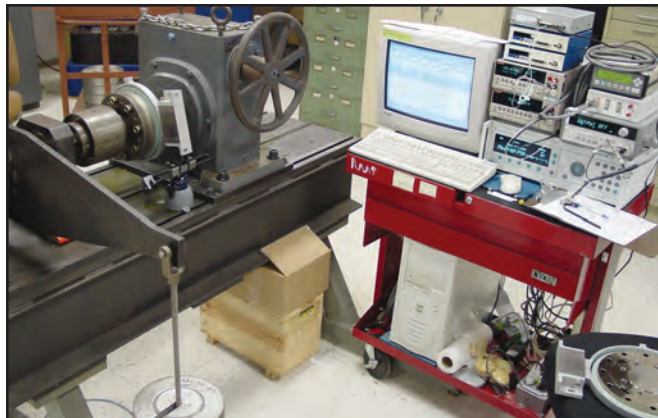

Torque Sensor Absolute Calibration

Otherwise known as a "torque arm", known weights are suspended from the beam at known distances from the sensor's axis of symmetry.



Load Cell Absolute Calibration

Accurate dead weights are utilized for testing against basic physical parameters.

Torque Sensor Calibration Services

Dead Weight and Beam Length

- 10 to 25,000 in-lb (1.1 to 2800 N-m) range
- Accuracy to 0.04% FS

Back-to-Back with Reaction Torque Reference

- 25,000 to 100,000 in-lb (2800 to 11,300 N-m) range
- Accuracy to 0.14% FS

Load Cell and Beam Length

- 100,000 to 500,000 in-lb (11,300 to 56,500 N-m) range
- Accuracy to 0.09% FS

Load Cell Calibration Services

Deadweight Method

- 0 to 500 lb (0 to 2.224 N) range
- Accuracy to 0.04% FS

Strain Gage Reference

- 100 to 10,000 lb (445 to 45,000 N) range
- Accuracy to 0.06% FS

Strain Gage Reference - High Force Stand

- 10,000 to 100,000 lb (45,000 to 445,000 N) range
- Accuracy to 0.08% FS

Dynamic Force Sensor Calibration Services

Strain Gage Reference

- 0 to 100,000 lb (0 to 445,000 N) range
- Accuracy to 1.0% FS



Load Cell Comparison Calibration

A large, hydraulic press generates compressive loads for reference comparative testing.

The Modal Shop Calibration Equipment



Accelerometer Calibration and Testing

The Accelerometer Calibration Workstation Model 9155 features accurate back-to-back comparison calibration of ICP® (IEPE), and charge mode piezoelectric accelerometers in accordance with ISO 16063-21. The 9155 system can also calibrate Piezoresistive, capacitive, and velocity sensors via available options. Other configurations offer automated TEDS sensor updating, linearity checking, low frequency calibration down to 0.25 Hz, shock calibration and a host of shaker options.

The 9155 system is a turnkey solution, providing all necessary components "out-of-the-box." Principal components of the 9155 system are the Windows® PC controller, automated user software, printer and data acquisition hardware. Additional options configure the system with proper accelerometer signal conditioning, calibration grade shaker, power amplifier and reference accelerometer.

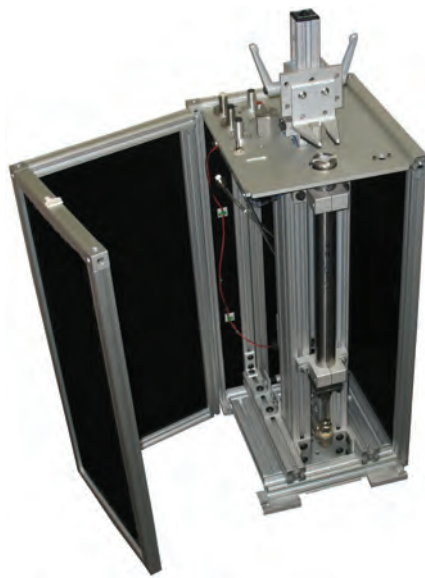

Shock Calibration and Testing

The PneuShock™ Model 9525C actuator provides shock inputs for accurate and consistent sensitivity calibrations at high acceleration levels. Shocks are created at accelerations from 20g to 10 kg using a pneumatically operated projectile to strike an anvil and excite the sensor. By controlling both the level and the duration of the air pressure applied and using a variety of impact anvils of different mass and tip stiffness, the user gains greater control and consistency of the impacts.

The PneuShock™ actuator is supplied as part of a turnkey system Model K9525C which includes an ICP® reference accelerometer, PCB® Model 301A12, for calibrations according to ISO 16063-22. Printed certificates fulfill the requirements set forth by ISO 17025 for calibration certificates and are fully customizable using the Microsoft Excel environment.



Acoustic Calibration

The Precision Acoustic Calibration Workstation Model 9350C is an automated, accurate, turnkey, PC-based system. The 9350C offers cost-effective calibration of ¼", ½" and 1" microphone cartridges (open-circuit sensitivity), microphone cartridges with preamplifiers (closed-circuit sensitivity), as well as microphone frequency response function. Easy operation combined with the proven stepped sine excitation method provide fast and reliable high-volume transducer calibrations.

The 9350C system also provides conformance testing of microphone preamplifiers and acoustic calibrators: including pistonphones as well as speaker phone based calibrators. Sophisticated system verification procedures function to assure a stable, consistent operating environment.



The Modal Shop

10310 Aerohub Boulevard, Cincinnati, OH 45215 USA
E-mail: info@modalshop.com • Toll free: 800-860-4867
Phone: 513-351-9919 • Fax: 513-458-2172
Web site: www.modalshop.com

The Modal Shop Products

PCB Piezotronics' sister company, The Modal Shop, based in Cincinnati, Ohio, USA, specializes in sound and vibration sensing systems for the multichannel, acoustics, modal, vibration testing and NVH markets. Electrodynamic shakers, calibration systems and modal testing equipment are available, in addition to sensors, test equipment rental and application engineering support.

Highlights

- Mini shakers
- SmartShaker™ w/ Integrated Amplifier
- Modal shakers
- Dual purpose design
- Modal and general vibrate

Electrodynamic Exciter Family

The electrodynamic exciter family includes compact size shakers rated from 110 lbf (489 N) down to 4.5 lbf (20 N). Available designs include the revolutionary new SmartShaker™ with integrated power amplifier, a variety of mini, through-hole modal, dual purpose platform and accelerometer calibration shaker, and the new SmartAmp™ power amplifiers. These transducers are ideal for applications ranging from experimental modal analysis and general vibration testing of small components and sub-assemblies to accelerometer calibration.

Electrodynamic Shaker Products

							
Model Number	2004E / 2007E	K2004E01 / K2007E01	2025E	2060E	2100E11	2075E	2110E
Max Force* lbf (N) pk	4.5(20) / 7(31)	4.5(20) / 7(31)	13 (58)	60 (267)	100 (440)	75 (334)	110 (489)
Stroke, in pk-pk	0.2 / 0.5	0.2 / 0.5	0.75	1.4	1	1	1
Weight, lb (kg)	7 (3)	7 (3)	13 (6)	37 (17)	33 (15)	35 (16)	54 (25)
Max Frequency	9 kHz / 11 kHz	9 kHz / 11 kHz	9 kHz	6 kHz	5.4 kHz	6.5 kHz	6.5 kHz
Notes							
*system dependent. For complete specifications on shakers, systems, amplifiers, and other structural test products and accessories (shaker stand, AirRide mounts, etc), please visit www.modalshop.com .							

Transducer Electronic Data Sheet (TEDS)

Most PCB® accelerometers are available to order with TEDS functionality by specifying the unit's model number with a "TLD" prefix. Model 400B76 TEDS Sensor Interface Kit provides users with full access to support both reading and writing information to the TEDS sensor (e.g. sensor sensitivity). An intuitive graphical interface allows data to be transferred over a USB port to and from the sensor with a single mouse click.

Model 400B76 supports IEEE 1451.4 compliant TEDS sensors including: single axis and triaxial accelerometers, impact hammers, impedance heads, charge amplifiers, microphones and microphone preamplifiers. Model 400B76 supports more TEDS templates than any other available TEDS Sensor Interface Kit.

Rotational Speed Measurements

The LaserTach™ ICP® tachometer senses the speed of rotating equipment and outputs an analog voltage signal for referencing vibration signals to shaft speed. The sensor allows for measurements up to 30,000 RPM from distances as far as 20in (51cm). A BNC jack connects the unit to any constant current excitation source (> 3mA).

The PulseDriver™ is a preamplifier/divider for tachometer signals. It conditions a voltage pulsetrain from a magnetic pickup or similar sensor for input to standard ICP® sensor signal conditioners. An adjustable divider circuit divides the pulse train down to a square wave with a fundamental frequency equal to the shaft speed.

Common Options for PCB® Products

PCB® designs and manufactures thousands of custom product variations. These range from minor modifications of sensitivity or mounting configuration, all the way to complex projects built from the ground-up based on customer specifications for the most demanding applications. PCB® also provides a simplified format for ordering many custom versions of our stock and standard products through the use of prefixes. What follows is a list of the most popular prefixes and a brief explanation of their function. Please contact PCB® to see if the prefix of interest can be combined with the model in which you are interested.

Option “A”— Adhesive Mount (e.g. A353B18)

This option designates the removal of the integral stud so that the sensor has a flat bottom for direct adhesive mounting. Note that the frequency response will not be as high as with stud mounting and that higher frequency response will be achieved with stiffer adhesives.

Option “CA”— Ablative Coating (e.g. CA102B04)

This option designates that the diaphragm of the pressure sensor is coated with an ablative material in order to minimize the effects of thermal shock.

Option “E”— Emralon Coating (e.g. CA102B04)

This option designates that the diaphragm of the pressure sensor is coated with Emralon in order to provide ground isolation.

Option “HT”— High Temperature Operation (e.g. HT356A02)

An adjustment to the built-in microelectronic circuitry permits sensor operation to temperatures that exceed the standard temperature range. Typically, the low frequency range will be somewhat compromised. The published specification sheet, for the base model, will indicate to what extent the low frequency response is compromised.

Option “J”— Ground Isolation (e.g. J353B01, J225C)

The ground isolation option provides an electrical isolation of

$>10^8$ ohms between the sensor and the test structure. Isolating the sensor from the test object reduces noise induced by electrical ground loops. For accelerometers, attaching the ground isolation base reduces the upper frequency range slightly. The “J” option is only needed when ground isolation is required and the sensor is being stud mounted. If adhesively mounting, the accelerometer will include an adhesive base that also provides ground isolation. Physical dimensions may change so refer to model drawing for details.



Option “M”— Metric Mounting Thread (e.g. M353B15, M102B16)

This option is used for applications requiring a metric thread for installation. On models for which a separate mounting stud or cap screw is provided, this option supplies an adaptor stud or cap screw with a metric installation thread. For models that incorporate an integral mounting stud, the optional unit includes an integral metric threaded stud. There are no compromises to any specification when installing with a metric thread. Note: many models are supplied with both SAE and Metric mounting hardware.

Option “P”— Positive Polarity Element (e.g. P357B03)

When the phase of the output signal is important, especially for timing and multi-channel applications, it may be necessary to reverse the polarity of the output signal to correspond to the inverting characteristics of the signal conditioner being used. Most charge amplifiers invert the measurement signal and are typically used with charge output sensors having a negative signal polarity. In cases where the signal conditioner is a non-inverting device, it may be desirable to use a positive polarity sensor. This option provides a positive polarity charge output sensor without compromise to any other specification.

Option “Q”— Extended Low Frequency (e.g. Q353B01)

Accurate measurements below 1 Hz can often be achieved

NOTE:

Adding, (or combining) some of these options may result in a custom sensor. Contact PCB® for further information.
716-684-0001

Common Options for PCB® Products

by factory modification of the internal microelectronics of the sensor. For most sensors the DTC is extended to 10 seconds, which provides $-5\% @ 0.05 \text{ Hz}$. For some smaller sensors the DTC is extended to 5 seconds, which provides $-5\% @ 0.1 \text{ Hz}$. For accurate low-frequency measurements, be certain the signal conditioner is DC coupled. For practical reasons, lower sensitivity sensors ($\leq 50 \text{ mV/g}$) with extended low frequency are recommended only for long-duration shock pulse measurements associated with package or drop testing.

Option “RH”— RoHS Compliant (e.g. RH201A76)

This option indicates that the model is compliant to the European Union's Directive 2002/95/EC on Restriction of Hazardous Substances.

Option “S”— Stainless Steel Diaphragm (e.g. S112A22)

This option designates that the diaphragm of the pressure sensor is made from Stainless Steel to provide protection from corrosion.

Option “T”— Transducer Electronic Data Sheet (TEDS) (e.g. T333B32)



The “TEDS” option provides a sensor with an on-board digital memory. This memory stores valuable information such as sensor model, serial number, sensitivity value, last calibration date, etc. Via command from an appropriately outfitted signal conditioner, the sensor is digitally addressed and the information in the memory is downloaded. The information is then utilized by the data acquisition system to aid in automating such tasks as coordinate mapping and data bookkeeping. This plug-and-play capability is in accordance with the international standard defined by IEEE P1451.4 Users should verify with their analyzer/software vendor to see what versions and templates are supported in order to select the proper PCB “TEDS” option.

Option “TLA”— TEDS in LMS International – Free Format

Option “TLB”— TEDS in LMS International – Automotive Format

Option “TLC”— TEDS in LMS International – Aeronautical Format (e.g. TLA333B32 or TLB333B32 or TLC333B32)

Option “TLD”— TEDS Compliant with IEEE 1451.4 and now the most common of the (5) TEDS variations PCB® offers. (e.g. TLD333B32)

Option “W”— Water Resistant Connection (e.g. W353B01/002C10)

The water resistant option provides a cable directly attached and sealed to the sensor's electrical connector with o-rings and heat-shrink tubing. This sealing process guards against contamination from dirt and fluids and permits short-term underwater use. The model number is constructed by placing the letter “W” as a prefix to the model number, then adding a slash (/) after the model number, followed by the type of cable, length, and appropriate connectors. (See cables/accessories section for a description of cables and connectors). The example, a W353B01/002C10, designates a water resistant sealing of a 002C10 cable to a 353B01 accelerometer. Metric lengths can be defined by adding an “M” in front of the cable type, e.g. W353B01/M002C10 designates a 10-meter cable length.

Option “Y”— Consignment (e.g. Y352C22, Y480E09)

This option indicates a model that has been previously used but is fully within specification. These models are sometimes sold and would have a discounted price.



Custom Designed Sensor Examples

In addition to the common options noted in the previous section, customers regularly request model adjustments to fit their specific implementation and measurement needs. Some of these requests include adjustments to sensitivity, range, frequency response, mounting, and cabling. These adjustments can often be made for a certain premium over the base model.

PCB® has accommodated many of these requests and created numerous special models including the following examples. If you have a specific measurement need, please contact a PCB Application Engineer at 1-800-828-8840 to discuss the details.



Model 352M168 ICP® Single Axis Accelerometer
Standard Model 352C04 modified as follows:

- Electrical Ground Isolation
- Extended High Frequency range out to 20 kHz to comply with MIL-STD-740-2 Testing



Model 356M54 ICP® Triaxial Accelerometer
Standard Model 356B07 modified as follows:

- Integral cable assembly that is molded on the sensor
- Special Waterblock cable designed to resist wicking if the jacket is nicked
- Hydrottested to 200 psi

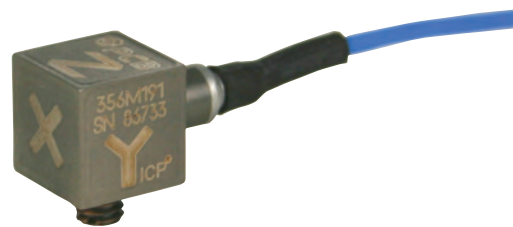

Model 356M191 ICP® Triaxial Accelerometer
Standard Model 356A32 modified as follows:

- Lower 20 mV/g sensitivity and larger 200 g measurement range
- 20kg Shock Survivability
- Integral Cable Assembly
- Built-in Single Pole low pass filter
- Multiple Special Calibration requirements



Model J351B41 Cryogenic ICP® Accelerometer

- Thermally stable Quartz sensing element
- Special amplifier assembly for long term reliable operation at cryogenic temperatures
- Electrical Ground Isolation
- Operating temperature down to -320 °F (-196 °C)
- Each unit tested in liquid Nitrogen prior to shipment

Custom Designed Sensor Examples



Model 200M113 ICP® Force Sensor
Standard Model 200C20 modified as follows:

- Height decreased from 0.500 inches to 0.395 inches
- No tapped threaded mounting provisions



Model 224M10 ICP® Force Sensor
Standard Model 224C modified as follows:

- Right angle 10-32 electrical connector
- Allows optional cable to exit parallel to the sensor body for maximum radial clearance around the sensor



Model 102M174 ICP® Pressure Sensor
Standard Model 112A04 modified as follows:

- Mounted in a 3/8-24 off-ground adapter
- High temperature ablative coating on diaphragm to delay effects of thermal flash



Model 112M231 ICP® Pressure Sensor
Standard Model 112A21 modified as follows:

- Stainless steel diaphragm
- Emralon coating added to off-ground the sensor
- Sensor is hermetically sealed.

Contact a PCB® Application Engineer
to discuss your custom sensor
requirements.
716-684-0001

Introduction to Piezoelectric Sensors

Introduction

Recent developments in state-of-the-art integrated circuit technology have made possible great advances in piezoelectric sensor instrumentation. The intent of this guide is to enhance the usefulness of today's advanced sensor concepts by acquainting the user with the advantages, limitations and basic theory of sensor signal conditioning.

This educational guide will deal with the following types of basic sensor instrumentation:

- 1 Charge Output Sensors — high output impedance, piezoelectric sensors (without built-in electronics) which typically require external charge or voltage amplifiers for signal conditioning.
- 2 Internally Amplified Sensors — low impedance, piezoelectric force, acceleration and pressure-type sensors with built-in, integrated circuits. (ICP® is a registered trademark of PCB Piezotronics, Inc., Inc., which uniquely identifies PCB® sensors incorporating built-in electronics.)

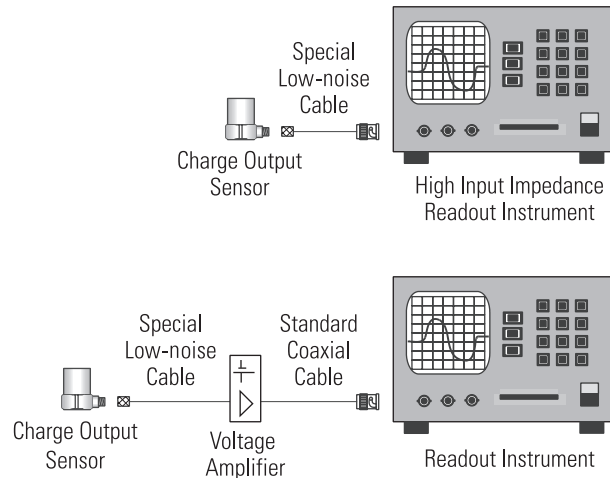

Figure 1. Typical Voltage Mode Systems

Conventional Charge Output Sensors

Historically, nearly all dynamic measurement applications utilized piezoelectric charge output sensors. These sensors contain only a piezoelectric sensing element (without built-in electronics) and have a high impedance output signal.

The main advantage of charge output sensors is their ability to operate under high temperature environments. Certain sensors have the ability to withstand temperatures exceeding +1000 °F (+538 °C). However, the output generated by piezoelectric sensing crystals is extremely sensitive to corruption from various environmental factors. Low-noise cabling must be used to reduce radio frequency interference (RFI) and electromagnetic interference (EMI.) The use of tie wraps or tape reduces triboelectric (motion-induced) noise. A high insulation resistance of the sensor and cabling should be maintained to avoid drift and ensure repeatable results.

To properly analyze the signal from charge output sensors, the high impedance output must normally be converted to a low impedance voltage signal. This can be done directly by the input of the readout device or by in-line voltage and charge amplifiers. Each case will be considered separately.

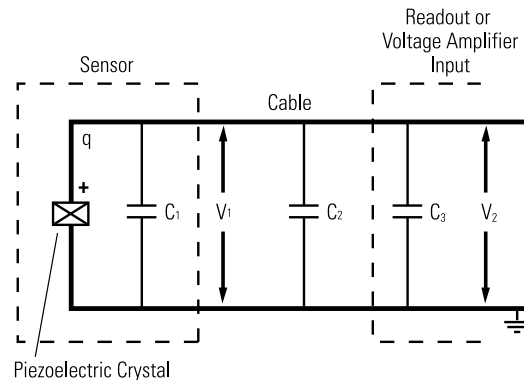

Figure 2. Voltage Mode System Schematic

Voltage Mode (and Voltage Amplified) Systems

Certain piezoelectric sensors exhibit exceptionally high values of internal source capacitance and can be plugged directly into high impedance (>1 Megohm) readout devices such as oscilloscopes and analyzers. Others with a low internal source capacitance may require in-line signal conditioning such as a voltage amplifier. See **Figure 1**.

A schematic representation of these voltage mode systems including sensor, cable and input capacitance of voltage amplifier or readout device is shown below in **Figure 2**. The insulation resistance (resistance between signal and ground) is assumed to be large (>10¹² ohms) and is therefore not shown in the schematic.

The open circuit (e.g., cable disconnected) voltage sensitivity V_1 (Volts per psi, lb or g) of the charge output sensor can be represented mathematically by **Equation 1**.

$$V_1 = q / C_1 \quad (\text{Equation 1})$$

where: q = basic charge sensitivity in pC per psi, lb or g
 C_1 = Internal sensor (crystal) capacitance in pF
 (p = pico = 1×10^{-12} ; F = farad)

Introduction to Piezoelectric Sensors

The overall system voltage sensitivity measured at the readout instrument (or input stage of the voltage amplifier) is the reduced value shown in **Equation 2**.

$$V_2 = q / (C_1 + C_2 + C_3) \quad (\text{Equation 2})$$

where: C_2 = cable capacitance in pF
 C_3 = input capacitance of the voltage amplifier or readout instrument in pF

According to the law of electrostatics (**Equations 1 and 2**), sensing elements with a low capacitance will have a high voltage sensitivity. This explains why low-capacitance quartz sensors are used predominantly in voltage systems.

This dependency of system voltage sensitivity upon the total system capacitance severely restricts sensor output cable length. It explains why the voltage mode sensitivity of high impedance-type piezoelectric sensors is measured and specified with a given cable capacitance. If the cable length and/or type is changed, the system must be recalibrated. These formulas also show the importance of keeping the sensor input cable/connector dry and clean. Any change in the total capacitance or loss in insulation resistance due to contamination can radically alter the system characteristics. Furthermore, the high-impedance output signal makes the use of low-noise coaxial cable mandatory and precludes the use of such systems in moist or dirty environments, unless extensive measures are taken to seal cables and connectors.

From a performance aspect, voltage mode systems are capable of linear operation at high frequencies. Certain sensors have frequency limits exceeding 1 MHz, making them useful for detecting shock waves with a fraction of a microsecond rise time. However, care must be taken, as large capacitive cable loads may act as a filter and reduce this upper operating frequency range.

Unfortunately, many voltage amplified systems have a noise floor (resolution) which may be an order of magnitude higher than equivalent charge amplified systems. For this reason, high-resolution ICP®, and/or charge amplified sensors, are typically used for low-amplitude dynamic measurements.

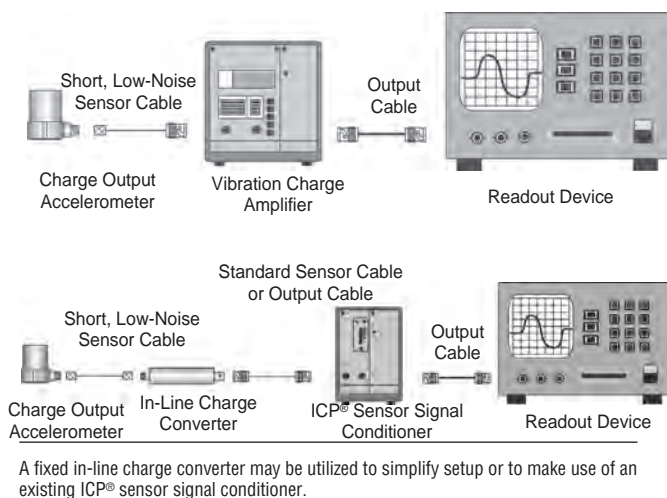

Figure 3. Typical Charge Amplified System

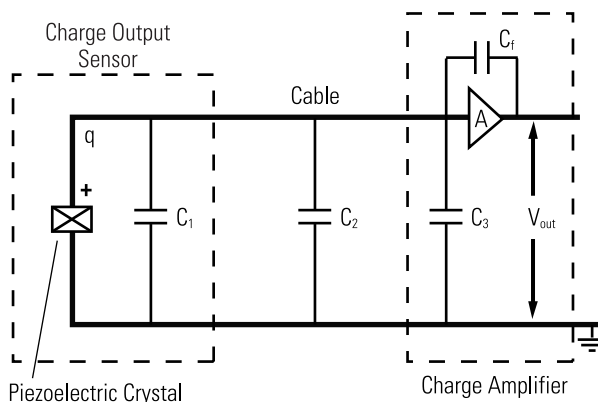

Figure 4. Charge Amplified System Schematic

Charge Amplified Systems

A typical charge amplified measurement system is shown in **Figure 3**.

A schematic representation of a charge amplified system, including sensor, cable and charge amplifier, is shown in **Figure 4**. Once again, the insulation resistance (resistance between signal and ground) is assumed to be large ($>10^{12}$ ohms) and is therefore not shown in the schematic.

In this system, the output voltage is dependent only upon the ratio of the input charge, q , to the feedback capacitor, C_f , as shown in **Equation 3**. For this reason, artificially polarized polycrystalline ceramics, which exhibit a high charge output, are used in such systems.

$$V_{out} = q / C_f \quad (\text{Equation 3})$$

There are serious limitations with the use of conventional charge amplified systems, especially in field environments or when driving long cables between the sensor and amplifier. First, the electrical noise at the output of a charge amplifier is directly related to the ratio of total system capacitance ($C_1 + C_2 + C_3$) to the feedback capacitance (C_f). Because of this, cable length should be limited, as was the case in the voltage mode system. Secondly, because the sensor output signal is of a high impedance type, special low-noise cabling must be used to reduce charge generated by cable motion (triboelectric effect) and noise caused by excessive RFI and EMI.

Also, care must be exercised to avoid degradation of insulation resistance at the input of the charge amplifier to avoid the potential for signal drift. This often precludes the use of such systems in harsh or dirty environments, unless extensive measures are taken to seal all cables and connectors.

While many of the performance characteristics are advantageous as compared to voltage mode systems, the per-channel cost of charge amplified instrumentation is typically very high. It is also impractical to use charge amplified systems above 50 or 100 kHz, as the feedback capacitor exhibits filtering characteristics above this range.

Introduction to Piezoelectric Sensors

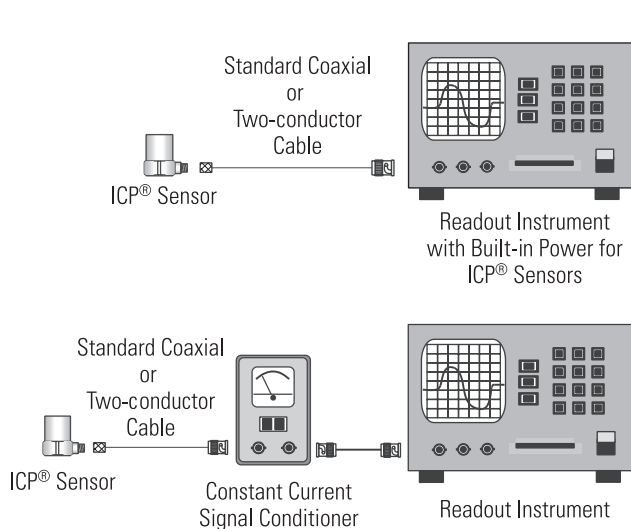

Figure 5. Typical ICP® Sensor Systems

ICP® Sensors

ICP® is a term that uniquely identifies PCB's piezoelectric sensors with built-in microelectronic amplifiers. (ICP® is a registered trademark of PCB Piezotronics, Inc., Inc.) Powered by constant current signal conditioners, the result is an easy-to-operate, low-impedance, two-wire system as shown in **Figure 5**.

In addition to ease-of-use and simplicity of operation, ICP® sensors offer many advantages over traditional charge output sensors, including:

- 1 Fixed voltage sensitivity, independent of cable length or capacitance.
- 2 Low output impedance (<100 ohms) allows signals to be transmitted over long cables through harsh environments with virtually no loss in signal quality.
- 3 Two-wire system accommodates standard low-cost coaxial or other two-conductor cables.
- 4 High quality, voltage output, compatible with standard readout, recording or acquisition instruments.
- 5 Intrinsic sensor self-test feature by monitoring sensor output bias voltage.
- 6 Low per-channel cost as sensors require only low-cost, constant current signal conditioners and ordinary cables.
- 7 Reduced system maintenance.
- 8 Direct operation into readout and data acquisition instruments, which incorporate power for use with PCB's ICP® sensors.

Figure 6 schematically shows the electrical fundamentals of typical quartz and ceramic ICP® sensors. These sensors are comprised of a basic piezoelectric transduction mechanism (which has an output proportional to force, pressure, acceleration, or strain, depending on the sensor type) coupled to a highly reliable integrated circuit.

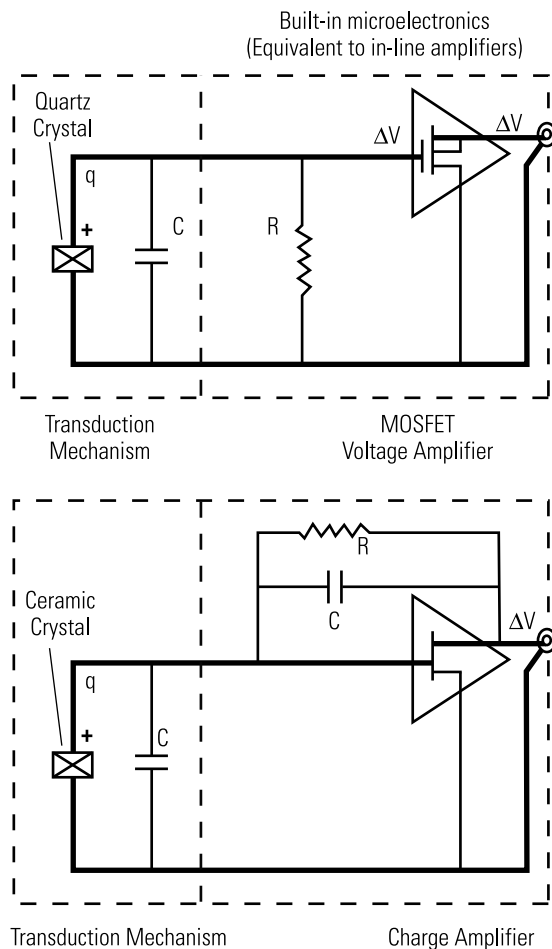

Figure 6. Basic Quartz and Ceramic ICP® Sensors

Two types of integrated circuits are generally used in ICP® sensors: voltage amplifiers and charge amplifiers. Low capacitance quartz sensing elements exhibit a very high voltage output (according to $V = q/C$) and are typically used with MOSFET voltage amplifiers. Ceramic sensing elements which exhibit a very high charge output are normally coupled to charge amplifiers.

The theory behind ICP® quartz sensing technology will first be explained. The process begins when a measurand, acting upon the piezoelectric sensing element, produces a quantity of charge referred to as Δq . This charge collects in the crystal capacitance, C , and forms a voltage according to the law of electrostatics: $\Delta V = \Delta q/C$. Because quartz exhibits a very low capacitance, the result is a high-voltage output, suitable for use with voltage amplifiers. The gain of the amplifier then determines the sensor sensitivity.

This ΔV instantaneously appears at the output of the voltage amplifier, added to an approximate +10 VDC bias level. This bias level is constant and results from the electrical properties of the amplifier itself. (Normally, the bias level is removed by an external signal conditioner before analyzing any data. This concept will be fully explained later.) Also, the impedance level at the output of the sensor is less than 100 ohms. This makes it easy to drive long cables through harsh environments with virtually no loss in signal quality.

Introduction to Piezoelectric Sensors

ICP® sensors which utilize ceramic sensing elements generally operate in a different manner. Instead of using the voltage generated across the crystal, ceramic ICP® sensors operate with charge amplifiers. In this case, the high-charge output from the ceramic crystal is the desirable characteristic.

The sensor's electrical characteristics are analogous to those described previously in charge mode systems, where the voltage output is simply the charge generated by the crystal divided by the value of the feedback capacitor. (The gain of the amplifier (mV/pC) ultimately determines the final sensitivity of the sensor). In this case, many of the limitations have been eliminated. That is, all of the high-impedance circuitry is protected within a rugged, hermetic housing. Concerns or problems with contamination and low-noise cabling are eliminated.

A quick comparison of integrated circuit voltage and charge amplifiers is provided below:

Voltage Amplifier	Charge Amplifier
High Frequency (>1 MHz)	Limited Frequency (~100 kHz)
Low-cost	More Costly
Non-inverting	Inverting
Typically used with Quartz	Typically used with Ceramic
Small Size	Low-noise

Note that the schemata in **Figure 6** also contain an additional resistor. In both cases, the resistor is used to set the discharge time constant of the RC (resistor-capacitor) circuit. This will be further explained in the following pages.

In-line Charge and Voltage Amplifiers

Certain applications (such as high temperature testing) may require integrated circuits to be removed from the sensor. For this reason, a variety of in-line charge amplifiers and in-line voltage amplifiers are available. Operation is identical to that of an ICP® sensor, except that the cable connecting the sensor to amplifier carries a high-impedance signal. Special precautions, like those discussed earlier in the charge and voltage mode sections, must be taken to ensure reliable and repeatable data.

Powering ICP® Systems

A typical sensing system including a quartz ICP® sensor, ordinary two-conductor cable and basic constant current signal conditioner is shown in **Figure 7**. All ICP® sensors require a constant current power source for proper operation. The simplicity and the principle of two-wire operation can be clearly seen.

The signal conditioner consists of a well-regulated 18 to 30 VDC source (battery or line-powered), a current-regulating diode (or equivalent constant current circuit), and a capacitor for decoupling (removing the bias voltage) the signal. The voltmeter (V_M) monitors the sensor bias voltage (normally 8 to 14 VDC) and is useful for checking sensor operation and detecting open or shorted cables and connections.

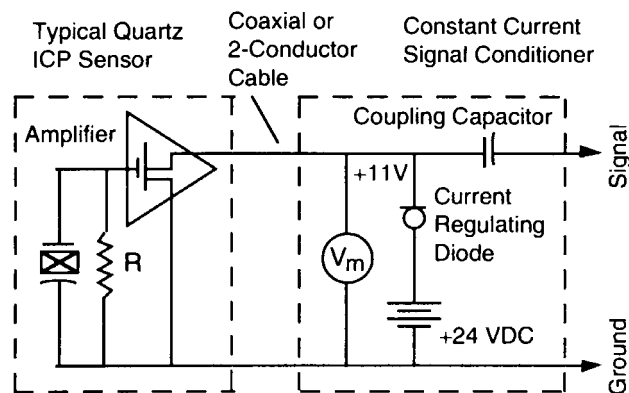

Figure 7. Typical ICP® Sensor System

The current-regulating diode is used instead of a resistor for several reasons. The very high dynamic resistance of the diode yields a source follower gain which is extremely close to unity and independent of input voltage. Also, the diode can be changed to supply higher currents for driving long cable lengths. Constant current diodes, as shown in **Figure 8**, are used in all of PCB's battery powered signal conditioners. (The correct orientation of the diode within the circuit is critical for proper operation.) Except for special models, standard ICP® sensors require a minimum of 2 mA for proper operation.

Present technology limits this diode type to 4 mA maximum rating; however, several diodes can be placed in parallel for higher current levels. All PCB line-powered signal conditioners use higher capacity (up to 20 mA) constant current circuits in place of the diodes, but the principle of operation is identical.

Decoupling of the data signal occurs at the output stage of the signal conditioner. The 10 to 30 μF capacitor shifts the signal level to essentially eliminate the sensor bias voltage. The result is a drift-free AC mode of operation. Optional DC coupled models eliminate the bias voltage by use of a DC voltage level shifter.

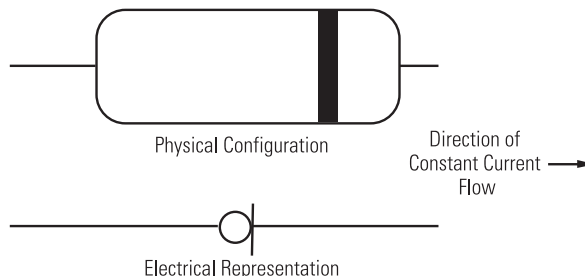

Figure 8 Constant Current Diode

Introduction to Piezoelectric Sensors

Effect of Excitation Voltage on the Dynamic Range of ICP® Sensors

The specified excitation voltage for all standard ICP® sensors and amplifiers is generally within the range of 18 to 30 volts. The effect of this range is shown in **Figure 9**.

To explain the chart, the following values will be assumed:

- V_B = Sensor Bias Voltage = 10 VDC
- V_{S1} = Supply Voltage 1 = 24 VDC
- V_{E1} = Excitation Voltage 1 = $V_{S1} - 1 = 23$ VDC
- V_{S2} = Supply Voltage 2 = 18 VDC
- V_{E2} = Excitation Voltage 2 = $V_{S2} - 1 = 17$ VDC
- Maximum Sensor Amplifier Range = ± 10 volts

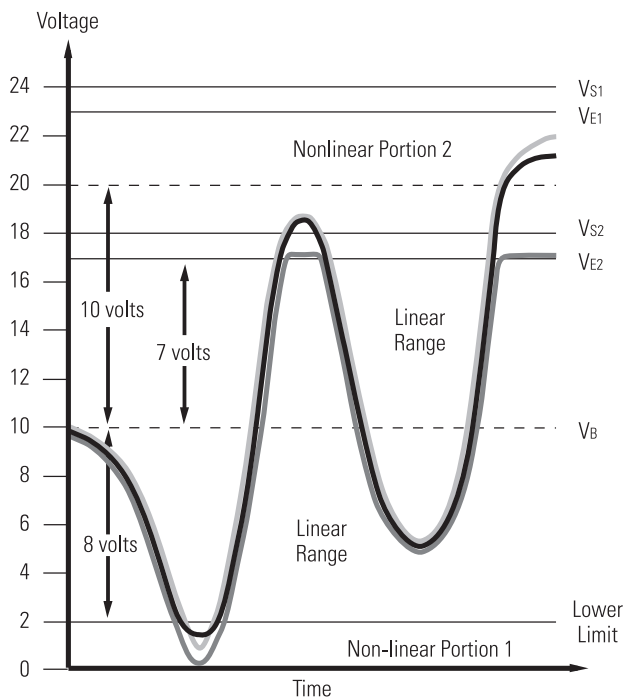

Figure 9.
 — Input Measurand (signal)
 — Output Signal (18 VDC supply)
 — Output Signal (24 VDC supply)

Note that an approximate 1-Volt drop across the current limiting diode (or equivalent circuit) must be maintained for correct current regulation. This is important, as two 12 VDC batteries in series will have a supply voltage of 24 VDC, but will only have a 23 VDC usable sensor excitation level.

The solid curve represents the input to the internal electronics of a typical ICP® sensor, while shaded curves represent the output signals for two different supply voltages.

In the negative direction, the voltage swing is typically limited by a 2 VDC lower limit. Below this level, the output becomes nonlinear (nonlinear portion 1 on graph). The output range in the negative direction can be calculated by:

$$\text{Negative Range} = V_B - 2 \quad (\text{Equation 4})$$

This shows that the negative voltage swing is affected only by the sensor bias voltage. For this case the negative voltage range is 8 volts.

In the positive direction, the voltage swing is limited by the excitation voltage. The output range in the positive direction can be calculated by:

$$\text{Positive Range} = (V_S - 1) - V_B = V_E - V_B \quad (\text{Equation 5})$$

For a supply voltage of 18 VDC, this results in a dynamic output range in the positive direction of 7 volts. Input voltages beyond this point simply result in a clipped waveform as shown.

For the supply voltage of 24 VDC, the theoretical output range in the positive direction is 13 volts. However, the microelectronics in ICP® sensors are seldom capable of providing accurate results at this level. (The assumed maximum voltage swing for this example is 10 volts.) Most are specified to ± 3 , ± 5 or ± 10 volts. Above the specified level, the amplifier is nonlinear (nonlinear portion 2 on graph). For this example, the 24 VDC supply voltage extended the usable sensor output range to $+10/-8$ volts.

Installation General

Please refer to the installation and/or outline drawing included in the sensor manual for mounting preparation and installation techniques. Select desired operating mode (AC or DC coupling) and make sure that cable connectors are tight to provide reliable ground returns. If solder connector adaptors are used, inspect solder joints. If vibration is present, use cable tie-downs, appropriately spaced to avoid cable fatigue. Although ICP® instruments are low-impedance devices, in extreme environments it is advisable to use shielded cables and protect cable connections with heat shrink tubing. Complete installation instructions are provided with each sensor.

Operation

If a PCB® signal conditioner is being used, turn the power on and observe the voltmeter (or LEDs) on the front panel.

Typical indicators are marked as shown in Figure 10. The green area (or LED) indicates the proper bias range for the ICP® sensor and the correct cable connections. A red color indicates a short condition in the sensor, cable, or connections. Yellow means the excitation voltage is being monitored and is an indication of an open circuit.

Introduction to Piezoelectric Sensors

Apparent Output Drift (when AC-coupled)

AC-coupled signal conditioners require sufficient time to charge their internal coupling capacitor. This capacitor must charge through the input resistance of the readout instrument and, if a DC readout is used, the output voltage will appear to drift slowly until charging is complete. A one-megohm readout device will require $5 \times 1 \text{ meg} \times 10 \text{ } \mu\text{F}$ or 50 seconds to essentially complete charging. (Assumes stable operation after five discharge time constants: $5 \times \text{Resistance} \times \text{Capacitance}$. See **Figure 14**)

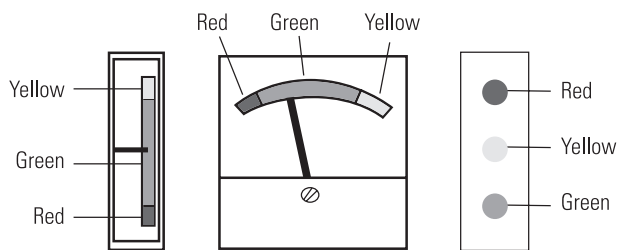

Figure 10. Typical Fault Indicator

High Frequency Response of ICP® Sensors

ICP® sensor systems ideally treat signals of interest proportionally. However, as the frequency of the measurand increases, the system eventually becomes nonlinear. This is due to the following factors:

- 1 Mechanical Considerations
- 2 Amplifier/Power Supply Limitations
- 3 Cable Characteristics

Each of these factors must be considered when attempting to make high frequency measurements.

Mechanical Considerations

The mechanical structure within the sensor most often imposes a high frequency limit on sensing systems. That is, the sensitivity begins to rise rapidly as the natural frequency of the sensor is approached.

$$\omega = \sqrt{(k/m)} \quad \text{(Equation 6)}$$

where: ω = natural frequency
 k = stiffness of sensing element
 m = seismic mass

This equation helps to explain why larger or, more massive sensors, in general, have a lower resonant frequency.

Figure 11, below, represents a frequency response curve for a typical ICP® accelerometer.

It can be seen that the sensitivity rises as frequency increases. For most applications, it is generally acceptable to use this sensor over a range where sensitivity deviates by less than $\pm 5\%$. This upper frequency limit occurs at approximately 20% of the resonant frequency. Pressure and force sensors respond in a similar manner.

Mounting also plays a significant role in obtaining accurate high-frequency measurements. Be certain to consult installation procedures for proper mounting.

Mounting also plays a significant role in obtaining accurate high-frequency measurements. Be certain to consult installation procedures for proper mounting.

Amplifier/Power Supply Limitations

When testing at extremely high frequencies (>100 kHz), the type of sensing system becomes important. In general, voltage amplified systems respond to frequencies on the order of 1 MHz, while most charge amplified systems may respond only to 100 kHz. This is typically due to limitations of the type of amplifier, as well as capacitive filtering effects. For such cases, consult the equipment specifications, or call PCB for assistance.

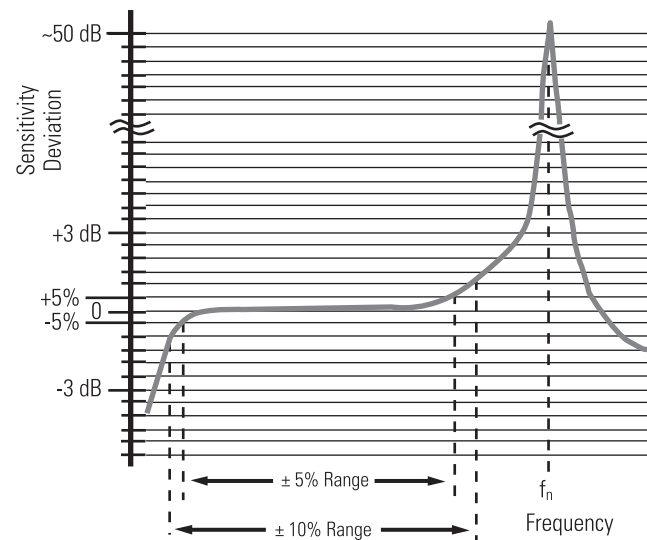

Figure 11. Frequency Response of an ICP® Accelerometer

Cable Considerations and Constant Current Level

Operation over long cables may affect frequency response and introduce noise and distortion when an insufficient current is available to drive cable capacitance.

Introduction to Piezoelectric Sensors

Unlike charge-mode systems, where the system noise is a function of cable length, ICP® sensors provide a high-voltage, low-impedance output, well-suited for driving long cables through harsh environments. While there is virtually no increase in noise with ICP® sensors, the capacitive loading of the cable may distort or filter higher frequency signals, depending on the supply current and the output impedance of the sensor.

Generally, this signal distortion is not a problem with lower frequency testing up to 10 kHz. However, for higher frequency vibration, shock, blast or transient testing over cables longer than 100 ft (30 m), the possibility of signal distortion exists.

The maximum frequency that can be transmitted over a given cable length is a function of both cable capacitance and the ratio of the peak signal voltage to the current available from the signal conditioner, according to:

$$f_{\max} = \frac{10^9}{2\pi CV / (I_C - 1)} \quad (\text{Equation 7})$$

where, f_{\max} = maximum frequency (Hz)
 C = cable capacitance (picofarads)
 V = maximum peak output from sensor (volts)
 I_C = constant current from signal conditioner (mA)
 10^9 = scaling factor to equate units

Note that in this equation, 1 mA is subtracted from the total current supplied to sensor (I_C). This is done to compensate for powering internal electronics. Some specialty sensor electronics may consume more or less current. Contact the manufacturer to determine the correct supply current.

When driving long cables, **Equation 7** shows that, as the length of cable, peak voltage output or maximum frequency of interest increases, a greater constant current will be required to drive the signal.

The nomograph on the facing page (**Figure 13**) provides a simple, graphical method for obtaining expected maximum frequency capability of an ICP® measurement system. The maximum peak signal voltage amplitude, cable capacitance and supplied constant current must be known or presumed.

For example, when running a 100 ft (30.5 m) cable with a capacitance of 30 pF/ft, the total capacitance is 3000 pF. This value can be found along the diagonal cable capacitance lines. Assuming the sensor operates at a maximum output range of 5 volts and the constant current signal conditioner is set at 2 mA, the ratio on the vertical axis can be calculated to equal 5. The intersection of the total cable capacitance and this ratio result in a maximum frequency of approximately 10.2 kHz.

The nomograph does not indicate whether the frequency amplitude response at a point is flat, rising or falling. For precautionary reasons, it is good general practice to increase the constant current (if possible) to the sensor (within its maximum limit) so that the frequency determined from the nomograph is approximately 1.5 to 2 times greater than the maximum frequency of interest.

Note that higher current levels will deplete battery powered signal conditioners at a faster rate. Also, any current not used by the cable goes directly to power the internal electronics and will create heat. This may cause the sensor to exceed its maximum temperature specification. For this reason, do not supply excessive current over short cable runs or when testing at elevated temperatures.

Experimental Test and Long Cables

To determine the high frequency electrical characteristics involved with long cable runs, two methods may be used.

The first method illustrated in **Figure 12** involves connecting the output from a standard signal generator into a unity gain, low-output impedance (<5 ohm) instrumentation amplifier in series with the ICP® sensor. The extremely low-output impedance is required to minimize the resistance change when the signal generator and amplifier are removed from the system. The alternate test method, also shown in **Figure 12**, incorporates a sensor simulator which contains a signal generator and sensor electronics conveniently packaged together.

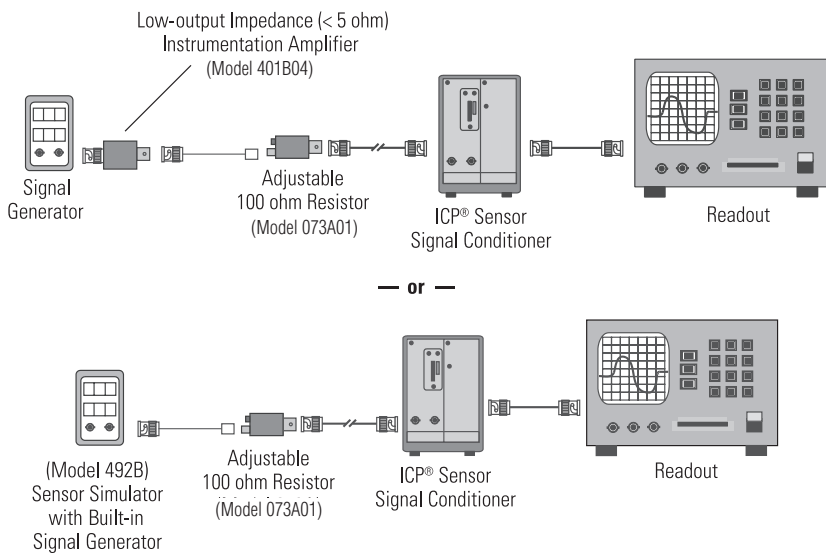
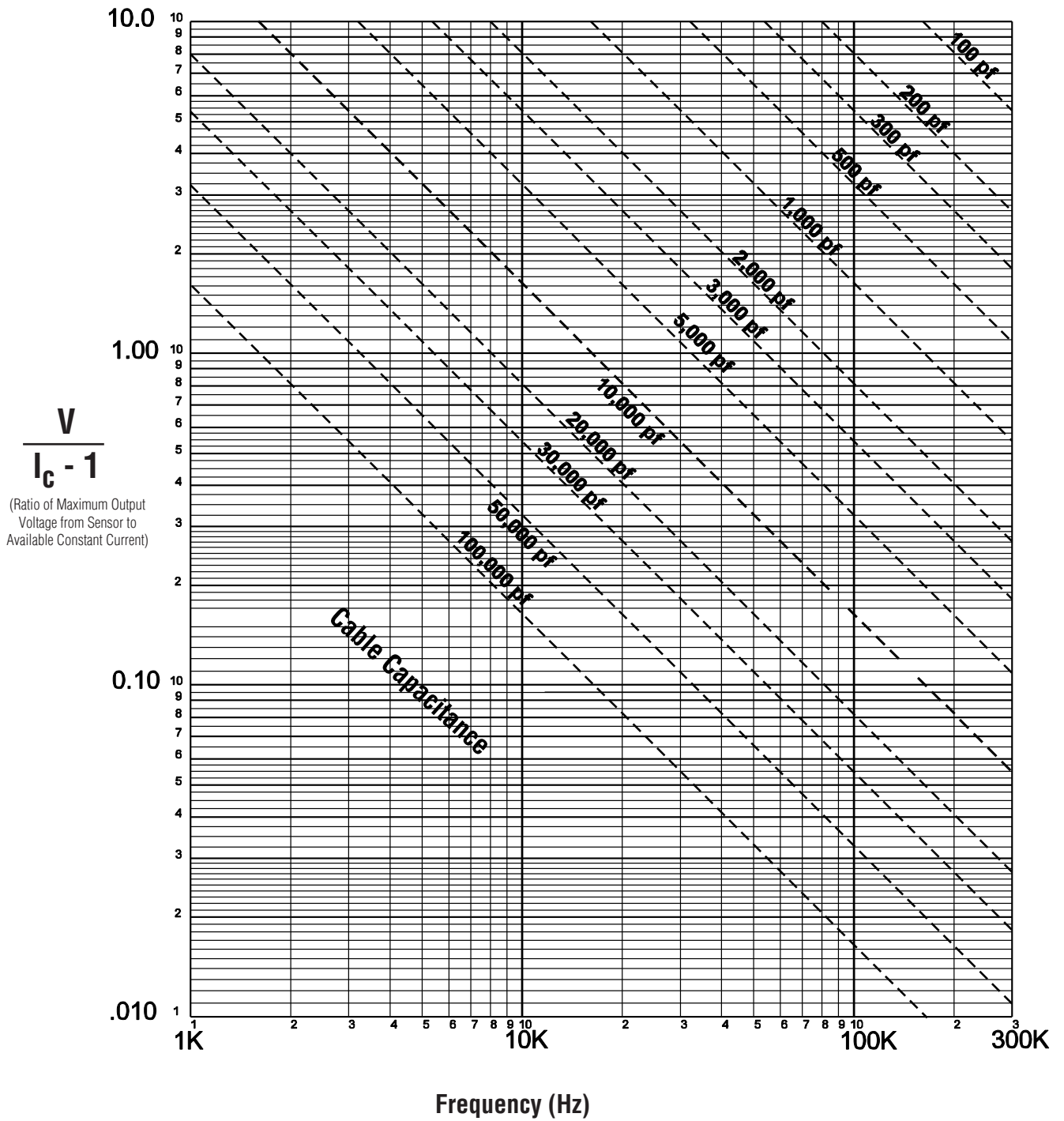

Figure 12. Testing Long Cables

Introduction to Piezoelectric Sensors



$$f_{\max} = \frac{10^9}{2\pi CV / (I_c - 1)}$$

f_{\max} = Maximum frequency (Hz)

C = Cable capacitance (pF)

V = Maximum output voltage from sensor (volts)

I_c = Constant current level from power unit (mA)

10^9 = Scale factor to equate units

Figure 13. Cable Driving Nomograph

Introduction to Piezoelectric Sensors

The alternate test method, also shown in **Figure 12**, incorporates a sensor simulator which contains a signal generator and sensor electronics conveniently packaged together.

In order to check the frequency/amplitude response with either of these systems, set the signal generator to supply the maximum amplitude of the expected measurement signal. Observe the ratio of the amplitude from the generator to that shown on the scope. If this ratio is 1:1, the system is adequate for your test. (If necessary, be certain to factor in any gain in the signal conditioner or scope.) If the output signal is rising (e.g., 1:1.3), add series resistance to attenuate the signal. Use of a variable 100 ohm resistor will help set the correct resistance more conveniently. Note that this is the only condition that requires the addition of resistance. If the signal is falling (e.g., 1:0.75), the constant current level must be increased or the cable capacitance reduced.

It may be necessary to physically install the cable during cable testing to reflect the actual conditions encountered during data acquisition. This will compensate for potential inductive cable effects that are partially a function of the geometry of the cable route.

low-output impedance (<5 ohm) instrumentation amplifier in series with the ICP® sensor. The extremely low-output impedance is required to minimize the resistance change when the signal generator and amplifier are removed from the system. The alternate test method, also shown in **Figure 12**, incorporates a sensor simulator which contains a signal generator and sensor electronics conveniently packaged together.

In order to check the frequency/amplitude response with either of these systems, set the signal generator to supply the maximum amplitude of the expected measurement signal. Observe the ratio of the amplitude from the generator to that shown on the scope. If this ratio is 1:1, the system is adequate for your test. (If necessary, be certain to factor in any gain in the signal conditioner or scope.) If the output signal is rising (e.g., 1:1.3), add series resistance to attenuate the signal. Use of a variable 100 ohm resistor will help set the correct resistance more conveniently. Note that this is the only condition that requires the addition of resistance. If the signal is falling (e.g., 1:0.75), the constant current level must be increased or the cable capacitance reduced.

It may be necessary to physically install the cable during cable testing to reflect the actual conditions encountered during data acquisition. This will compensate for potential inductive cable effects that are partially a function of the geometry of the cable route.

Low Frequency Response of ICP® Sensors

With ICP® sensors, there are two factors which must be considered when acquiring low-frequency information. These are:

- 1 The discharge time constant characteristic of a sensor (a fixed value unique to each sensor).

- 2 The time constant of the coupling circuit used in the signal conditioner. (If DC coupling is used, only #1 needs to be considered).

It is important that both factors are readily understood by the user to avoid potential problems.

Transducer Discharge Time Constant

The discharge time constant is the more important of the low frequency limits, because it is the one over which the user has no control.

Consider the ICP® sensors shown previously in **Figure 6**. While the sensing element will vary widely in physical configuration for the various types (and ranges) of pressure, force, and acceleration sensors, the basic theory of operation is similar for all. The sensing element, when acted upon by a step function measurand (pressure, force or acceleration) at $t = t_0$, produces a quantity of charge, Δq , linearly proportional to this mechanical input.

In quartz ICP® sensors, this charge accumulates in the total capacitance, C_{total} , which includes the capacitance of the sensing element, plus amplifier input capacitance, ranging capacitor and any additional stray capacitance. (Note: A ranging capacitor, which would be in parallel with the resistor, is used to reduce the voltage sensitivity and is not shown.) The result is a voltage according to the law of electrostatics: $\Delta V = \Delta q / C_{total}$. This voltage is then amplified by a MOSFET voltage amplifier to determine the final sensitivity of the sensor. From this equation, the smaller the capacitance, the larger the voltage sensitivity. While this is true, there is a practical limit where a lower capacitance will not significantly increase the signal-to-noise ratio.

In ceramic ICP® sensors, the charge from the crystal is typically used directly by an integrated charge amplifier. In this case, only the feedback capacitor (located between the input and output of the amplifier) determines the voltage output, and consequently the sensitivity of the sensor.

While the principle of operation is slightly different for quartz and ceramic sensors, the schematics (**Figure 6**) indicate that both types of sensors are essentially resistor-capacitor (RC) circuits.

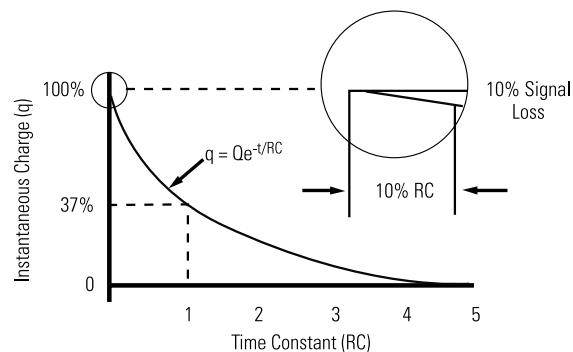

Figure 14. Characteristic Discharge Curve

Introduction to Piezoelectric Sensors

After a step input, the charge immediately begins dissipating through resistor (R) and follows the basic RC discharge curve of equation:

$$q = Qe^{-t/RC} \quad \text{(Equation 8)}$$

Where: q = instantaneous charge (pC)
 Q = initial quantity of charge (pC)
 R = bias (or feedback) resistor value (ohms)
 C = total (or feedback) capacitance (pF)
 t = any time after t_0 (sec)
 e = base of natural log (2.718)

This equation is graphically illustrated in **Figure 14**. Note that the output voltage signal from an ICP® sensor will not be zero-based as shown below, but rather based on an 8 to 10 VDC amplifier bias.

The product of R times C is the discharge time constant (DTC) of the sensor (in seconds) and is specified in the calibration information supplied with each ICP® sensor. Since the capacitance fixes the gain and is constant for a particular sensor, the resistor is used to set the time constant. Typical values for a discharge time constant range from less than one second to up to 2000 seconds.

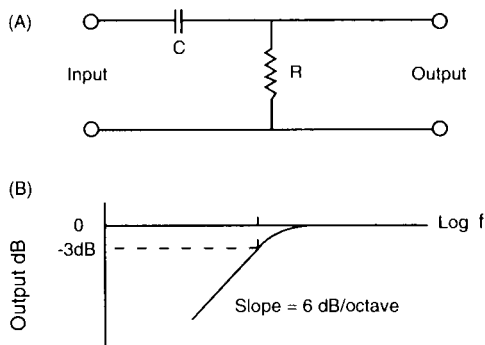

Figure 15. Transfer Characteristics of an ICP® Sensor

Effect of DTC on Low-frequency Response

The discharge time constant of an ICP® sensor establishes the low-frequency response analogous to the action of a first order, high-pass, RC filter as shown in **Figure 15A**. **Figure 15B** is a Bode plot of the low-frequency response.

This filtering characteristic is useful for draining off low-frequency signals generated by thermal effects on the transduction mechanism. If allowed to pass, this could cause drifting, or in severe cases, saturate the amplifier.

The theoretical lower corner or frequency (f_0), is determined by the following relationships, where DTC equals the sensor discharge time constant in seconds. See **Table 1**.

$$3\text{dB down: } f_0 = 0.16 / (\text{DTC}) \quad \text{(Equation 9)}$$

$$10\% \text{ down: } f_0 = 0.34 / (\text{DTC}) \quad \text{(Equation 10)}$$

$$5\% \text{ down: } f_0 = 0.5 / (\text{DTC}) \quad \text{(Equation 11)}$$

DTC (sec)	Frequency (Hz)		
	-5%	-10%	-3 dB
.1	5	3.4	1.6
.5	1	.68	.32
1	.5	.34	.16
5	.1	.07	.03
10	.05	.03	.016

Table 1. Low-frequency Response Table

Effect of DTC on Long Duration Time Waveforms

Often it is desirable to measure step functions or square waves of various measurands lasting several per cent of the sensor time constant, especially when statically calibrating pressure and force sensors.

The following is an important guide to this type of measurement: the amount of output signal lost and the elapsed time as a percent of the DTC, have a

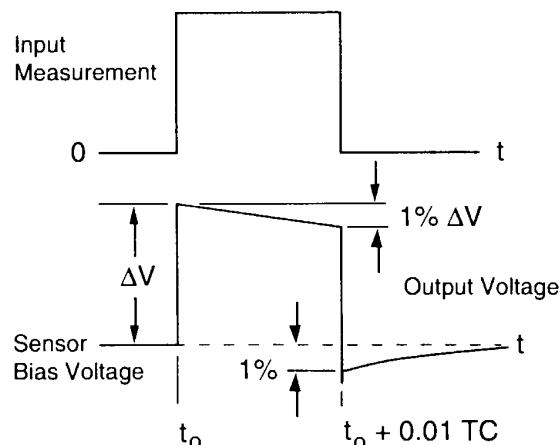

Figure 16. Step Function Response

one-to-one correspondence up to approximately 10% of the DTC. **Figure 16** shows the output voltage vs. time with a square wave input. (For accurate readings, DC couple the signal conditioner and readout instrument.)

At time $t = t_0$ a step measurand (psi or lb.) is applied to the sensor and allowed to remain for 1% of the DTC at which time it is abruptly removed. The output voltage change ΔV , corresponding to this input is immediately added to the sensor bias voltage and begins to discharge at $t > t_0$. When $t = t_0 + (0.01 \text{ DTC})$, the signal level has decreased by 1% of ΔV . This relationship is linear to only approximately 10% of the DTC. (i.e., If the measurand is removed at $t = 0.1 \text{ DTC}$, the output signal will have discharged by approximately 10% of ΔV .)

After 1 DTC, 63% of the signal will have discharged. After 5 DTCs, the output signal has essentially discharged and only the sensor bias voltage level remains.

Introduction to Piezoelectric Sensors

Upon removal of the measurand, the output signal will dip below the sensor bias voltage by the same amount that it has discharged. Then, it will charge toward the sensor bias voltage level until reaching a steady state.

For a minimum 1% measurement accuracy, the discharge time constant should be at least 100 times the duration of a square wave event, 50 times the duration of a half ramp and 25 times the duration for a half sine pulse. Longer time constants will improve measurement accuracy.

Effect of Coupling on Low-frequency Response

As previously mentioned, if the constant current signal conditioner (shown in **Figure 5**) is DC-coupled, the low-frequency response of the system is determined only by the sensor DTC. However, since many signal conditioners are AC-coupled, the total coupling DTC may be the limiting factor for low frequency measurements.

For example, **Figure 7** illustrates typical AC-coupling through a 10 μF coupling capacitor (built into many constant current signal conditioners.) Assuming a 1 megohm input impedance on the readout instrument (not shown), the coupling time constant simply equals R times C, or 10 seconds. (This also assumes a sensor output impedance of <100 ohms.) As a general rule, keep the coupling time constant at least 10 times larger than the sensor time constant.

When acquiring low-frequency measurements, low-input impedance tape recorders and other instruments will reduce the coupling time constant significantly. For such cases, use a signal conditioner which incorporates DC-coupling or a buffered output.

Methods of DC Coupling

To take full advantage of the sensor DTC, especially during static calibration, it is often essential to DC-couple the output signal. The simplest method is to use a signal conditioner which incorporates a DC-coupling switch. However, standard signal conditioners may also be adapted for DC-coupling by using a "T" connector, as in **Figure 17**.

The important thing to keep in mind is that the readout instrument must have a zero offset capability to remove the sensor bias voltage. If the readout is unable

to remove all or a portion of the bias voltage, a current limited "bucking" battery or variable DC power supply, placed in-line with the signal, may be used to accomplish this task. It is imperative that any opposing voltage be current-limited, to avoid potential damage to the sensor's built-in circuitry.

For convenience, several constant current signal conditioners manufactured by PCB incorporate level shifting circuits to allow DC-coupling with zero volts output bias. Most of these units also feature an AC-coupling mode for drift-free dynamic operation.

Cautions

These precautionary measures should be followed to reduce risk of damage or failure in ICP® sensors:

- 1 Do not apply more than 20 mA constant current to ICP® sensors or in-line amplifiers.
- 2 Do not exceed 30 VDC supply voltage.
- 3 Do not apply voltage without constant current protection. Constant current is required for proper operation of ICP® sensors.
- 4 Do not subject standard ICP® sensors to temperatures above 250 °F (121 °C). Consult a PCB Applications Engineer to discuss testing requirements in higher temperature environments.
- 5 Most ICP® sensors have an all-welded hermetic housing. However, due to certain design parameters, certain models are epoxy sealed. In such cases, high humidity or moist environments may contaminate the internal electronics. In such cases, bake the sensors at 250 °F (121 °C) for one or two hours to evaporate any contaminants.
- 6 Many ICP® sensors are not shock-protected. For this reason, care must be taken to ensure the amplifier is not damaged due to high mechanical shocks. Handle such sensors with care, so as not to exceed the maximum shock limit indicated on the specification sheet.

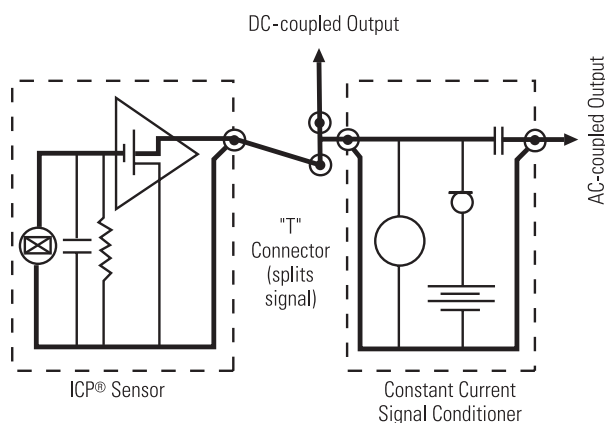

Figure 17. Adapted DC-coupled Sensing System

Technical Information-Accelerometers

Introduction to Accelerometers

Accelerometers are sensing transducers that produce an electrical output signal proportional to the acceleration aspect of motion, vibration, and shock. Some accelerometers also measure the uniform acceleration aspect of earth's gravitational effect. Most accelerometers generate an electrical output signal that is proportional to an induced force. This force is proportional to acceleration, according to Newton's law of motion, $F=ma$, where "F" is the induced and subsequently measured force, "m" is the mass creating the force, and "a" is acceleration. Acceleration measurements are quite useful for a wide variety of applications due to this proportionality to force, one of science's truly fundamental, physical measurement parameters.

Types of Accelerometers Offered by PCB

PCB designs and manufactures accelerometers that utilize either piezoelectric or MEMS sensing technology. Piezoelectric accelerometers rely on the self-generating, piezoelectric effect of either quartz crystals or ceramic materials to produce an electrical output signal proportional to acceleration. Many such accelerometers contain built-in signal conditioning circuitry and are known as voltage mode, low-impedance, Integrated Electronic Piezoelectric (IEPE) or Integrated Circuit - Piezoelectric (PCB's trademarked name, "ICP®") sensors. Piezoelectric accelerometers that do not contain any additional circuitry are known as charge output or high-impedance sensors. Piezoelectric accelerometers are capable of measuring very fast acceleration transients such as those encountered with machinery vibration and high-frequency shock measurements. Although they can respond to slow, low-frequency phenomenon, such as the vibration of a bridge, piezoelectric accelerometers cannot measure truly uniform acceleration, also known as static or DC acceleration. MEMS accelerometers sense a change in electrical capacitance, with respect to acceleration, to vary the output of an energized circuit. MEMS accelerometers are capable of uniform acceleration measurements, such as the gravitational effect of the earth. They can also respond to varying acceleration events but with limitation to low frequencies of up to 1-2 kHz (Depending upon sensitivity).

Function of Piezoelectric Accelerometers

As stated above, piezoelectric accelerometers rely on the self-generating, piezoelectric effect of either quartz crystals or ceramic materials to produce an electrical output signal proportional to acceleration. The piezoelectric effect is that which causes a realignment and accumulation of positively and negatively charged electrical particles, or ions, at the opposed surfaces of a crystal lattice, when that lattice undergoes stress. The number of ions that accumulate is directly proportional to the amplitude of the imposed stress or force. The piezoelectric effect is depicted in the following figure of a quartz crystal lattice.

In the creation an accelerometer, it is necessary that the stress imposed upon the piezoelectric material be the direct result of the device undergoing an acceleration. To accomplish this, a mass is attached to the crystal which, when accelerated, causes force to act upon the crystal. The mass, also known as a

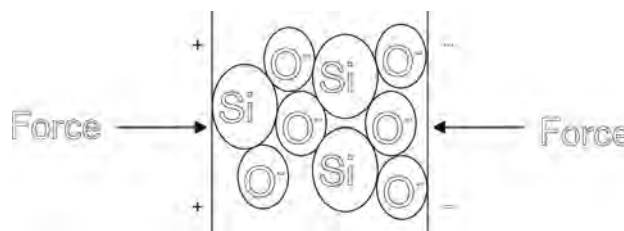

Figure 18. Piezoelectric Effect of a Quartz Crystal Lattice

seismic mass, creates a force directly proportional to acceleration according to Newton's law of motion, $F=ma$. Thin metallic electrodes, typically made of gold foil, serve to collect the accumulated ions. Small lead wires interconnect the electrodes to an electrical connector or feed-through, to which signal transmission cabling is attached. Piezoelectric accelerometer signals generally require conditioning before being connected to readout, recording, or analysis equipment. This signal conditioning is either remotely located or built into the accelerometer.

Piezoelectric Sensing Materials

Two categories of piezoelectric material predominantly used in accelerometer designs are quartz and polycrystalline ceramics. Quartz is a naturally occurring crystal; however, the quartz used in sensors today is produced by a process that creates material free from impurities. Ceramic materials, on the other hand, are manmade. Different specific ingredients yield ceramic materials that possess certain desired sensor properties. Each material offers distinct benefits, and material choice depends on the particular performance features desired of the accelerometer.

Quartz

Quartz is widely known for its ability to perform accurate measurement tasks and contributes heavily in everyday applications for time and frequency measurements, such as wrist watches, radios, computers, and home appliances. Accelerometers also benefit from several unique characteristics of quartz. Since quartz is naturally piezoelectric, it has no tendency to relax to an alternative state and is considered the most stable of all piezoelectric materials. Quartz-based sensors, therefore, make consistent, repeatable measurements and continue to do so over long periods of time. Also, quartz has no output occurring from temperature fluctuations, a formidable advantage when placing sensors in thermally active environments. Because quartz has a low capacitance value, the voltage sensitivity is relatively high compared to most ceramic materials, making it ideal for use in voltage-amplified systems. Conversely, the charge sensitivity of quartz is low, limiting its usefulness in charge-amplified systems, where low noise is an inherent feature.

Technical Information-Accelerometers

Ceramics

A wide variety of ceramic materials are used for accelerometers, and which material to use depends on the requirements of the particular application. All ceramic materials are manmade and are forced to become piezoelectric by a polarization process. This process, known as "poling," exposes the material to a high-intensity electrical field, which aligns the electric dipoles, causing the material to become piezoelectric. If ceramic is exposed to temperatures exceeding its range or to electric fields approaching the poling voltage, the piezoelectric properties may be drastically altered or destroyed. Accumulation of high levels of static charge also can have this effect on the piezoelectric output.

Differences in ceramics utilized determine such factors as charge sensitivity, voltage sensitivity, and temperature range. High charge output ceramics may be mated with built-in charge amplifier circuits to achieve high output signals, high resolution, and an excellent signal to noise ratio. Certain high-temperature ceramics are used for charge mode accelerometers — some with temperature ranges to 900 °F (482 °C).

Structures for Piezoelectric Accelerometers

A variety of mechanical structures are available to perform the transduction principles required of a piezoelectric accelerometer. These configurations are defined by the nature in which the inertial force of an accelerated mass acts upon the piezoelectric material. Such terms as compression mode, flexural mode and shear mode describe the nature of the stress acting upon the piezoelectric material. Current designs of PCB accelerometers utilize, almost exclusively, the shear mode of operation for their sensing elements. Therefore, the information provided herein is limited to that pertaining to shear mode accelerometers.

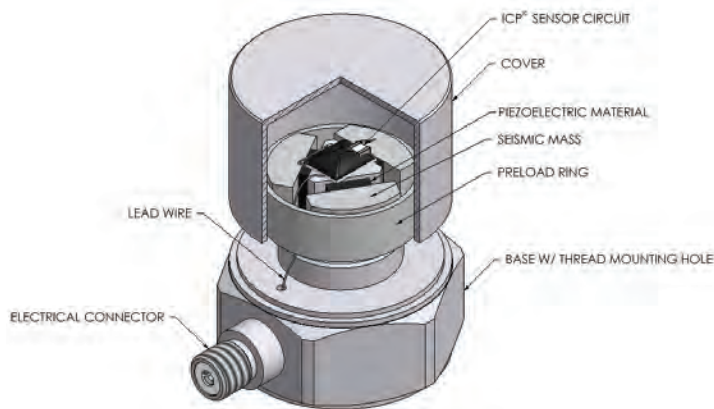

Figure 19. Shear Mode Accelerometer

Shear Mode

Shear mode accelerometer designs feature sensing crystals attached between a center post and a seismic mass. A compression ring or stud applies a pre-load force to the element assembly to insure a rigid structure and linear behavior. Under acceleration, the mass causes a shear stress to be applied to the sensing crystals. This stress results in a proportional electrical output by the piezoelectric

material. The output is collected by electrodes and transmitted by lightweight lead wires to either the built-in signal conditioning circuitry of ICP® sensors, or directly to the electrical connector for charge mode types. By having the sensing crystals isolated from the base and housing, shear mode accelerometers excel in rejecting thermal transient and base-bending effects. Also, the shear geometry lends itself to small size, which promotes high frequency response while minimizing mass loading effects on the test structure. With this combination of ideal characteristics, shear mode accelerometers offer optimum performance.

Function & Structure of MEMS DC Accelerometers

PCB® MEMS DC Accelerometers achieve true DC Response for measuring uniform (or constant) acceleration and low frequency vibration. The sensor element features a proof mass, ring frame, and attachment system between the two. These features are bulk micro machined from the same single-crystal silicon wafer. The movement of the proof mass is directly affected by acceleration applied in the axis of sensitivity.

The sensor element is connected as a bridge element in the circuit. The electrical characteristics of one portion of the bridge, increases in value, while the other decreases when exposed to acceleration. This approach minimizes common mode errors and improves non-linearity.

A wafer containing the proof mass and ring frame is laminated between two wafers using a glass bond. This provides a hermetic enclosure for the proof mass in dry nitrogen after singulation, as well as mechanical isolation and protection.

A selection of full scale measurement ranges are attained by modifying the stiffness of the suspension system of the proof mass. A high natural frequency is accomplished through the combination of a lightweight proof mass and suspension stiffness.

Ruggedness is enhanced through the use of mechanical stops on the two outer wafers to restrict the travel of the proof mass. Damping is used to mitigate high frequency inputs.

The sensor elements use squeeze-film gas damping that is nominally 0.7 critical. This is the result of the movement of the proof mass pressing on the gas in the gap between it and the outer sensor layer. Damping helps prevent the output of the accelerometer from becoming saturated, as would happen when the resonance of an accelerometer with no damping is excited by random vibration. The advantage of gas damping over liquid damping is that it is minimally affected by temperature changes.

All units contain conditioning circuitry that provides a high sensitivity output. This IC also provides compensation of zero bias and sensitivity errors over temperature using a continuous piecewise straight line correction engine.

Technical Information-Accelerometers

Function & Structure of MEMS DC Accelerometers con't

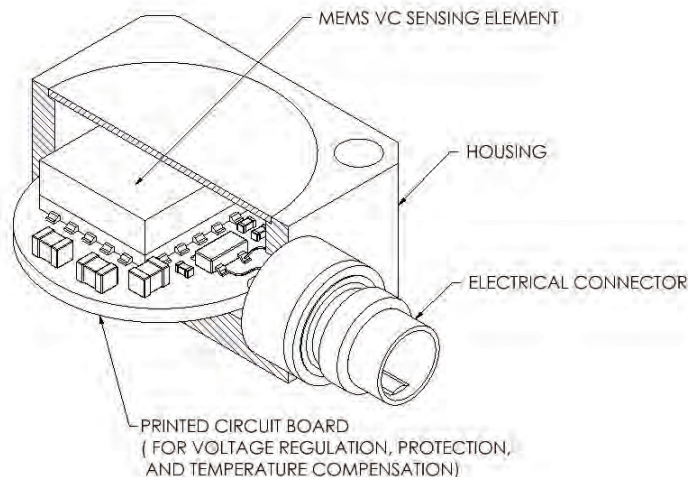

Figure 20. MEMS DC Accelerometer

PCB® Series 3711 (Uniaxial) & Series 3713 (Triaxial) units provide a single-ended output signal and include an on-board voltage regulator with excitation range of 6 to 30 VDC and 5 mA current draw. Both series feature a +/- 2V full scale zero based output referenced to power ground.

PCB® Series 3741 (Uniaxial) units provide a differential output signal for common mode noise rejection. An on-board voltage regulator allows an excitation range of 6 to 30 VDC and 5 mA current draw. The positive output signal line increases with acceleration while the negative line decreases proportionally. The output lines have a common mode voltage of +2.5 VDC above circuit ground.

Accelerometer Mounting Considerations

Frequency Response

One of the most important considerations in dealing with accelerometer mounting is the effect the mounting technique has on the accuracy of the usable frequency response. The accelerometer's operating frequency range is determined, in most cases, by securely stud mounting the test sensor directly to the reference standard accelerometer. The direct, stud mounted coupling to a very smooth surface generally yields the highest mounted resonant frequency and therefore, the broadest usable frequency range. The addition of any mass to the accelerometer, such as an adhesive or magnetic mounting base, lowers the resonant frequency of the sensing system and may affect the accuracy and limits of the accelerometer's usable frequency range. Also, compliant materials, such as a rubber interface pad, can create a mechanical filtering effect by isolating and damping high-frequency transmissibility.

Surface Preparation

For best measurement results, especially at high frequencies, it is important to prepare a smooth and flat machined surface where the accelerometer is to be attached. Inspect the area to ensure that no metal burrs or other foreign particles interfere with the contacting surfaces. The application of a thin layer of silicone

grease between the accelerometer base and the mounting surface also assists in achieving a high degree of intimate surface contact required for best high-frequency transmissibility.

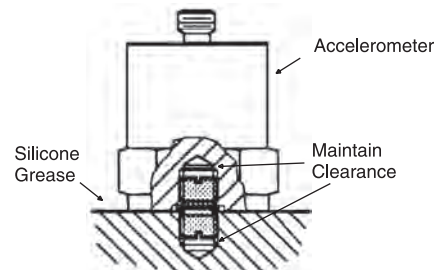

Figure 21. Stud Mounted Accelerometer

Stud Mounting

For permanent installations, where a very secure attachment of the accelerometer to the test structure is preferred, stud mounting is recommended. First, grind or machine on the test object a smooth, flat area at least the size of the sensor base, according to the manufacturer's specifications. Then, prepare a tapped hole in accordance with the supplied installation drawing, ensuring that the hole is perpendicular to the mounting surface. Install accelerometers with the mounting stud and make certain that the stud does not bottom in either the mounting surface or accelerometer base. Most PCB mounting studs have depth-limiting shoulders that ensure that the stud cannot bottom-out into the accelerometer's base. Each base incorporates a counterbore so that the accelerometer does not rest on the shoulder. Acceleration is transmitted from the structure's surface into the accelerometer's base. Any stud bottoming or interfering between the accelerometer base and the structure inhibits acceleration transmission and effects measurement accuracy. When tightening, apply only the recommended torque to the accelerometer. A thread-locking compound may be applied to the threads of the mounting stud to safeguard against loosening.

Screw Mounting

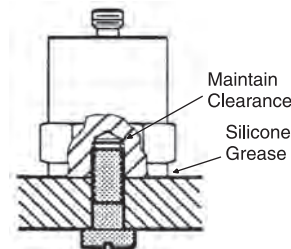

Figure 22. Screw Mounted Accelerometer

When installing accelerometers onto thin-walled structures, a cap screw passing through a hole of sufficient diameter is an acceptable means for securing the accelerometer to the structure. The screw engagement length should always be checked to ensure that the screw does not bottom into the accelerometer base. A thin layer of silicone grease at the mounting interface ensures high-frequency transmissibility.

Technical Information-Accelerometers

Adhesive Mounting

Mounting by stud or screw may not always be practical. For such cases, adhesive mounting offers an alternative mounting method. The use of separate adhesive mounting bases is recommended to prevent the adhesive from damaging the accelerometer base or clogging the mounting threads miniature accelerometers are provided with the integral stud removed to form a flat base). Most adhesive mounting bases available from PCB also provide electrical isolation, which eliminates potential noise pick-up and ground loop problems. The type of adhesive recommended depends on the particular application. Petro Wax (available from PCB) offers a very convenient, easily removable approach for room temperature use. Two-part epoxies offer stiffness, which maintains high-frequency response and a permanent mount. Other adhesives, such as dental cement, hot glues, instant glues, and duct putty are also viable options with a history of success.

There is no one "best" adhesive for all applications because of the many different structural and environmental considerations, such as temporary or permanent mount, temperature, type of surface finish, and so forth.

To avoid damaging the accelerometer, a debonding agent must be applied to the adhesive prior to sensor removal. With so many adhesives in use (everything from super glues, dental cement, epoxies, etc), there is no universal debonding agent available. The debonder for the Loctite 454 adhesive that PCB® Suggests is Acetone. If you are using anything other than Loctite 454, you will have to check with the individual manufactures for their debonding recommendations. The debonding agent must be allowed to penetrate the surface in order to properly react with the adhesive, so it is advisable to wait a few minutes before removing the sensor.

After the debonding agent has set, you can use an ordinary open-end wrench if the accelerometer has a hex base or square base, or the supplied removal tool for teardrop accelerometers. After attaching either, use a gentle shear (or twisting) motion (by hand only) to remove the sensor from the test structure.

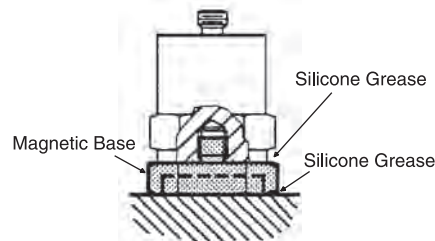

Figure 23. Magnet Mounted Directly to Test Structure

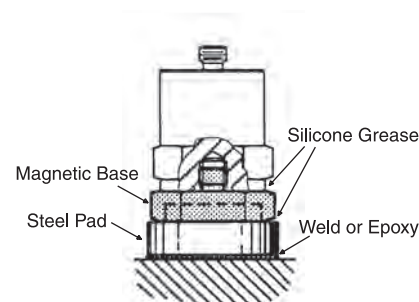

Figure 24. Magnet Mounted to Steel Pad

Magnetic Mounting

Magnetic mounting bases offer a very convenient, temporary attachment to magnetic surfaces. Magnets offering high pull strengths provide best high-frequency response. Wedged dual-rail magnetic bases are generally used for installations on curved surfaces, such as motor and compressor housings and pipes. However, dual-rail magnets usually significantly decrease the operational frequency range of an accelerometer. For best results, the magnetic base should be attached to a smooth, flat surface. A thin layer of silicone grease should be applied between the sensor and magnetic base, as well as between the magnetic base and the structure. When surfaces are uneven or non-magnetic, steel pads can be welded or epoxied in place to accept the magnetic base.

Caution: Magnetically mounting an accelerometer has the potential to generate very high and very damaging acceleration levels. To prevent such damage, exercise caution when attaching to your test structure and gently "rock" or "slide" the assembly in place. Do not allow the magnet to "snap" on to the test structure. Another more ideal method is to attach the magnetic base to your test structure first, and then screw the accelerometer on to the magnetic base.



Technical Information-Microphones

Introduction to Microphones

High precision microphones are used in acoustical test and measurement applications to determine the sound pressure, in decibels (dB), that is exerted on an object at different frequencies and wavelengths. Acoustic testing is performed for a variety of applications, including new product design, product monitoring, predictive maintenance, and personal protection. Pressure from sound not only can damage material items, but also can damage the most precious and delicate design created to perceive it, the human ear.

Condenser Microphone

A condenser microphone is constructed by forming a capacitor between a thin, flexible diaphragm and a back plate. As sound pressure levels approach the diaphragm, it causes the diaphragm to deflect. The distance that the diaphragm moves, in relationship to the back plate, will cause a change in the capacitance. The capacitance change is then detected electrically. In order to measure the capacitance, a charge must be applied to the cartridge. In traditional microphones, a DC polarization voltage is supplied by an external power supply. In the modern (prepolarized) designs, a polymer (called an electret), contains its own internal polarization. The electret contains frozen electrical charges, which are stimulated by low-cost, ICP® constant current supply (2 - 20 mA). A voltage can then be measured and output from the changes in capacitance. Programs in external devices can then convert this output into sound pressure levels in decibels.

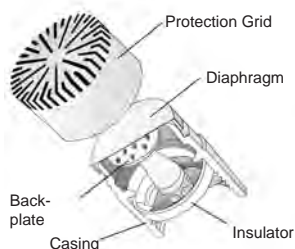

Figure 25. Cutaway Drawing of a Precision Microphone

Microphones Field Types Offered by PCB

PCB offers the three most common microphone types used for testing; free-field, pressure, and random incident. A free-field microphone is designed to be most accurate when measuring sound radiating from a single source, pointing directly at the microphone. The sound waves propagate freely, with no objects present which may disturb or influence the sound field. The free-field microphone measures the sound pressure as it exits from the sound source, without the influence of the microphone itself. These microphones work best in open areas, where there is no hard or reflective surfaces, such as anechoic rooms.

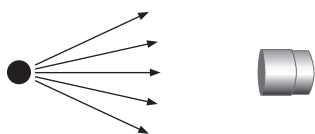

Figure 26. Sound Field Measured by a Free-Field Microphone

A pressure field microphone is designed to measure the sound pressure that exists in front of the diaphragm. It is described to have the same magnitude and phase at any position in the field. It is usually found in an enclosure, or cavity, which is small when compared to wavelength. The microphone will include the measurement changes in the sound field caused by the presence of the microphone. The sound being measured is coming from one source at a direction pointing directly at the microphone. Testing of pressure exerted on walls, structures, or pressure exerted on airplane wings are examples of pressure field microphone applications.

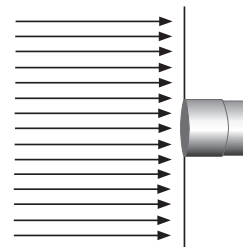

Figure 27. Sound Field Measured by a Pressure Microphone

A random incident microphone, also referred to as a “diffuse field” type, is designed to be omni-directional and measure sound pressure coming from multiple directions. The random incident microphone will measure the sound as if it existed before the introduction of the microphone itself into the diffuse field. When taking sound measurements in a church or in a shop with hard, reflective walls, you would utilize this type of microphone.

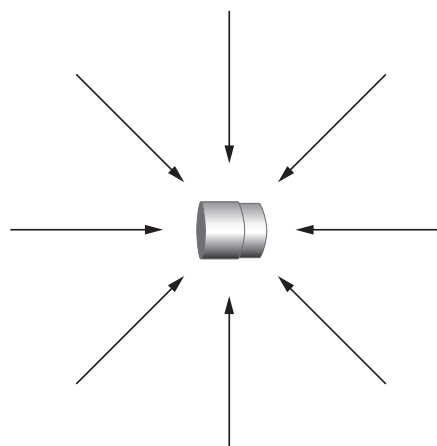

Figure 28. Sound Field Measured by a Random Incident Microphone

Dynamic Response

Sound pressure level is typically measured in Pascals (Pa). The lowest amplitude that a normal healthy human ear can detect is 20 millionths of a Pascal (20mPa). Since the pressure numbers represented by Pascals are generally very low and not easily managed, another scale was developed and is more commonly used, called the Decibel (dB). The decibel scale is logarithmic and more closely matches the response reactions of the human ear to the pressure fluctuations.

Technical Information-Microphones

Table 2. Sound Pressure Level References

0 dB = 0.00002 Pa	Threshold of Hearing
60 dB = 0.02 Pa	Business Office
80 dB = 0.2 Pa	Shop Noise
94 dB = 1 Pa	Large Truck
100 dB = 2 Pa	Jackhammer
120 dB = 20 Pa	Airplane Take-Off
140 dB = 200 Pa	Threshold of Pain

PCB specifies the maximum dynamic range of its microphone cartridges based on allowable harmonic distortion levels and the design and physical characteristics of the microphone. The specified maximum dB level will refer to the point where the diaphragm will approach the backplate. The maximum decibels that a microphone will output in a certain application is dependent upon the voltage supplied, and the particular microphone's sensitivity. In order to calculate the maximum output for a microphone, using a specific preamplifier and its corresponding peak voltage, use the following formulas:

$$\text{Pressure (Pa)} = \frac{\text{Voltage (V)}}{\text{Sensitivity (mV/Pa)}}$$

$$\text{dB} = 20 \log (P/P_0)$$

(Equation 12)

P = Pressure in Pascals (Pa)

P₀ = Reference Pressure (0.00002 Pa)

Formulas for determining maximum microphone output

**Acoustic Measurement Systems-
Condenser Microphones**

There are two types of precision condenser microphones offered by PCB; externally polarized and prepolarized. The cartridge from a condenser microphone operates on basic transduction principles. It transforms the sound pressure into capacitance variations, which are then converted to an electrical signal. This conversion process requires a constant electrical charge (polarization voltage), which is either applied by a power supply or built into the microphone. Externally Polarized microphones will differ, when compared to the Prepolarized microphones, in the relationship of how the constant charge of the capacitance between the diaphragm and backplate is applied. Externally Polarized and Prepolarized microphones will each require different components for optimum operation.

Externally polarized microphones are based on a capacitive transduction principle. These high precision condenser microphones require a constant electrical charge for polarization from an external source. This voltage source comes from an external power supply, which ranges from 0V (and can be used with Prepolarized microphones) to 200V. PCB's Externally Polarized microphone set-up requires the use of 7-conductor cabling. Externally polarized microphones are the traditional design, and are still utilized for compatibility reasons.

Prepolarized microphones are also high precision condenser type microphones. The polarization process is accomplished by adding a polymer that is applied to the backplate. This permanently charged polymer contains frozen electrical charges and is commonly referred to as an electret. The prepolarized microphones can be powered by inexpensive and easy-to-operate ICP® sensor power supplies (constant current signal conditioners) or directly powered by a readout device that has constant current power built-in. This enables the owner to use low impedance coaxial cables with BNC or 10-32 microdot connectors (rather than

7 Pin conductor cabling), for both current supply and signal to the readout device. This newer design has become very popular in recent years due to its cost savings and ease of use characteristics.

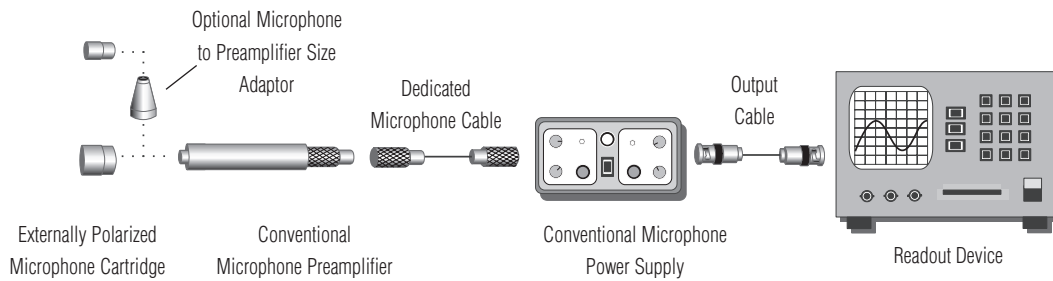

Figure 29. Externally Polarized Microphone System

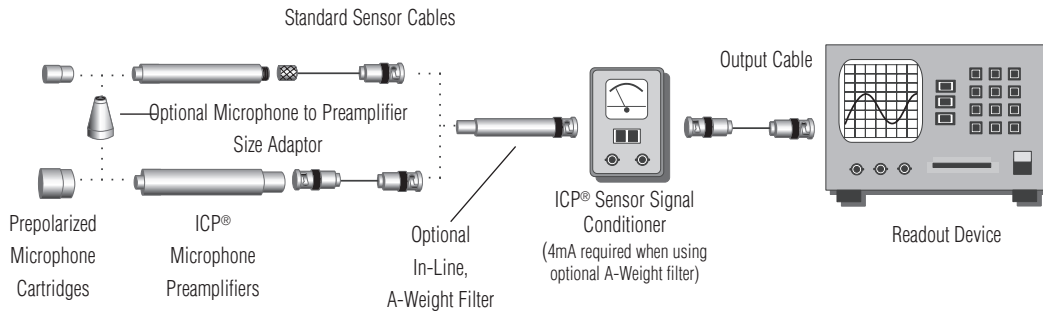

Figure 30. Prepolarized Microphone System

Technical Information-Microphones

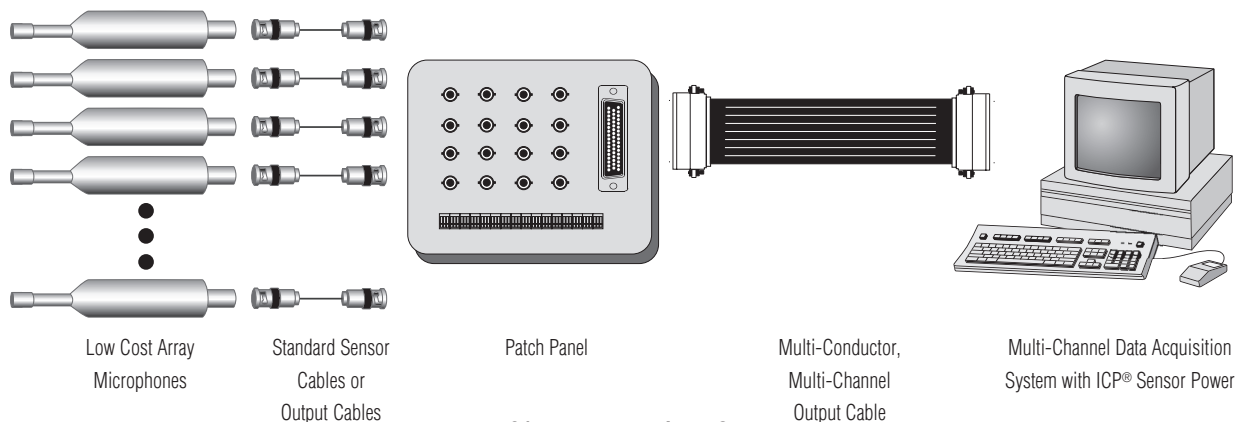

Figure 31. Array Microphone System

Acoustic Measurement Systems – Array Microphones

Array microphones are also a Prepolarized design with a free-field response. They are specifically designed to offer a cost effective solution for multiple channel sound pressure measurements. Units are often arranged in a 2D Grid and used for applications such as Sound Pressure Mapping, Beamforming, or Holography. By taking a number of Array microphones and spacing them out in a predetermined pattern, users then have the ability to take the output into software and transform a complex sound pressure field into a map of the acoustic energy flow.

PCB® 130E Series of array microphones have an integral preamplifier, and can be directly powered from any ICP® power source. In addition each unit is TEDS compliant, (IEEE 1451.4) which when attached to a corresponding TEDS-capable ICP® Signal Conditioner provides a self-identification of the sensors calibration information.

As with all inexpensive alternatives, the 130E Series array microphones also have some limitations, (as compared to our 377 Series of Condenser Microphones). Specifically they have a reduced frequency response, (20 Hz. to 10,000 Hz. +/-2 dB). In addition they are more sensitive to changes in voltage sensitivity due to varying temperature or humidity. PCB model CAL 250 provides a simple method of verifying actual voltage sensitivity prior to performing each test.



Technical Information-Pressure

Introduction to Dynamic Pressure Sensors

Piezoelectric Pressure Sensors measure dynamic pressures. They are generally not suited for static pressure measurements. Dynamic pressure measurements including turbulence, blast, ballistics and engine combustion under varying conditions may require sensors with special capabilities. Fast response, ruggedness, high stiffness, extended ranges, and the ability to also measure quasi-static pressures are standard features associated with PCB quartz pressure sensors.

The following information presents some of the design and operating characteristics of PCB pressure sensors to help you better understand how they function, which, in turn, helps you make better dynamic measurements.

Types of Pressure Sensors

This catalog describes two modes of operation for pressure sensors manufactured by PCB. Charge mode pressure sensors generate a high-impedance charge output. ICP® (Integrated Circuit Piezoelectric) voltage mode-type sensors feature built-in microelectronic amplifiers, which convert the high-impedance charge into a low-impedance voltage output. (ICP is a registered trademark of PCB Piezotronics, Inc. Inc.)

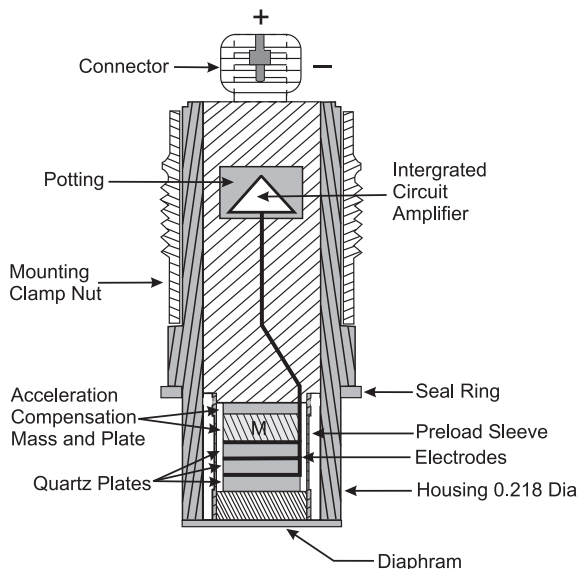

Figure 32. Typical ICP Quartz Pressure Sensor

Figure 32. Illustrates the cross-section of a typical quartz pressure sensor. This particular sensor is a General Purpose Series with built-in electronics.

Sensor Construction

Piezoelectric pressure sensors are available in various shapes and thread configurations to allow suitable mounting for various types of pressure measurements. Quartz crystals are used in most sensors to ensure stable, repeatable operation. The quartz crystals are usually preloaded in the housings to ensure good linearity. Tourmaline, another stable naturally piezoelectric crystal, is used in some PCB sensors where volumetric sensitivity is required.

Polarity

When a positive pressure is applied to an ICP pressure sensor, the sensor yields a positive voltage. The polarity of PCB charge mode pressure sensors is just the opposite: when a positive pressure is applied, the sensor yields a negative output. Charge output sensors are usually used with external charge amplifiers that invert the signal. Therefore, the resulting system output polarity of a charge output sensor used with a charge amplifier will produce an output that is the same as an ICP sensor. (Reverse polarity sensors are also available.)

High Frequency Response

Most PCB piezoelectric pressure sensors are constructed with either compression mode quartz crystals preloaded in a rigid housing, or unconstrained tourmaline crystals. These designs give the sensors microsecond response times and resonant frequencies in the hundreds of kHz, with minimal overshoot or ringing. Small diaphragm diameters ensure spatial resolution of narrow shockwaves.

High-frequency response and rise time can be affected by mounting port geometry and associated electronics. (Limitations of driving long cables at high frequencies are discussed on page 148).

Check all system component specifications before making measurements, or contact PCB for application assistance.

Why Only Dynamic Pressure Can Be Measured With Piezoelectric Pressure Sensors

The quartz crystals of a piezoelectric pressure sensor generate a charge when pressure is applied. However, even though the electrical insulation resistance is quite large, the charge eventually leaks to zero. The rate at which the charge leaks back to zero is dependent on the electrical insulation resistance.

In a charge mode pressure sensor used with a voltage amplifier, the leakage rate is fixed by values of capacitance and resistance in the sensor, by low-noise cable, and by the external source follower voltage amplifier used. In the case of a charge mode pressure sensor used with a charge amplifier, the leakage rate is fixed by the electrical feedback resistor and capacitor in the charge amplifier.

In a pressure sensor with built-in ICP electronics, the resistance and capacitance of the crystal and the built-in ICP electronics normally determine the leakage rate.

Technical Information-Pressure

Typical Piezoelectric System Output

The output characteristic of piezoelectric pressure sensor systems is that of an AC-coupled system, where repetitive signals decay until there is an equal area above and below the original base line. As magnitude levels of the monitored event fluctuate, the output remains stabilized around the base line with the positive and negative areas of the curve remaining equal. **Figure 33** represents an AC signal following this curve. (Output from sensors operating in DC mode follow this same pattern but over an extended time frame associated with system discharge time constant values.)

For example, assume that a 0 to 2 volt output signal is generated from an AC-coupled pressure application with a one-second steady-state pulse rate and one second between pulses. The frequency remains constant, but the signal quickly decays negatively until the signal centers around the original base line (where area A = area B). Peak to peak output remains the same.

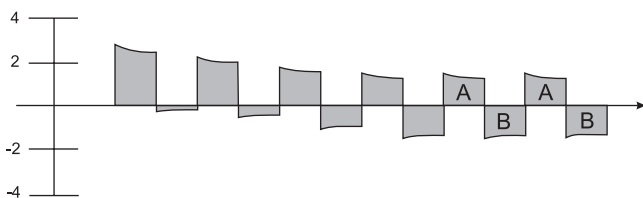

Figure 33. Repetitive Pulse AC Signal

Installation

Precision mounting of pressure sensors is essential for good pressure measurements. Although some mounting information is shown in this catalog, always check the installation drawings supplied in the manual with the sensor, or contact PCB to request detailed mounting instructions. Use good machining practices for the drilling and threading of mounting ports, and torque the sensors to the noted values. Mounting hardware is supplied with PCB sensors. Various standard thread adaptors are available to simplify some sensor installations.

For free field blast applications, try to use “aerodynamically clean” mounts, minimizing unwanted reflections from mounting brackets or tripods.

The sensing crystals of many pressure sensors described in this catalog are located in the diaphragm end of the sensor. Side loading of this part of the sensor during a pressure measurement creates distortions in the signal output. See **Figure 34**.

Also important is the avoidance of unusual side loading stresses and strains on the upper body of the sensor. Proper installation minimizes distortions in the output signal. A taut cable pulling at right angles to the electrical connector is an example of putting a side strain into the body. Another is the use of a heavy adaptor with cable attached to the small electrical connector in an environment with high transverse vibration.

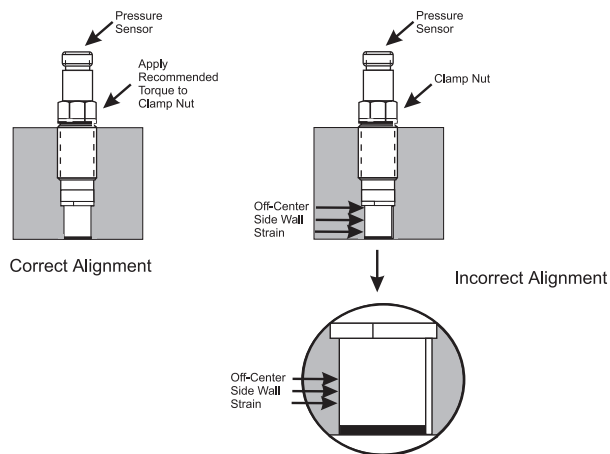

Figure 34. Flush Mount Pressure Alignment

In some types of applications, such as free-field blast measurements, a pressure sensor mounted in a thin plate can be subjected to side loading stresses when the pressure causes the plate to flex. Use of an O-ring mount minimizes this effect.

Flush VS. Recess Mounting

Flush mounting of pressure sensors in a plate or wall is sometimes desirable for minimizing turbulence, avoiding a cavity effect, or avoiding an increase in a chamber volume. Recess mounting is more desirable in applications where the diaphragm end of the pressure sensor is likely to be subjected to excessive flash temperatures or particle impingement.

Most PCB pressure sensors are supplied with seal rings for flush mounting. Certain models, such as Series 111, 112, and 113 can be provided with seal sleeves for recess mounting ports. See **Figure 35**. Request seal sleeves when ordering.

Consider ordering enough spare seal rings or sleeves, particularly in applications that require frequent removal and reinstallation of the pressure sensor. Before reinstalling a pressure sensor, be sure to check the mounting port to be sure that an old, distorted seal ring is not still in the mounting hole. If you are using PCB pressure sensors and find that you have lost or misplaced the seals, call PCB and request that the needed items be sent out as no-charge samples.

In this catalog, various mounting adaptors are described that often facilitate mounting of the pressure sensors. See pages 69 to 70 for details. Note that pressure sensors and adaptors with straight machined threads use a seal ring as a pressure seal. Pipe thread adaptors have a tapered thread, which results in the threads themselves creating the pressure seal.

Control of the location of the pressure sensor diaphragm is achieved with a straight thread/seal ring mount. Pipe thread mounts do not allow a precision

Technical Information-Pressure

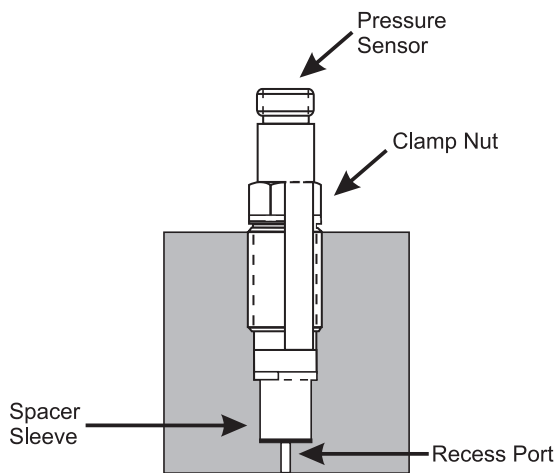

Figure 35. Typical Recess Mount

positioning of the depth of the sensor since the seal is provided by progressive tightening of threads in the tapered hole until the required thread engagement is reached. However, pipe threads do offer a convenience of an easier machined port than straight threads. Pipe thread mounts are well suited for some general applications.

Thermal Shock

Automotive in-cylinder pressures, ballistic pressures, and free-field blasts are a few examples of applications that have a thermal shock accompanying the pressure pulse. The thermal shock can be in the form of a radiant heat, such as the flash from an explosion, heat from convection of hot gasses passing over a pressure sensor's diaphragm, or conductive heat from a hot liquid.

Virtually all pressure sensors are sensitive to thermal shock. When heat strikes the diaphragm of a piezoelectric pressure sensor that has crystals contained in an outer housing, the heat can cause an expansion of the case surrounding the internal crystals. Although quartz crystals are not significantly sensitive to thermal shock, the case expansion causes a lessening of the preload force on the crystals, usually causing a negative-signal output. To minimize this effect, various methods are used.

Certain PCB quartz pressure sensors feature internal thermal isolation designs to minimize the effects of thermal shock. Some feature baffled diaphragms. Other models designed for maximizing the frequency response may require thermal protection coating, recess mounting, or a combination to lessen the effects of thermal shock. Examples of coatings include silicone grease, which may also be used to fill a recess mounting hole, RTV silicone rubber, vinyl electrical tape, and ceramic coatings. The RTV and tape are used as ablatives, while the ceramic coating is also used to protect some diaphragms from corrosive gasses and particle impingements.

Crystals other than quartz are used in some PCB sensors. Though sensitive to thermal shock, tourmaline is used for shock tube and underwater blast sensors. In shock tube measurements, the duration of the pressure measurement is usually so short that a layer of vinyl tape is sufficient to delay the thermal effects for the duration of the measurement. In underwater blast applications, heat transfer through the water is not significant.

Note that thermal shock effects do not relate to the pressure sensor specification called "temperature coefficient" used in this catalog. The temperature coefficient specification refers to the change in sensitivity of the sensor relative to the static temperature of the sensor. Unfortunately, since the thermal shock effects cannot be easily quantified, they must be anticipated and minimized by one of the above mentioned techniques in order to ensure better measurement data.

Pressure Transducers and Transmitters

Introduction

The 1500 series Pressure Transducers and Transmitters are designed to provide a highly stable and accurate measurement of fluid (liquid and/gas) of pressure from true DC to 1,000 Hz.

Description

All models utilize a sensing element that changes resistance in proportion to changes in applied pressure, which is sensed by a recessed diaphragm. This change in resistances is conditioned and amplified to provide a high level output. Various mechanical and electrical interfaces are available.

Installation

Mechanical (please refer to the specification sheet and installation drawing for given model)

1. Wrench only on the wrench flats for mounting or removing the unit. Do not use the housing or electrical terminals for wrenching.
2. The pressure cavity, unless specified is manufactured from 17-4 and 316 stainless steels and is suitable for use with all media compatible with those materials.
3. To prevent performance degradation unit must be protected from exposure to pressure transients and spikes that exceed the rated proof pressure range.

Electrical

(Please refer to the specification sheet or 1500 series data sheet for specific wiring and excitation requirements.)

1. Units must have proper excitation to perform within specification. Insufficient power may present the unit from providing the full rated output at full rated pressure.
2. Internal electronics can be damaged by power surges.
3. Electrical termination must be made in a NEMA 4 or better enclosure. Care must be taken to prevent migration of fluids into the cable.

Polarity

All units are designed to provide an increasing output with increasing pressure.

Technical Information-Force

Introduction to Quartz Force Sensors

Quartz Force Sensors are well-suited for dynamic force measurement applications. They are not interchangeable with strain gage load cells used for static force measurements. (also offered by PCB)

Measurements of dynamic oscillating forces, impact or high speed compression/tension under varying conditions may require sensors with special capabilities. Fast response, ruggedness, high stiffness, extended range and the ability to also measure quasi-static forces are standard features associated with PCB® quartz force sensors.

The following information presents some of the design and operating characteristics of PCB® quartz force sensors to help you better understand how they function, which in turn, will help you make better dynamic measurements.

Types of Quartz Force Sensors

This catalog describes two modes of operation for quartz force sensors manufactured by PCB®. ICP® (IEPE, or voltage output type sensors) feature built-in microelectronic amplifiers, which convert the high-impedance electrostatic charge signal from the crystals into a low-impedance voltage output signal (ICP® is a registered trademark of PCB Piezotronics, Inc., Inc.). The other type are charge output force sensors, which directly output a high-impedance electrostatic charge signal.

Sensor Construction

Both modes of operation for PCB® force sensors feature similar mechanical construction. Most are designed with thin quartz crystal discs that are "sandwiched" between upper and lower base plates. An elastic, beryllium-copper stud holds the plates together and pre-loads the crystals (pre-loading assures parts are in intimate contact to ensure linearity and provide the capability for tensile force measurements). This "sensing element" configuration is then packaged into a rigid, stainless-steel housing and welded to assure the internal components are sealed against contamination.

Figure 36 illustrates the cross-section of a typical quartz force sensor. This particular sensor is a general purpose Series 208 compression/tension model with built-in electronics.

When force is applied to this sensor, the quartz crystals generate an electrostatic charge that is proportional to the input force. This charge output is collected on an electrode that is sandwiched between the crystals. It is then either routed directly to an external charge amplifier or converted to a low-impedance voltage signal within the sensor. Both these modes of operation will be examined in the following sections.

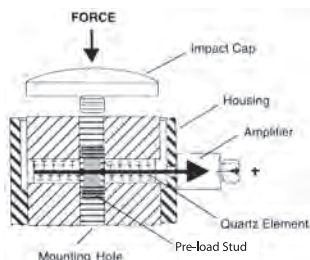

Figure 36. Compression-Tension-Impact Series 208

Conventional Charge Output Sensors

A charge output piezoelectric force sensor, when stressed, generates an electrostatic charge from the crystals. For accurate analysis or recording purposes, this high-impedance charge must be routed through a special low-noise cable to an impedance converting amplifier such as a laboratory charge amplifier or source follower. Connection of the sensor directly to a readout device such as an oscilloscope is possible for high-frequency impact indication, but is not suitable for most quantitative force measurements.

The primary function of the charge or voltage amplifier is to convert the high-impedance charge output to a usable low-impedance voltage signal for analysis or recording purposes. Laboratory charge amplifiers provide added versatility for signal normalization, ranging and filtering. PCB®'s electro-static charge amplifiers have additional input adjustments for quasi-static measurements, static calibration, and drift-free dynamic operation. Miniature in-line amplifiers are generally of fixed range and frequency.

Quartz charge output force sensors can be used at operating temperatures up to +400 °F (+204 °C).

When considering the use of charge output systems, remember that the output from the crystals is a pure electrostatic charge. The internal components of the force sensor and the external electrical connector maintain a very high (typically $>10^{12}$ ohm) insulation resistance so that the electrostatic charge generated by the crystals does not "leak away." Consequently, any connectors, cables or amplifiers used must also have a very high insulation resistance to maintain signal integrity.

Environmental contaminants such as moisture, dirt, oil, or grease can all contribute to reduced insulation, resulting in signal drift and inconsistent results.

The use of special, low- noise cable is required with charge output force sensors. Standard, two-wire or coaxial cable, when flexed, generates an electrostatic charge between the conductors. This is referred to as "triboelectric noise" and cannot be distinguished from the sensor's crystal electrostatic output. Low-noise cables have a special graphite lubricant between the dielectric shield which minimizes the triboelectric effect.

Page 143 shows a typical charge output sensor system schematic including: sensor, low-noise cable, and charge amplifier.

If the measurement signal must be transmitted over long distances, PCB® recommends the use of an in-line charge converter, placed near the force sensor. This minimizes the chance of noise. In-line charge converters can be operated from the same constant-current excitation power source as ICP® force sensors to minimize system cost. **Page 143** shows two typical charge output systems and their components.

Technical Information-Force

ICP® Low-Impedance Quartz Force Sensors

ICP® force sensors incorporate a built-in MOSFET microelectronic amplifier. This serves to convert the high-impedance charge output into a low-impedance voltage signal for analysis or recording. ICP® sensors, powered from a separate constant current source, operate over long ordinary coaxial or ribbon cable without signal degradation. The low-impedance voltage signal is not affected by triboelectric cable noise or environmental contaminants.

Power to operate ICP® sensors is generally in the form of a low cost, 24 to 27 VDC, 2 to 20 mA constant current supply. **Page 144** schematically illustrates a typical ICP® sensor system. PCB® offers a number of AC or battery powered, single or multi-channel power/signal conditioners, with or without gain capabilities, for use with force sensors (see Signal Conditioners Section of this catalog for available models). In addition, many data acquisition systems now incorporate constant current power for directly powering ICP® sensors. Because static calibration or quasi-static short-term response lasting up to a few seconds is often required, PCB® also manufactures signal conditioners that provide DC coupling.

Page 145 summarizes a complete 2-wire ICP® system configuration. In addition to ease of operation, ICP® force sensors offer significant advantages over charge output types. Because of the low-impedance output and solid-state, hermetic construction, ICP® force sensors are well-suited for continuous, unattended force monitoring in harsh factory environments. Also, ICP® sensor cost-per-channel is substantially lower, since they operate through standard, low-cost coaxial cable, and do not require expensive charge amplifiers.

Polarity

The output voltage polarity of ICP® force sensors is positive for compression and negative for tension force measurements. ICP® strain sensors have the opposite polarity. The polarity of PCB® charge output force sensors is the opposite: negative for compression and positive for tension. This is because charge output sensors are usually used with external charge amplifiers that exhibit an inverting characteristic. Therefore, the resulting system output polarity of the charge amplifier system is positive for compression and negative for tension; same as for an ICP® sensor system (reverse polarity sensors are also available).

Why Can Only Dynamic Force be Measured with Piezoelectric Force Sensors?

The quartz crystals of a piezoelectric force sensor generate an electrostatic charge only when force is applied to or removed from them. However, even though the electrical insulation resistance is quite large, the electrostatic charge will eventually leak to zero through the lowest resistance path. In effect, if you apply a static force to a piezoelectric force sensor, the electrostatic charge output initially generated will eventually leak back to zero.

The rate at which the charge leaks back to zero is dependent on the lowest insulation resistance path in the sensor, cable and the electrical resistance/capacitance of the amplifier used.

In a charge output force sensor, the leakage rate is usually fixed by values of capacitance and resistance in the low-noise cable and external charge or source follower amplifier used.

In an ICP® force sensor with built-in electronics, the resistance and capacitance of the built-in circuitry normally determines the leakage rate.

When a rapid dynamic force is applied to a piezoelectric force sensor, the electrostatic charge is generated quickly and, with an adequate discharge time constant, does not leak back to zero. However, there is a point at which a slow speed dynamic force becomes quasi-static and the leakage is faster than the rate of the changing force. Where is the point at which the force is too slow for the piezoelectric force sensor to make the measurement? See the next section on Discharge Time Constant for the answer.

Discharge Time Constant (DTC)

When leakage of a charge (or voltage) occurs in a resistive capacitive circuit, the leakage follows an exponential decay. A piezoelectric force sensor system behaves similarly in that the leakage of the electrostatic charge through the lowest resistance also occurs at an exponential rate. The value of the electrical capacitance of the system (in farads), multiplied by the value of the lowest electrical resistance (in ohm) is called the Discharge Time Constant (in seconds).

DTC is defined as the time required for a sensor or measuring system to discharge its signal to 37% of the original value from a step change of measurand. This is true of any piezoelectric sensor, whether the operation be force, pressure or vibration monitoring. The DTC of a system directly relates to the low frequency monitoring capabilities of a system and, in the case of force monitoring, becomes very important as it is often desired to perform quasi-static measurements.

DTC Charge Output System

In a charge output system, the sensors do not contain built-in amplifiers, therefore, the DTC is usually determined by the settings on an external charge amplifier. A feedback resistor working together with a capacitor on the operational amplifier determines the time constant. PCB®'s laboratory-style charge amplifiers feature short, medium and long time constant selections. It is assumed that the electrical insulation resistance of the force sensor and cable connecting to the charge amplifier are larger than that of the feedback resistor in the charge amplifier; otherwise, drift will occur. Therefore, to assure this, the force sensor connection point and cable must be kept clean and dry.

Low Frequency Response of ICP® Systems

With ICP® force sensors, there are two factors which must be considered when making low frequency measurements. These are:

1. The discharge time constant characteristic of the ICP® force sensor.
2. The discharge time constant of the AC coupling circuit used in the signal conditioner (if DC coupling is used, only (1) above needs to be considered).

It is important that both factors be readily understood by the user to assure accurate low frequency measurements.

Technical Information-Force

DTC in ICP® Force Sensors

The DTC is fixed by the components in an ICP® sensor's internal amplifier. Specifications for the ICP® force sensors shown in this catalog list the DTC for each force sensor.

When testing with ICP® sensors, there are two time constants that must be considered for low frequency determination, one being that of the sensor which is a fixed value, and the other being that of the coupling electrical circuit used in the signal conditioner.

When an ICP® sensor is subjected to a step function input, a quantity of charge, q , is produced proportional to the mechanical input. According to the law of electrostatics, output voltage is $\Delta V = \Delta q / \Delta C$ where C is the total capacitance of the sensing element, amplifier, and ranging capacitor.

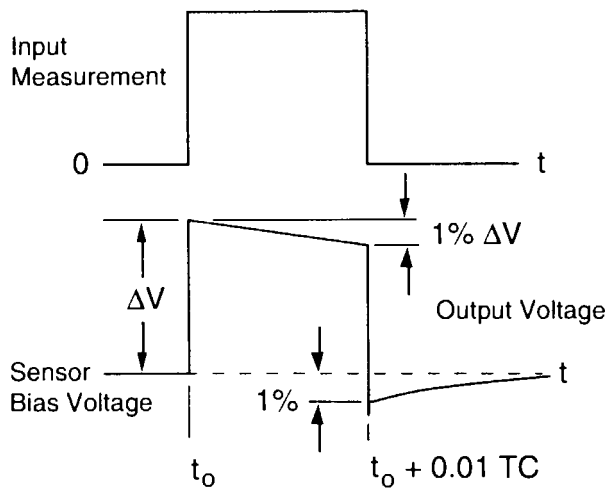

Figure 37. Step Function Response

Long Duration Events and DTC

It is often desired to measure an input pulse lasting a few seconds in duration. This is especially true with force sensor applications where static calibration or quasi-static measurements take place. Before performing tests of this nature, it is important to DC couple the entire monitoring system to prevent rapid signal loss. PCB®'s AC/DC mode signal conditioners are designed for such applications.

The general rule of thumb for such measurements is that the output signal loss and time elapsed over the first 10% of a DTC have an approximate one to one relationship. If a sensor has a 500 second DTC, over the first 50 seconds, 10% of the original input signal will have decayed. For 1% accuracy, data should be taken in the first 1% of the DTC. If 8% accuracy is acceptable, the measurement should be taken within 8% of the DTC, and so forth. **Figure 37** graphically demonstrates this event.

Left unchanged, the signal will naturally decay toward zero. This will take approximately 5 DTC. You will notice that after the original step impulse signal is removed, the output signal dips below the base line reference point ($t_0 + 0.01 TC$). This negative value is the same value as has decayed from the original impulse (shown as 1% in **Figure 37**). Further observation will reveal that the signal, left untouched, will decay upwards toward zero until equilibrium in the system is observed.

Force Sensor Natural Frequency

Unlike the low frequency response of the sensor, which is determined electrically through the $DTC = RC$ equation, the high frequency response is determined by the sensor's mechanical configuration (unless electrical low-pass filtering has been added). Each force sensor has an upper frequency limit specification which should be observed when determining upper linear limits of operation.

Installation

Proper installation of quartz force sensors is essential for accurate dynamic measurement results. Although rugged PCB® quartz force sensors are forgiving to some degree, certain basic procedures should be followed.

Since most PCB® force sensors are designed with quartz compression plates to measure forces applied in an axial direction, aligning the sensor and contact surfaces to prevent edge loading or bending moments in the sensor will produce better dynamic measurement results.

Having parallelism between the sensor and test structure contact surfaces minimizes bending moments and edge loading. Flatness of mounting surfaces will also affect the quality of the measurement. Using a thin layer of lubricant on mounting surfaces during installation creates better contact between sensor and mounting surface.

The mounting surfaces on PCB® force sensors are lapped during their manufacture to ensure that they are flat, parallel and smooth. Ring-style force sensors are supplied with anti-friction washers to minimize shear loading of the sensor surface when torquing between two surfaces.

Loading to the entire force sensor sensing surface is also important for good measurements. However, this can be difficult if the surface being brought into contact with the force sensor is flat but not parallel to the sensor mounting surface. In this case, an intermediate curved surface can lessen edge loading effects (See **Figure 38**).

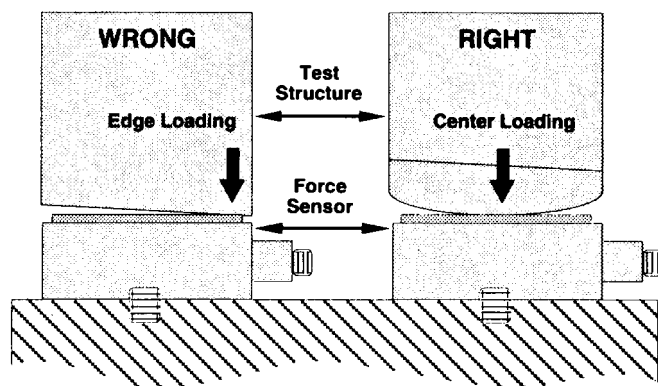

Figure 38. Edge vs. Central Loading

Technical Information-Force

Installation (continued)

Series 208 force sensors are supplied with a convex curved impact cap to help spread the forces over the entire surface of the force sensor.

One other consideration when mounting force sensors is to minimize unnecessary mechanical high frequency shock loading of the sensors. **The high frequency content of direct metal-to-metal impacts can often create short duration, high “g” overloads in structures and sensors. This problem can be minimized by using a thin damping layer of a softer material on the interface surface between the structure and sensor being impacted (it should be considered beforehand whether the slight damping of the high frequency shock is critical to the force measurement requirements).** The impact surface on Series 200 and the impact caps on Series 208 force sensors are supplied with thin layers of damping material.

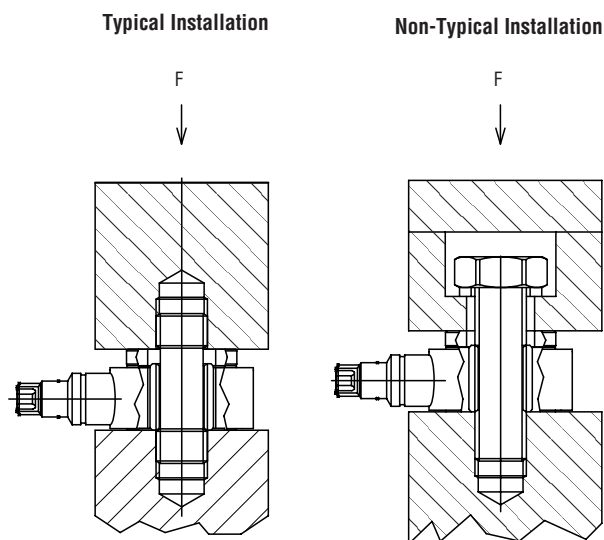

Figure 39. Force Ring Sensor Installations

Pre-Loading Force Rings and 3-Component Force Sensors

PCB® ring-style 1-component and 3-component force sensors are generally installed between two parts of a test structure with the supplied elastic beryllium-copper stud or customer-supplied bolt. The stud or bolt holds the structure together, and applies pre-load to the force ring as shown in **Figure 39**. In the typical installation, shown on the left side in **Figure 39**, part of the force between the two structures is shunted through the mounting stud. The amount of force shunted may be up to 7% of the total force for the beryllium-copper stud supplied with the sensor, and up to 50% for steel studs. This typical installation setup is used by PCB® during standard calibrations.

A non-typical installation is shown on the right side in **Figure 39**. In this non-typical installation, the stud or bolt used to apply the pre-load does not shunt part of the applied force. The plate on top of the sensor has a clearance hole that the stud or bolt passes through. In this installation, the stud or bolt is not directly connected to the top plate by its threads, as it is in the typical installation, so it does not shunt any force.

NOTE: If any of the following conditions apply to the pre-loading of the force ring in the application, the sensitivity and linearity performance of the sensor will not match the standard PCB® calibration values.

1. Use of a stud or bolt other than the supplied beryllium-copper stud
2. Use of no stud or bolt
3. Use of an amount of pre-load other than the recommended amount
4. Use of the non-typical installation setup shown below

In these cases, please contact a PCB® application engineer to discuss your special calibration requirements.

PCB® in-house calibration procedure requires the installation of a force ring with beryllium-copper stud, in the typical installation setup above, in series with a NIST traceable reference sensor. Generally, a pre-load of 20% (full-scale operating range of the force ring) is applied before recording of measurement data. Contact a PCB® application specialist for proper pre-load requirements. Allow the static component of the signal to discharge before calibration.

Three-component force sensors must be pre-loaded to achieve proper operation, particularly for the shear x-, and y-axis. The recommended applied pre-load for three-component force sensors is 10 times their x or y axes measurement range. This pre-load provides the sensing crystals with the compressive loading required to achieve an output in response to shear direction input forces. As with force rings, the sensitivity achieved from a 3-component force sensor is dependent upon the applied pre-load and the elasticity characteristics of the mounting bolt or stud used. If the unit is to be installed with a stud or bolt other than the supplied elastic, beryllium-copper stud, a calibration using the actual mounting hardware must be performed. Errors in sensitivity of up to 50% can result by utilizing studs or bolts of different materials.

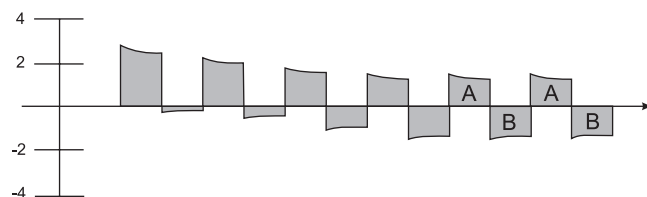

Figure 40. Repetitive Pulse, AC Signal

Typical Piezoelectric System Output

The output characteristic of piezoelectric sensors is that of an AC coupled system, where repetitive signals will decay until there is an equal area above and below the original base line. As magnitude levels of the monitored event fluctuate, the output will remain stabilized around the base line with the positive and negative areas of the curve remaining equal. **Figure 40** represents an AC signal following this curve (output from sensors operating in DC mode following this same pattern, but over an extended time frame associated with sensor time constant values).

Example: Assuming a 0 to 3 volt output signal is generated from an AC coupled force application with a one second steady-state pulse rate and one second between pulses. The frequency remains constant, but the signal quickly decays negatively until the signal centers around the original base line (where area A = area B). Peak-to-peak output remains the same.

Technical Information-Force

Repetitive Pulse Applications

In many force monitoring applications, it is desired to monitor a series of zero-to-peak repetitive pulses that may occur within a short time interval of one another. This output signal is often referred to as a "pulse train". As has been previously discussed, the AC coupled output signal from piezoelectric sensors will decay towards an equilibrium state, making it look like the positive force is decreasing. In this scenario, it would be difficult to accurately monitor a continuous zero-to-peak output signal such as those associated with stamping or pill press applications. With the use of special ICP® sensor signal conditioning equipment it becomes possible to position an output signal positive going above a ground-based zero. Operating in drift-free AC mode, PCB®'s Model 484B02 or a Model 410B01 ICP® sensor signal conditioner provides the constant current voltage excitation to ICP® force sensors and has a zero-based clamping circuit that electronically resets each pulse to zero. As outlined in **Figure 41**, this special circuitry prevents the output from drifting negatively, and provides a continuous, positive polarity signal.

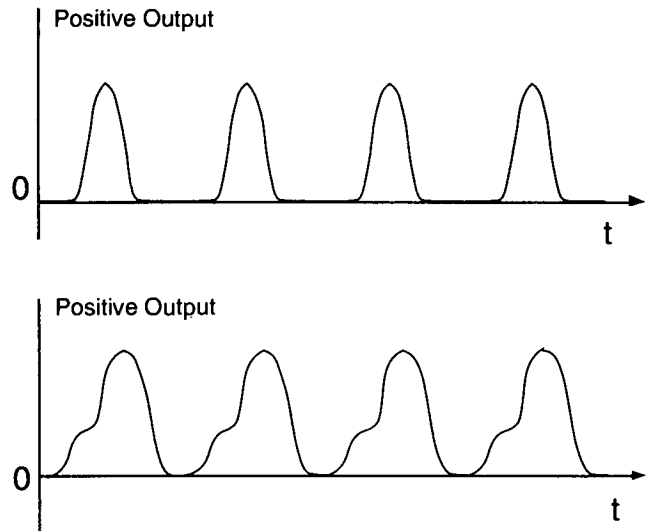

Figure 41. Positive Polarity, Zero-based AC Output

ICP® 3-Component Force Measurement System

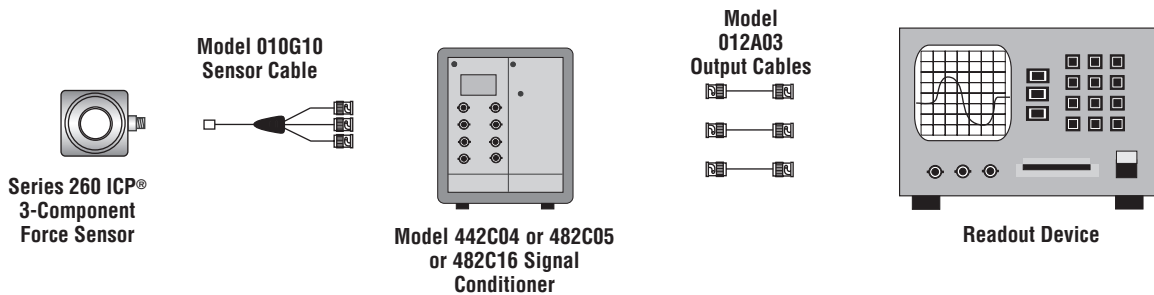

Figure 42. System Utilizing an ICP® Sensor Signal Conditioner

Charge Output Force Measurement System

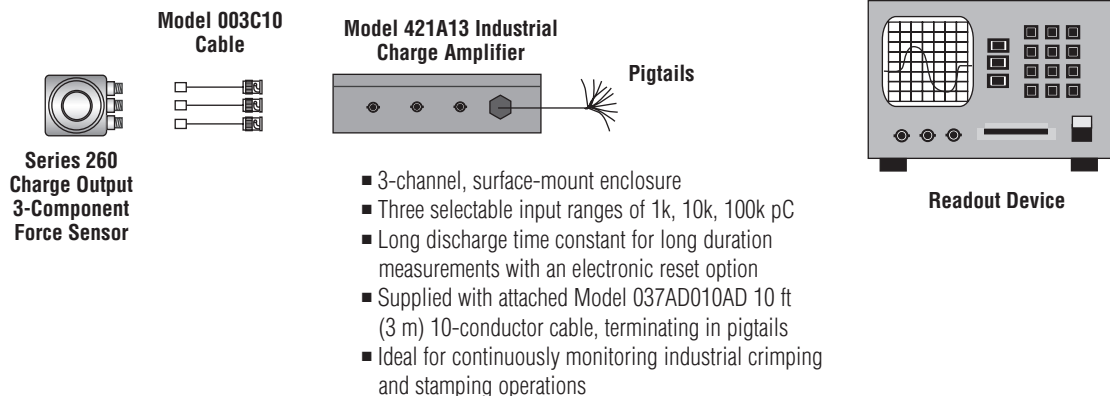

Figure 43. Low-cost System Utilizing 3-Channel Industrial Charge Amplifier

Technical Information-Strain

Introduction

ICP® quartz strain sensors incorporate a built-in MOSFET microelectronic amplifier. This serves to convert the high impedance charge output into a low impedance voltage signal for analysis or recording. ICP® quartz strain sensors, powered from a separate constant current source, operate over long ordinary coaxial or ribbon cable without signal degradation. The low impedance voltage signal is not affected by triboelectric cable noise or environmental contaminants. Power to operate ICP® sensors is generally in the form of a low cost, 24-27 VDC, 2-20 mA constant current supply. **Figure 44** schematically illustrates a typical ICP® strain sensor system. PCB® offers a number of AC or battery-powered, single or multi-channel power/signal conditioners, with or without gain capabilities for use with strain sensors. In addition, many data acquisition systems now incorporate constant current power for directly powering ICP® sensors. Because static calibration or quasi-static short-term response lasting up to a few seconds is often required, PCB® manufactures signal conditioners that provide DC coupling.

ICP® quartz strain sensors are well suited for continuous, unattended strain monitoring in harsh factory environments. Also, ICP® sensor cost-per-channel is substantially lower, since they operate through standard, low-cost coaxial cable, and do not require expensive charge amplifiers.

Refer to the installation/outline drawing and specification for details and dimensions of the particular sensor model number(s) purchased.

Description

240 series quartz strain sensors are used to monitor the dynamic response of crimping, stamping, punching, forming and any other applications where it is crucial to maintain process control. These sensors are ideal in applications where mounting directly in the load path with a force sensor is not possible. Instead, the sensor can be mounted in an area that will provide the highest mechanical stress for the process to be monitored. Strain sensors are mounted to a structure by means of a supplied socket flat head screw, which threads into a corresponding tapped hole, and is then fastened securely. When used with a constant current signal conditioner, the sensor output voltage can be resolved in units of strain and then related to specific events that must be monitored in the process. After defining a signature voltage response for properly manufactured parts, the user can then determine an acceptable upper and lower control limit in order to maintain process control thereby preventing the acceptance of non-conforming products as finished goods. Versions offering full-scale measurements of $10 \mu\epsilon$ to $300 \mu\epsilon$ are available. When powered by a constant current power supply and subjected to an input strain, an ICP® strain sensor will provide a corresponding output voltage. A positive output voltage indicates that the structure being monitored is being subjected to a tensile force in the sensor mounting area and can also be resolved in units of strain. Likewise, a compressive force in this area will result in a negative output voltage.

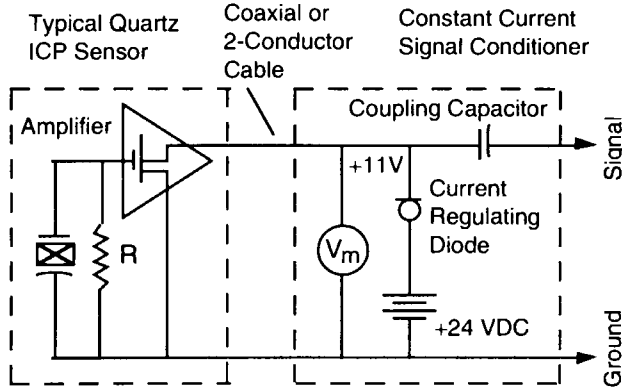

Figure 44. ICP® Sensor System Schematic

Typical ICP® Strain Sensor Measurement System

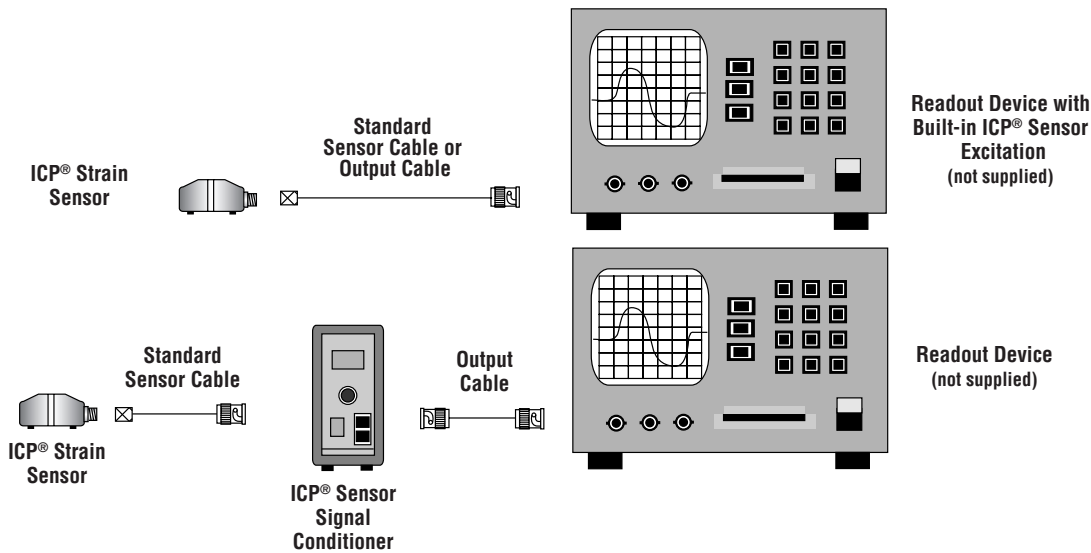

Figure 45.

* Low-noise cables are required to maintain $\epsilon\epsilon$ conformance.

Technical Information-Strain

General Installation

Refer to the Installation Drawing for specific outline dimensions and installation details for your particular model.

It is important that the mounting surface is clean and free of paint, oil, or other coatings that could prevent the proper transfer of strain into the mounting pads of the sensor. Poor surface contact may affect sensor sensitivity and result in erroneous data. Prior to mounting, it is recommended that the machine surface and the mounting pads of the sensor be cleaned with acetone. This will maintain proper coupling with these mating surfaces and prevent slippage at peak strain.

Connect one end of the coaxial cable to the sensor connector and the other end to the XDCR jack on the signal conditioner. Make sure to tighten the cable connector to the sensor. DO NOT spin the sensor onto the cable, as this fatigues the cable's center pin, resulting in a shorted signal and a damaged cable. If the cable cannot be attached prior to sensor installation, the protective cap should remain on the connector to prevent contamination or damage.

For installation in dirty, humid, or rugged environments, it is suggested that the connection be shielded against dust or moisture with shrink tubing or other protective material. Strain relieving the cable/sensor connection can also prolong cable life. Mounting cables to a test structure with tape, clamps, or adhesives minimizes the chance of damage.

Strain Sensor Installation

Figure 46 displays the sensor mounted using the supplied mounting screw to a minimum torque of 10 N-m. Allow for the static component of the signal to discharge prior to calibration. Installations not preloaded to the recommended value, or that utilizes a screw of different material and/or dimensions than the supplied screw, may yield inaccurate output readings. The supplied screw allows proper strain transmission to the sensor while holding the sensor in place. Properly machined holes for the mounting screw will ensure proper vertical orientation of the sensor. Refer to the installation drawing for additional mounting details. Consult a PCB® applications engineer for calibration and output recommendations.



Series M240 Industrial ICP® Strain Sensors

Polarity

Extension of the mounting area of an ICP® strain sensor produces a positive-going voltage output. The retraction of the mounting area produces a negative-going voltage output.

Low-Frequency Monitoring

Strain sensors used for applications in short term, steady-state monitoring, such as sensor calibration, or short term, quasistatic testing should be powered by signal conditioners that operate in DC-coupled mode. PCB® Series 484 Signal Conditioner operates in either AC or DC-coupled mode and may be supplied with gain features or a zero "clamped" output often necessary in repetitive, positive polarity pulse train applications.

If you wish to learn more about ICP® sensors, consult PCB®'s General Signal Conditioning Guide, a brochure outlining the technical specifics associated with piezoelectric sensors. This brochure is available from PCB® by request, free of charge.

Calibration

Strain sensors are calibrated relative to a strain gage reference sensor. A calibration certificate is supplied with each strain sensor providing its relative voltage sensitivity (mV/με). A calibration must be performed once strain sensors are installed in the specific equipment being measured. This is necessary so that a direct comparison of relative data can be made thereby allowing the user to set control limits and properly monitor a specific event as well as the entire process.

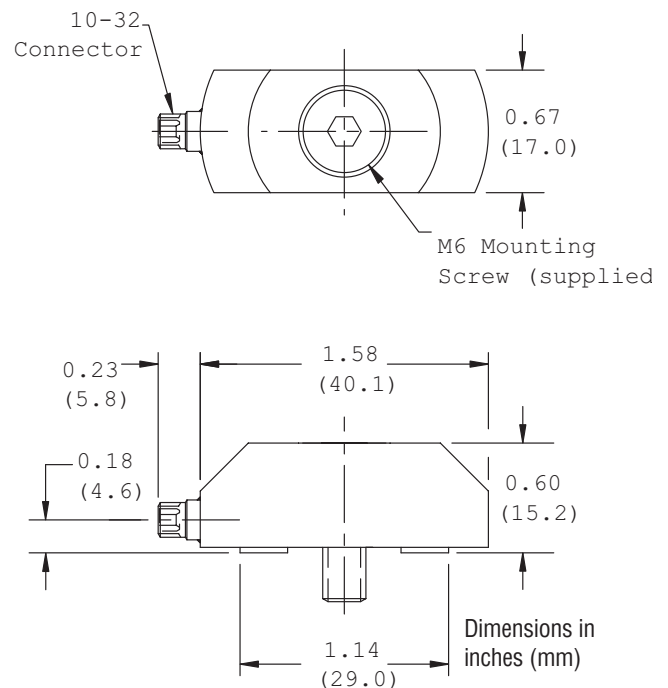

Figure 46. Strain Sensor Installation

Technical Information-Load Cell

Introduction to Load Cells

Principal of Operation

PCB Load & Torque manufactures a wide variety of load cells whose output voltage is proportional to the applied force produced by a change in resistance in strain gages which are bonded to the load cell's structure. The magnitude of the change in resistance corresponds to the deformation of the load cell and therefore the applied load.

The four-arm Wheatstone bridge configuration shown in **Figure 47** depicts the strain gages used in our load cells. This configuration allows for temperature compensation and cancellation of signals caused by forces not directly applied to the axis of the applied load.

A regulated 5 to 20 volt DC or AC rms excitation is required and is applied between A and D of the bridge. When a force is applied to the transducer structure, the Wheatstone bridge is unbalanced, causing an output voltage between B and C which is proportional to the applied load.

Most all PCB Load & Torque load cells follow a wiring code established by the Western Regional Strain Gage committee as revised in May 1960. The code is illustrated in **Figure 48**.

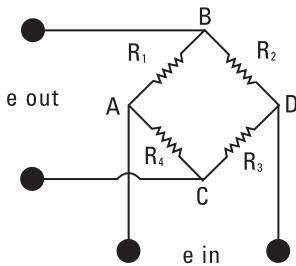

Figure 47. Wheatstone Bridge

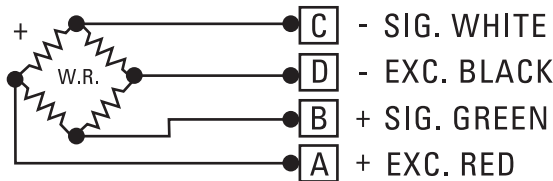

Figure 48. Load Cell Wiring Code

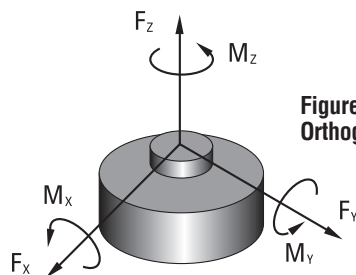

Figure 49. Right-handed Orthogonal Coordinate System

Axis Definition

Our load cells comply with the Axis and Sense Definitions of NAS-938 (National Aerospace Standard-Machine Axis and Motion) nomenclature and recommendations of the Western Regional Strain Gage committee.

These axes are defined in terms of a "right handed" orthogonal coordinate 2.

A tensile load exhibits a positive (+) polarity going output, while a compressive load exhibits a negative (-) polarity going output.

The primary axis of rotation or axis of radial symmetry of a load cell is the z-axis.

Principal of Operation

PCB Load & Torque manufactures load cells under two classifications. They are general purpose and fatigue-rated.

General Purpose

General purpose load cells are designed for a multitude of applications across the automotive, aerospace, and industrial markets. The general purpose load cell, as the name implies, is designed to be utilitarian in nature. Within the general purpose load cell market there are several distinct categories. They are: precision, universal, weigh scale, and special application. PCB Load & Torque primarily supplies general purpose load cells into the universal and special application categories. Universal load cells are the most common in industry. Special application load cells are load cells that have been designed for a specific unique force measurement task.

Special application load cells can be single axis or multiple axis. They include but not limited to:

- pedal effort
- steering column
- crash barrier
- hand brake
- tire test

Fatigue-rated Load Cells

Fatigue-rated load cells are specially designed and manufactured to withstand millions of cycles. They are manufactured using premium fatigue-resistant steel or aluminum and special processing to ensure mechanical and electrical integrity, as well as accuracy. Fatigue-rated load cells manufactured by PCB Load & Torque are guaranteed to last 100 million fully reversed cycles (full tension through zero to full compression). An added benefit of fatigue-rated load cells is their extreme resistance to extraneous bending and side loading forces.

Error Analysis

PCB Load & Torque typically supplies accuracy information on its products in the form of individual errors. They are: non-linearity, hysteresis, non-repeatability, effect of temperature on zero, and effect of temperature on output.

The customer can combine individual errors to establish the maximum possible error for the measurement, or just examine the applicable individual error. If

Technical Information-Load Cell

the temperature remains stable during the test, the temperature related errors can be ignored. If the sensor is used for increasing load measurement only, ignore the hysteresis error. If the load measurement is near the full capacity, the linearity error can be ignored. If the capability exists to correct the data through linearization-fit or a look-up table, the error in the measurement can be minimized. A sophisticated user can get rid of all the errors except for the non-repeatability error in the measurement.

Often overlooked by the customer is the error due to the presence of non-measured forces and bending moments. Even though the single axis of measurement sensors are designed and built to withstand these non-measured forces and bending moments (extraneous loads), the errors due to them are present. PCB Load & Torque engineers can design the set-up to eliminate or minimize these extraneous loads. However, if these extraneous loads are present, the errors due to them should be considered.

Due to cost restraints, PCB Load & Torque, as with its competition, does not typically measure or compensate for errors due to extraneous loads. If the presences of these extraneous loads are known, the user should request the transducer manufacturer to run a special test, at extra cost, to define and quantify the extraneous load errors. These errors are defined as cross-talk errors.



Typical Application Examples:

Hydraulic Actuators

Quality Control

Torque Arm

Life Cycle Testing

Material Fatigue Testing

Tank Weighing

Application Questionnaire

Determine the capacity required

- A. What is the maximum expected load?
- B. What is the minimum expected load?
- C. What is the typical expected load?
- D. What are the dynamics of the system, i.e. frequency response?
- E. What are the maximum extraneous loads to which the load cell will be subjected?

How will the load cell be integrated into the system?

- A. What are the physical constraints, e.g. height, diameter, thread?
- B. Will the load cell be in the primary load path or will the load cell see forces indirectly?

What type of environment will the load cell be operating in?

- A. Maximum temperature?
- B. Minimum temperature?
- C. Humidity?
- D. Contaminants, (e.g. water, oil, dirt, dust)?

What accuracy is required?

- A. Non-linearity?
- B. Hysteresis?
- C. Repeatability?
- D. Cross-talk?

Technical Information-Torque Sensor

Introduction to Torque Sensors

Principal of Operation

All torque sensors manufactured by PCB Load & Torque are strain gage based measuring instruments whose output voltage is proportional to applied torque. The output voltage produced by a resistance change in strain gages that are bonded to the torque sensor structure. The magnitude of the resistance change is proportional to the deformation of the torque sensor and therefore the applied torque.

The four-arm Wheatstone Bridge configuration shown in **Figure 50** depicts the strain gage geometry used in the torque sensor structures. This configuration allows for temperature compensation and cancellation of signals caused by forces not directly applied about the axis of the applied torque.

A regulated 5 to 20 volt excitation is required and is applied between points A and D of the Wheatstone bridge. When torque is applied to the transducer structure the Wheatstone bridge becomes unbalanced, thereby causing an output voltage between points B and C. This voltage is proportional to the applied torque.

Series 2300 reaction torque sensors have the wiring code illustrated in **Figure 51**. Series 4100 rotary transformer torque sensors have the wiring code illustrated in **Figure 52**.

Axis Definition

PCB Load & Torque torque sensors comply with the Axis and Sense Definitions of NAS-938 (National Aerospace Standard-Machine Axis and Motion) nomenclature and recommendations of the Western Regional Strain Gage committee.

Axes are defined in terms of a "right-handed" orthogonal coordinate system, as shown in **Figure 53**.

The principal axis of a transducer is normally the z-axis. The z-axis will also be the axis of radial symmetry or axis of rotation. In the event there is no clearly defined axis, the following preference system will be used: z, x, y.

The principal axis of a transducer is normally the z-axis. The z-axis will also be the axis of radial symmetry or axis of rotation. In the event there is no clearly defined axis, the following preference system will be used: z, x, y.

Figure 54 shows the axis and sense nomenclature for our torque sensors. A (+) sign indicates torque in a direction which produces a (+) signal voltage and generally defines a clockwise torque.

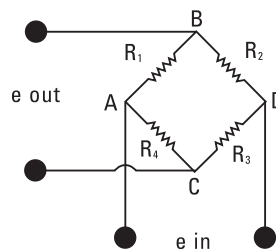

Figure 50. Wheatstone Bridge

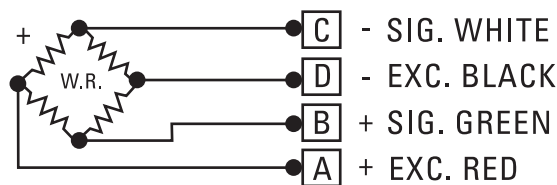

Figure 51. Series 2300 Reaction Torque Sensor Wiring Code

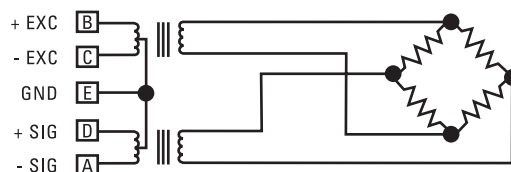

Figure 52. Series 4100 Rotary Transformer Torque Sensor Wiring Code

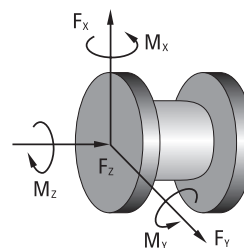

Figure 53. Right-handed Orthogonal Coordinate System

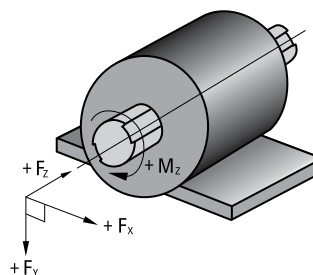

Figure 54. Axis and Sense Nomenclature for Torque Sensors

Technical Information-Torque Sensor

Torque Sensor Structure Design

Torque sensor structures are symmetrical and are typically manufactured from steel (SAE 4140 or 4340) that has been heat-treated Rc 36 to 38. Common configurations are solid circular shaft, hollow circular shaft, cruciform, hollow cruciform, solid square, and hollow tube with flats.

The solid square offers advantages over the solid circular design, especially in capacities greater than or equal to 500 in-lb (55 N-m). The solid square offers high bending strength and ease of application of strain gages. Torque sensors with capacities less than 500 in-lb (55 N-m) are usually of the hollow cruciform type. The hollow cruciform structure produces high stress at low levels of torque, yet has good bending strength. Common configurations are shown in **Figure 48**.

A variety of end configurations are available, including: keyed shaft, flange, and spline. (See below).

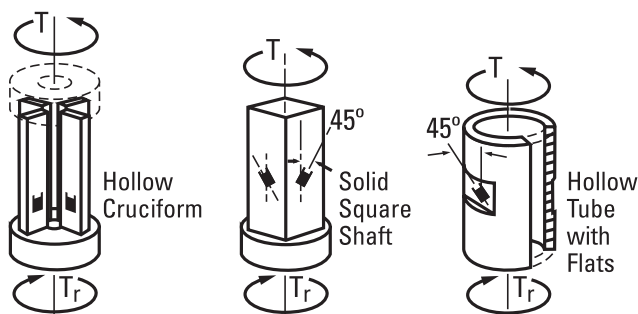

Figure 55. Common Torque Sensor Configurations

Reaction Torque Sensors

Typical reaction torque sensor applications include:

- Bearing friction
- Stepping switch torque
- Axle torsion test
- Starter testing
- Automotive brake testing

Reaction torque is the turning force or moment, imposed upon the stationary portion of a device by the rotating portion, as power is delivered or absorbed. The power may be transmitted from rotating member to stationary member by various means, such as the magnetic field of a motor or generator, brake shoes or pads on drums or rotors, or the lubricant between a bearing and a shaft. Thus, reaction torque sensors become useful tools for measuring properties such as motor power, braking effectiveness, lubrication, and viscosity.

Reaction torque sensors are suitable for a wide range of torque measurement applications, including motor and pump testing. Due to the fact that these sensors do not utilize bearings, slip-rings, or any other rotating elements, their installation and use can be very cost effective. Reaction torque sensors are particularly useful in applications where the introduction of a rotating inertia due to a rotating mass between the driver motor and driven load is undesirable. An example of this can be found in small motor testing, where introduction of a rotating mass between the motor and load device will result in an error during acceleration. For these applications, the reaction torque sensor can be used between the driver motor, or driven load, and ground. An added benefit is that such an installation is not limited in RPM by the torque sensor. PCB Load & Torque manufactures reaction torque sensors with capacities ranging from a few inch ounces to 500k in-lb (56.5k N-m), in configurations including keyed shaft and flange.



Keyed Shaft



Spline Drive

Technical Information-Torque Sensor

Rotary Torque Sensors

Typical rotary torque sensor applications include:

- Chassis dynamometer
- Engine dynamometer
- Efficiency testing
- Clutch testing
- Blower or fan testing
- Small motor / pump testing

Rotating torque sensors are similar in design and in application to reaction torque sensors, with the exception that the torque sensor is installed in-line with the device under test. Consequently, the torque sensor shaft rotates with the device under test. In PCB Load & Torque Series 4100 models, the rotating torque sensor shaft is supported in a stationary housing by two bearings. Signal transfer between the rotating torque sensor shaft and the stationary housing is accomplished by means of rotary transformers.

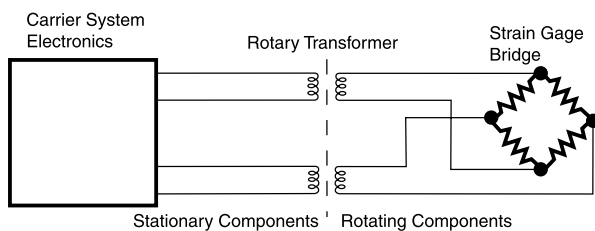

Figure 56.

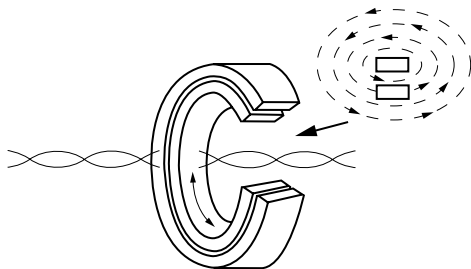

Figure 57.

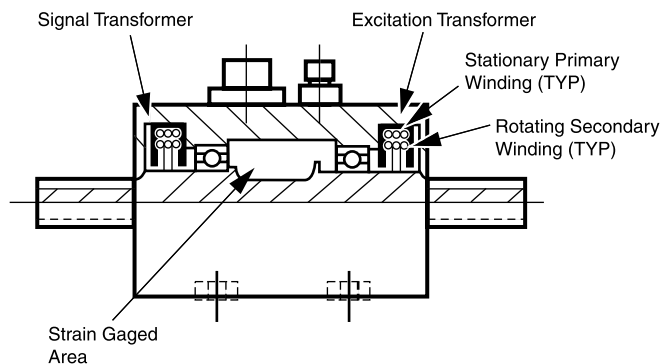

Figure 58. Rotary Transformer Torque Sensor Diagram

Rotary Transformers

Rotary Transformers provide a non-contact means of transferring signals to and from the rotating torque sensor structure. Rotary transformers are similar to conventional transformers, except that either the primary and secondary winding is rotating. For rotating torque sensors, two rotary transformers are used. One serves to transmit the excitation voltage to the strain gage bridge, while the second transfers the signal output to the non-rotating part of the transducer. Thus no direct contact is required between the stationary and rotating elements of the transducer (see **Figure 56**).

Rotary transformers are made up of a pair of concentrically wound coils, with one coil rotating within or beside the stationary coil. The magnetic flux lines are produced by applying a time varying voltage (carrier excitation) to one of the coils (see **Figure 57**).

Figure 58 depicts a typical rotary transformer torque sensor:

Transmission of energy through any transformer requires that the current be alternating. A suitable signal conditioner with carrier excitation in the range of 3 to 5000 Hz is required to achieve this.

Mechanical Installation of Keyed Shaft Torque Sensors

Proper installation must be observed when assembling a torque sensor into a driveline. Careful selection of components must be made so that problems are not created which could lead to part failure or danger to personnel.

Shaft misalignment

Provision must be made to eliminate the effects of bending and end loading on the torque sensors shaft due to parallel offset of shafts, angular misalignment, and shaft end float. The proper use of couplings can reduce these problems to a negligible level.

All shafts must first be aligned mechanically, as accurately as possible, to lessen the work the couplings must do. Alignment within 0.001 inch per inch of shaft diameter is normally satisfactory, however, for some critical applications such as high speed, this level of alignment is not acceptable, and a tighter tolerance must be achieved. Please contact our factory, or your coupling vendor, for information regarding your application.

Torque sensor with foot-mounted housing installation

A foot-mounted torque sensor has a plate on its housing, which can be securely attached to a machine base or bedplate. This installation reduces the mass in suspension on the couplings and can increase the shaft's critical speed, if the torque sensor is within its speed rating. Normally, if both the driving and load sources are fully bearing-supported in foot-mounted housings, and the torque sensor housing is foot-mounted, double-flex couplings should be used on each shaft end. Double-flex couplings provide for two degrees of freedom, meaning they can simultaneously allow for angular and parallel misalignment, and reduce the effects of bending on the torque sensor shaft. Half of each coupling weight is supported on the torque sensor's shaft, and the other half is carried by the driving and load shafts.

Technical Information-Torque Sensor

Torque sensor with floating shaft installation

A floating shaft torque sensor does not have a foot-mount plate on the housing, nor is the housing affixed to a bedplate in any other fashion. It depends on being carried by the driver and load shafts for its support. The housing, which is meant to remain stationary and not rotate with the shaft, must be restrained from rotating with a conductive flexible strap. Tapped threaded holes are provided on the side of the housing for this purpose. The other end of the strap is bolted to a bedplate or other stationary-grounded member, which will electrically ground the torque sensor housing to the electrical system ground.

Therefore, with the floating shaft, there is just one degree of freedom between each shaft end of the torque sensor and the adjacent mating shaft, which is bearing-supported (driver and load shafts) on the bedplate. Consequently, a single flex coupling is required at each end of the torque sensor.



Error Analysis

PCB Load & Torque typically supplies accuracy information on its products in the form individual errors. They are non-linearity, hysteresis, non-repeatability, effect of temperature on zero unbalance, and effect of temperature on output.

The customer can combine these individual errors to establish the maximum possible error for the measurement, or just examine the applicable individual error. If the temperature remains stable during the test, the temperature related errors can be ignored. If the sensor is used for increasing load measurement only, ignore the hysteresis error. If the load measurement is near the full capacity, the linearity error can be ignored. If the capability exists to correct the data through linearization-fit or a look-up-table, the error in the measurement can be minimized. A sophisticated user can get rid of all the errors except for the non-repeatability error in the measurement.

Often overlooked by the customer is error due to the presence of non-measured forces and bending moments. Even though the single axis of measurement sensors are designed and built to withstand these non-measured forces and bending moments (extraneous loads), the errors due to them are present. The user can design the set-up to eliminate or minimize these extraneous loads. However, if these extraneous loads are present, the errors due to them should be considered.

Application Questionnaire

Determine the capacity required

- A. What is the maximum expected torque, including transients?
- B. What is the minimum expected torque?
- C. What is the typical expected torque?
- D. What are the dynamics of the system, (i.e. frequency response)?
- E. What are the maximum extraneous loads to which the torque sensor will be subjected?

How will the torque sensor be integrated into the system?

- A. What are the physical constraints, (e.g. length, diameter)?
- B. Will the torque sensor be foot-mounted or floated?
- C. Couplings, torsionally stiff, or torsionally soft?

What type of environment will the torque sensor be operating in?

- A. Maximum temperature?
- B. Minimum temperature?
- C. Humidity?
- D. Contaminants, (e.g. water, oil, dirt, dust)?

What speed will the torque sensor be required to rotate?

- A. What length of time will the torque sensor be rotating, and at what speed?

Services and Qualifications

Lifetime Warranty Plus / Total Customer Satisfaction — PCB® Piezotronics, Inc. guarantees Total Customer Satisfaction through its "Lifetime Warranty Plus", Toll-Free Customer Service, and 24-hour SensorLine™. Contact PCB® for a complete statement of our warranty or view our warranty online at http://www.pcb.com/feedback/tcsg_statement.php.

Toll-Free Customer Service — PCB® offers direct, toll-free telephone numbers for customer use. Specific numbers are available for the area in which your product interest lies. When uncertain, call our general number at 800-828-8840. Customer Service Representatives and Application Engineers are available to assist with requests for product literature, price quotations, discuss application requirements, orders, order status, expedited delivery, troubleshooting equipment, or arranging for returns. Our general fax number is: 716-684-0987. We look forward to hearing from you.

24-hour SensorLine™ — PCB® offers to all customers, at no charge, 24-hour emergency product or application support, day or night, seven days per week, anywhere in the world. To reach a PCB® SensorLine™ Customer Service Representative, call 716-684-0001.

Website - www.pcb.com — Visit us online at www.pcb.com to view a broader selection of products, newly released products, complete product specifications, product drawings, technical information, and literature. Industrial vibration monitoring equipment can also be found on IMI Sensors' web site at www.imi-sensors.com. Sound level meters, noise dosimeters and acoustic measurement systems are featured on Larson Davis' web site at www.larsondavis.com.

AS9100 and ISO 9001 Certifications — PCB® is registered by the Underwriters Laboratory, Inc. as an AS9100:2016 QMS certified by DQS, Inc. and ISO 9001:2015 QMS certified by DQS, Inc. facility and maintains a quality assurance system dedicated to resolving any concern to ensure Total Customer Satisfaction. PCB® also conforms to the former MIL-STD-45662 and MIL-Q-9858.

A2LA Accredited Calibration Facility — PCB Piezotronics microphones, accelerometers, pressure and force transducers are calibrated with full traceability to NIST (National Institute of Standards & Technology) to ensure conformance to published specifications. Certificates of calibration are furnished which include actual measured data. Calibration systems utilized are kept in full compliance with ISO 9001:2015 QMS certified by DQS, Inc. standards. Calibration methods are accredited in accordance with the recognized International Standard ISO/IEC 17025:2005 General Requirements for the Competence of Testing and Calibration Laboratories, as well as AS9100:2016 QMS certified by DQS, Inc. and ISO 10012-1 standards. PCB® also meets requirements of ANSI/NCSL Z540-1-1994 and any additional program requirements in the field of calibration.

Delivery Policy — PCB® is committed to making every effort possible to accommodate all delivery requests. Our extensive in-house production capabilities permit us to manufacture most products to order in a timely fashion. In the event that a specific model is unavailable in the time frame that you need, we can usually offer a comparable unit, for sale or loan, to satisfy your urgent requirements. Many products are available from stock for immediate shipment. Standard cable assemblies and accessory hardware items are always stocked for immediate shipment and PCB® never requires a minimum order amount. If you have urgent requirements, call a factory representative and every effort will be made to fulfill your needs.

Custom Products — PCB® prides itself on being able to respond to customers' needs. Heavy investment in machinery, capabilities, and personnel allow us to design, test, and manufacture products for specialized applications. Please contact us to discuss your special needs.

CE Marking  — Many PCB® products are designed, tested, and qualified to bear CE marking in accordance with European Union EMC Directive. Products that have earned this qualification are so indicated by the  logo.

Hazardous Area Use — Certain equipment is available with ATEX and/or CSA certifications to enable use in hazardous environments. Contact PCB® for detailed specifications, which will identify the specific approved environments for any particular model. 

Accuracy of Information — PCB® has made a reasonable effort to ensure that the specifications contained in this catalog were correct at the time of printing. In the interest of continuous product improvement, PCB® reserves the right to change product specifications without notice at any time. Dimensions and specifications in this catalog may be approximate and for reference purposes only. Before installing sensors, machining any surfaces, or tapping any holes, contact a PCB® application specialist to obtain a current installation drawing and the latest product specifications.

Routine Modification of Standard Models — In addition to the product options noted in our catalogues, customers from all business sectors regularly request adjustments for their specific implementation and measurement needs. PCB® has accommodated customers by making numerous standard adjustments to thousands of sensors, as well as to associated electronics. These adjustments to sensitivity, range, frequency response, resolution, grounding issues, mounting, cabling, and electrical requirements can often be made for a certain premium over the base model.

Stock Products — For the added convenience of our customers, PCB® offers a wide selection of sensors and instrumentation as stock products, available in-house and off the shelf, competitively priced with expedited delivery. These products have been identified and stocked based upon customer demand, with models that offer reliability and versatility across multiple application environments. We also manufacture custom products made to your requirements. We invite our customers to work with our Applications Engineers in evaluating your application first, to see if we might have a stock product alternative that fits your requirements with a short delivery time.

PCB, ICP, IMI with associated logo, TORKDISC, and Modally Tuned are registered trademarks of PCB Piezotronics, Inc. Sensorline is a service mark of PCB Piezotronics, Inc.

PCB® Contact Guide

USA Toll-Free Customer Service:

800-828-8840

International Customers:

716-684-0001

Fax:

716-684-0987

E-mail:

info@pcb.com

PCB® Web Site:

www.pcb.com

PCB® 24-Hour SensorLine™:

716-684-0001



 **PCB PIEZOTRONICS**
AN AMPHENOL COMPANY

3425 Walden Avenue, Depew, NY 14043 USA

pcb.com | info@pcb.com | 800 828 8840 | +1 716 684 0001

© 2023 PCB Piezotronics - all rights reserved. PCB Piezotronics is a wholly-owned subsidiary of Amphenol Corporation. Endevo is an assumed name of PCB Piezotronics of North Carolina, Inc., which is a wholly-owned subsidiary of PCB Piezotronics, Inc. Accumetrics, Inc. and The Modal Shop, Inc. are wholly-owned subsidiaries of PCB Piezotronics, Inc. IMI Sensors and Larson Davis are Divisions of PCB Piezotronics, Inc. Except for any third party marks for which attribution is provided herein, the company names and product names used in this document may be the registered trademarks or unregistered trademarks of PCB Piezotronics, Inc., PCB Piezotronics of North Carolina, Inc. (d/b/a Endevo), The Modal Shop, Inc. or Accumetrics, Inc. Detailed trademark ownership information is available at www.pcb.com/trademarkownership.

TM-Catalog-1123